







2,2. A 125

1885.

Downham  
Cambridge  
Mass

RESPIRATORY THERAPEUTICS



VON ZIEMSEN'S  
HANDBOOK  
OF  
GENERAL THERAPEUTICS

IN SEVEN VOLUMES—VOL. III.

RESPIRATORY THERAPEUTICS

BY

PROF. M. J. OERTEL, M.D.

OF MUNICH

LONDON  
SMITH, ELDER, & CO., 15 WATERLOO PLACE  
1885

9917



# RESPIRATORY THERAPEUTICS

BY

PROFESSOR M. J. OERTEL, M.D.

OF MUNICH

*TRANSLATED FROM THE GERMAN, WITH A PREFACE AND NOTES*

BY

J. BURNEY YEO, M.D., F.R.C.P.

PROFESSOR OF CLINICAL THERAPEUTICS IN KING'S COLLEGE, LONDON : PHYSICIAN  
TO KING'S COLLEGE HOSPITAL : HONORARY FELLOW OF KING'S COLLEGE,  
LONDON : FORMERLY SENIOR ASSISTANT-PHYSICIAN TO THE  
HOSPITAL FOR DISEASES OF THE CHEST, BROMPTON

LONDON

SMITH, ELDER, & CO., 15 WATERLOO PLACE

1885

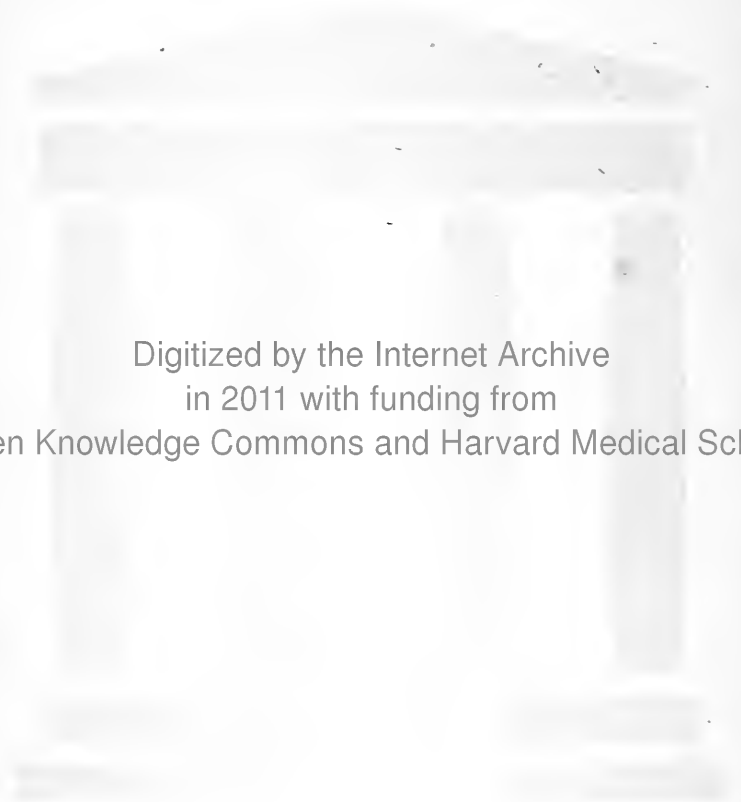

Digitized by the Internet Archive  
in 2011 with funding from  
Open Knowledge Commons and Harvard Medical School

## TRANSLATOR'S PREFACE.

---

VARIOUS methods of treating diseases of the Respiratory Organs by bringing remedial measures into direct contact with them have been promulgated from time to time, but it has only been after many vicissitudes that they have at length found a permanent place in the domain of rational therapeutics.

In this country, perhaps, more than in any other, these methods have encountered, sometimes an active, and at all times an inert resistance, the resistance which determined neglect can always oppose to methods to which it might be impossible to offer a more rational mode of antagonism.

Of the few channels which offer themselves to the physician for the introduction of his remedies into the human body it is a little remarkable with what pertinacity he clings to the upper part of the alimentary canal for the reception of all of them. The mucous membrane of the stomach might well complain of the many difficult duties thus imposed upon it, and against which it does indeed occasionally revolt.

The propriety of applying to the gastric mucous membrane remedies intended to act on the mucous membrane of the air passages might have been defended and maintained at a period before apparatus had been invented by means of which the

same agents could be brought into contact with the respiratory surface; but even after the invention of suitable apparatus for this purpose the possibility of the agents employed ever entering the air passages was by many denied, and with more energy than judgment. The history of this controversy is detailed by Oertel in his introductory chapter.

The devotion of by far the largest volume of Von Ziemssen's 'Handbook of General Therapeutics' to the subject of 'Respiratory Therapeutics' is a timely and unmistakable testimony of the importance which is attached in Germany at any rate to the methods therein described of treating diseases of the respiratory organs; while a glance at the lengthy bibliographical lists to be found in this volume will show what an immense amount of literature has been contributed to this subject by French and Italian writers.

In America Dr. Solis Cohen's volume on 'Inhalations' has acquired a well-merited popularity; but, up to the present moment, no authoritative and systematic work on this subject has been published in England.

It was from considerations such as these that I undertook the very laborious task of presenting to the medical profession in this country an English translation of the elaborate 'Handbuch der Respiratorischen Therapie' of Professor Oertel of Munich.

No doubt the application of medicated vapours and sprays to the respiratory passages is a much more troublesome procedure than the administration of a few doses of medicine by the stomach, and demands much more attention on the part of the patient and much more supervision on the part of the medical attendant; but this is certainly to some extent due to the circumstance that patients have not yet become

familiarised with these methods, or duly impressed with their value; and it would be difficult to offer any sufficient reason why therapeutic methods which have proved of so much value in other countries should not be more widely utilised in our own.

But if the inhalation of vapours and sprays has been too much neglected by English physicians how much more so has this been the case with regard to the application of the pneumatic method to the treatment of pulmonary affections. It is not easy to indicate any readily accessible and really well-appointed and well-managed institution in this country where patients can be sent for pneumatic treatment, whereas in Paris, Berlin, Vienna, St. Petersburg, Nice, Munich, Wiesbaden, and in many other Continental cities an institution of this kind forms an essential part of the physician's resources in dealing with diseases of the respiratory organs.

One of the conspicuous merits of Professor Oertel's work is that he endeavours to supply a rational and scientific as well as an empirical basis for all the methods he recommends, and it may be hoped that the presentation of a work of this kind to the medical profession in England may contribute greatly to the removal of much of the prejudice against these methods which has been fostered amongst us. And it would be well to bear in mind the judicious remark made by Oertel (p. 89) that 'many attempts at treatment by inhalations have not been attended by any satisfactory results, because the quantity of the medicine employed and the duration of its application were not in due ratio to the intensity of the pathological processes with which we have had to deal.'

Of the many interesting and important topics discussed in the following pages I may here call attention to a few which

appear to me of especial and present interest. The successful treatment by Gerhardt of disease of the mitral valve by inhalations of solutions of bicarbonate of soda (p. 56), a method founded on the consideration that the most rapid and effectual way of bringing medicines into contact with the endocardium and the cardiac valves must be through the pulmonary veins, is most suggestive, and it would, as Oertel points out, be scarcely possible, in cases of mycotic endocarditis, to adopt a more rational mode of treatment than to endeavour to exert a direct influence over the bacteroid vegetations in the endocardium and in the cardiac muscle by the administration of inhalations of antiparasitic remedies. The antiphlogistic action of the inhalation of air strongly refrigerated by ice according to the method adopted and advocated by P. Niemeyer is another interesting topic which is here fully examined (p. 109).

The treatment of cases of pleuro-pneumonia, attended with much pleuritic pain, by inhalations of ether or chloroform, a method warmly advocated by the late Sir James Simpson, of Edinburgh, is again brought forward by Oertel (pp. 141 and 328), and deserves more attention than it has hitherto received.

Paul Bert's important observations on the inhalation of nitrous oxide gas under increased pressure is referred to at p. 143.

The solvent action of inhalations of lime water, lactic acid, neurine, papayotine, and other substances on croupous and diphtheritic membranes is another highly important practical question which is here fully examined (p. 185 et seq.)

It is moreover especially interesting to read Professor Oertel's frank conviction of the parasitic nature of such diseases as whooping cough and diphtheria, as well as his account of the eminent success which has attended his treatment of these

diseases by antiparasitic inhalations. His observations on the use of carbolic acid inhalations in diphtheria (p. 274) merit the most attentive consideration.

The value of antiseptic and disinfecting inhalations in phthisis is largely dwelt upon and firmly maintained; and the employment of continuous inhalations of an atmosphere impregnated with antiseptic vapours by means of the respirator inhaler finds in Oertel a rational and consistent advocate. This last method has recently encountered a certain amount of superficial and inexperienced criticism, but it would be an endless and profitless labour to be for ever replying to strictures such as these.

My own experience on this point, as well as that of many other careful observers in this country, is entirely in accord with the evidence presented by Oertel in this volume.

It only remains for me to offer my best thanks to those who have kindly afforded me important help in this somewhat arduous undertaking, and especially to Dr. PHILIP FRANK and Dr. FELIX SEMON; also to Miss M. A. ANDREWS, without whose ready and valuable aid I could not, with so many other calls upon my time, have completed my task within anything approaching a reasonable period.

J. BURNEY YEO.

HERTFORD STREET, MAYFAIR:

*May* 1885.





# CONTENTS

OF

## THE THIRD VOLUME.

	PAGE
INTRODUCTION . . . . .	3
HISTORY . . . . .	6
First Period . . . . .	7
Second Period . . . . .	9
Third Period . . . . .	10
Fourth Period . . . . .	11
Fifth Period . . . . .	14

### I. THE CHEMICAL PART OF RESPIRATORY THERAPEUTICS.

INHALATIONS . . . . .	19
TREATMENT OF DISEASES OF THE RESPIRATORY ORGANS BY THE INHALATION OF CHEMICAL OR PHARMACOLOGICAL REMEDIES . . . . .	19
BIBLIOGRAPHY . . . . .	19
ANATOMICAL DISPOSITION OF PARTS IN RELATION TO THE INHALATION OF MEDICINAL SUBSTANCES . . . . .	23
ON THE PENETRATION OF FOREIGN BODIES INTO THE AIR	
PASSAGES . . . . .	29
A. SOLID BODIES . . . . .	29
B. FLUIDS . . . . .	35
(a) Experiments on Animals . . . . .	37
(b) Observations on Men . . . . .	38
(c) Experiments with Artificial Apparatus . . . . .	43
C. GASES AND VAPOURS . . . . .	46
MODE OF ACTION OF MEDICINAL BODIES INTRODUCED BY INHALATION . . . . .	49
SPECIAL ACTION OF INHALATIONS . . . . .	50
1. Of Vapourisable Bodies . . . . .	50
2. Of Solid Bodies . . . . .	51
3. Of Fluids . . . . .	54
4. Of Vapours and Mists . . . . .	60

	PAGE
APPARATUS . . . . .	61
I. FOR THE PULVERISATION AND INHALATION OF MEDICATED FLUIDS . . . . .	61
1. Sales-Girons' Apparatus . . . . .	61
2. Matthieu and Bergson's Apparatus . . . . .	64
3. Siegle's Apparatus . . . . .	68
Steam Spray-producing Apparatus of Improved Construction . . . . .	71
DIFFERENCES IN THE WORKING OF THE DIFFERENT APPARATUS AND INDICA- TIONS FOR THEIR USE . . . . .	77
a. Differences . . . . .	77
b. Indications . . . . .	80
II. APPARATUS FOR THE DEVELOPMENT AND INHALATION OF VAPOURS . . . . .	82
MEDICATED RESPIRATORS FOR CONTINUOUS INHALATION . . . . .	87
Medicated Cigars . . . . .	93
III. APPARATUS FOR THE INHALATION OF GASES . . . . .	93
IV. APPARATUS FOR THE INHALATION OF SOLID SUBSTANCES . . . . .	98
MODES OF PRACTISING INHALATION . . . . .	100
NUMBER AND DURATION OF THE INHALATIONS. DOSES . . . . .	104
REMEDIES ADAPTED FOR INHALATION . . . . .	109
1. REMEDIES WHICH WITHDRAW HEAT . . . . .	109
a. Cold Air . . . . .	109
b. Cold Water . . . . .	116
2. EMOLLIENT REMEDIES . . . . .	119
MEDICINAL SUBSTANCES . . . . .	124
1. Moist Heat, Steam, Aqueous Mists, Hot Water . . . . .	124
2. Gum Arabic . . . . .	125
3. Glycerine . . . . .	125
4. Oily Emulsions . . . . .	125
3. NARCOTIC REMEDIES . . . . .	125
MEDICINAL SUBSTANCES . . . . .	130
1. Opium and its Preparations . . . . .	131
2. Extractum Hyoscyami . . . . .	132
3. Extractum Conii Maculati . . . . .	133
4. Stramonium . . . . .	133
5. Cannabis Indica . . . . .	135
6. Tobacco . . . . .	136
7. Hydrocyanic Acid . . . . .	136
8. Bromide of Potassium and Bromide of Ethyl . . . . .	137
9. Ether and Chloroform . . . . .	139
10. Nitrous Oxide . . . . .	142
11. Nitrite of Amyl . . . . .	145

	PAGE
4. ASTRINGENT, STYPTIC, AND CAUSTIC REMEDIES . . . . .	147
MEDICINAL SUBSTANCES . . . . .	153
1. Tannic Acid . . . . .	153
2. Alum . . . . .	155
3. Chloride of Iron . . . . .	157
4. Nitrate of Silver . . . . .	158
5. Neutral Acetate of Lead . . . . .	160
6. Sulphate of Zinc . . . . .	161
7. Sulphate of Copper . . . . .	162
8. Sulphate of Iron . . . . .	163
9. Tincture of Malate of Iron . . . . .	163
5. SOLVENT SUBSTANCES . . . . .	163
MEDICINAL SUBSTANCES . . . . .	170
1. Common Salt . . . . .	171
2. Sal Ammoniac . . . . .	172
3. Carbonate of Potassium and Sodium . . . . .	175
4. Carbonate of Lithium . . . . .	176
5. Chlorate of Potassium . . . . .	177
6. Nitrate of Potassium and Sodium. Nitre Fumes . . . . .	177
7. Sulphide of Potassium and Sodium . . . . .	180
8. Ammonia. Caustic Solution of Ammonia . . . . .	181
9. Lime Water . . . . .	183
10. Lactic Acid . . . . .	185
11. Neurine. Hydroxide of Trimethyl-vinyl-ammonium . . . . .	185
12. Hydroxide of Tetramethyl-ammonium. Hydroxide of Tetra-ethyl-ammonium . . . . .	186
13. Succus Caricæ Papayæ L. . . . .	186
14. Papayotine . . . . .	187
6. STIMULATING, ANTISEPTIC, AND ANTIPUTRESCENT REMEDIES . . . . .	188
MEDICINAL SUBSTANCES . . . . .	198
a. STIMULATING REMEDIES . . . . .	198
1. Tar . . . . .	198
2. Turpentine . . . . .	200
3. Balsams : of Peru, of Tolu, of Copaiva . . . . .	203
b. ANTISEPTIC AND ANTIPUTRESCENT REMEDIES . . . . .	204
1. Chlorine . . . . .	204
2. Bromine . . . . .	206
3. Boracic Acid . . . . .	207
4. Permanganate of Potash . . . . .	207
5. Benzole. Benzine . . . . .	208
6. Creosote. Creosote Water . . . . .	209
7. Benzoic Acid . . . . .	210
7a. Benzoate of Soda . . . . .	211
8. Phenol. Carbolie Acid . . . . .	212
9. The Dioxy-benzole Series . . . . .	217
10. Salicylic Acid . . . . .	221
11. Thymol . . . . .	222
12. Eucalyptol. Oleum Eucalypti le Foliis . . . . .	223

	PAGE
7. NERVINE REMEDIES . . . . .	225
MEDICINAL SUBSTANCES . . . . .	226
1. Caustic Ammonia . . . . .	226
2. The Various Ethers . . . . .	226
3. Acetone . . . . .	226
4. Camphor . . . . .	226
5. Oleum Animale Æthereum . . . . .	227
6. Aqua Asafœtidæ . . . . .	227
7. Aqua Castorei . . . . .	227
8. CONSTITUTIONAL REMEDIES . . . . .	227
1. Iodide of Potassium. Iodine. Tincture of Iodine . . . . .	227
2. Corrosive Sublimate . . . . .	230
3. Arsenic. Arsenite of Potassium. Fowler's Solution. Arsenite of Sodium. Pierson's Arsenical Solution . . . . .	233
9. MINERAL WATERS . . . . .	234
1. Alkaline Waters . . . . .	234
2. Common Salt Waters . . . . .	237
3. Sulphur Waters . . . . .	237
10. GASES . . . . .	238
1. Oxygen . . . . .	238
2. Nitrogen . . . . .	247
3. Hydrogen . . . . .	251
4. Carbonic Acid . . . . .	251
5. Sulphuretted Hydrogen . . . . .	253

THE TREATMENT OF SPECIAL MALADIES BY INHALATION . 255

A. HÆMORRHAGES FROM THE RESPIRATORY ORGANS . . . . .	255
1. Hæmorrhage from the Nasal Passages . . . . .	256
2. Hæmorrhage from the Mouth and Pharynx . . . . .	256
3. Hæmorrhage from the Larynx and Trachea . . . . .	259
4. Hæmorrhage from the Bronchi and Lungs . . . . .	259
B. DISEASES OF THE NASAL PASSAGES . . . . .	263
1. Acute Catarrh . . . . .	263
2. Chronic Catarrh . . . . .	264
C. DISEASES OF THE MOUTH AND PHARYNX . . . . .	266
1. Acute Catarrhal and Erythematous Angina. Acute Pharyngeal Catarrh . . . . .	266
2. Chronic Pharyngeal Catarrh . . . . .	267
3. Granular, Follicular Pharyngeal Catarrh . . . . .	270
4. Hyperplastic Pharyngitis . . . . .	272
5. Phlegmonous Angina and Pharyngitis . . . . .	272
6. Diphtheria of the Mouth and Pharynx . . . . .	273
7. Oral and Pharyngeal Ulcerations . . . . .	282
8. Syphilitic Diseases of the Mouth and Pharynx . . . . .	283

	PAGE
D. DISEASES OF THE LARYNX . . . . .	284
1. Acute Laryngeal Catarrh . . . . .	284
2. Chronic Laryngeal Catarrh . . . . .	285
3. Laryngeal Ulceration . . . . .	287
4. Parenchymatous Inflammation of the Larynx, Perichondritis, Œdema, and Abscess of Larynx . . . . .	289
5. Diphtheria of the Larynx and Deeper Air Passages . . . . .	290
6. Croupous Inflammation of the Larynx and of the Deeper Air Passages . . . . .	295
7. Laryngeal Phthisis . . . . .	296
(a) Acute and Subacute Catarrh . . . . .	299
(b) Chronic Catarrh . . . . .	299
(c) Ulceration . . . . .	300
(d) Perichondritis and Œdema . . . . .	304
(e) Tuberculosis . . . . .	305
8. Syphilitic Affections of the Larynx . . . . .	307
9. Laryngeal Neuroses . . . . .	308
E. DISEASES OF THE BRONCHI . . . . .	309
1. Acute Bronchial Catarrh . . . . .	309
2. Chronic Bronchial Catarrh . . . . .	310
3. Bronchorrhœa and Putrid Bronchitis . . . . .	312
4. Bronchiectasis . . . . .	315
5. Croup and Diphtheria of the Bronchi . . . . .	317
6. Pertussis . . . . .	318
7. Emphysema and Asthma . . . . .	322
F. DISEASES OF THE LUNGS . . . . .	327
1. Pneumonia . . . . .	327
2. Gangrene of Lungs . . . . .	330
3. Diseases associated with Pulmonary Consumption . . . . .	333
(a) Prophylaxis . . . . .	334
(b) Acute and Subacute Catarrhs . . . . .	340
(c) Catarrh of the Apex . . . . .	341
(d) Chronic Bronchial Catarrh . . . . .	342
(e) Desquamative Pneumonia . . . . .	343
(f) Peribronchitis and Broncho-pneumonia . . . . .	349
(g) Broncho-pneumonic Ulceration, Phthisis Proper . . . . .	350
(h) Mycotic Affections of the Lung . . . . .	358
(i) Tuberculosis . . . . .	361

---

## II. THE PHYSICAL PART OF RESPIRATORY THERAPEUTICS.

	PAGE
PNEUMATIC THERAPEUTICS . . . . .	367
TREATMENT OF DISEASES OF THE RESPIRATORY AND CIRCULATORY ORGANS BY ALTERATIONS OF AIR PRESSURE . . . . .	367

## SECTION I.

ALTERATIONS OF AIR PRESSURE ACTING ONLY ON THE PULMONARY SURFACE ('EINSEITIG'<sup>1</sup>), SIMPLE AND COMBINED, BY MEANS OF THE PORTABLE APPARATUS.

A. METHOD REQUIRING THE CO-OPERATION OF THE PATIENT . . . . .	367
BIBLIOGRAPHY . . . . .	367
INTRODUCTION . . . . .	372
APPARATUS . . . . .	375
(a) BOILER APPARATUS . . . . .	376
1. Hauke's Apparatus . . . . .	376
2. Störk's Apparatus . . . . .	380
(b) APPARATUS CONSTRUCTED ON THE GASOMETER PRINCIPLE . . . . .	380
1. Waldenburg's Apparatus . . . . .	380
2. Cube's Double Apparatus . . . . .	388
3. Tobold's Apparatus . . . . .	392
4. Weil's Double Apparatus . . . . .	393
5. Schnitzler's Apparatus . . . . .	394
(a) The Simple Apparatus . . . . .	394
(b) The Continuously Acting Apparatus . . . . .	399
6. Finkler and W. Kochs' Apparatus . . . . .	407
(c) APPARATUS CONSTRUCTED ON THE BELLOWS PRINCIPLE . . . . .	410
1. Biedert's Apparatus . . . . .	410
Mode of Application . . . . .	412
2. B. Fränkel's Apparatus . . . . .	416
(d) APPARATUS ON THE PRINCIPLE OF THE WATER-ENGINE BELLOWS <sup>2</sup> . . . . .	417
A. Geigel and A. Mayr's Double Ventilator . . . . .	417
The Small Portable Apparatus . . . . .	433
PRACTICAL APPLICATION OF THE PNEUMATIC METHOD . . . . .	436

<sup>1</sup> Oertel uses the word *einseitig* ('partial' or 'one-sided') for air pressure acting only on the pulmonary surface; when it acts on the *general* surface of the body as well as on the pulmonary surface he uses the word *allseitig*.—Tr.

<sup>2</sup> *Schöpf- und Fradgebälse*. There is no exact English equivalent for this word.—Tr.

	PAGE
ACTION OF VARIATIONS OF AIR PRESSURE APPLIED TO THE PULMONARY SURFACE . . . . .	441
I. MECHANICAL INFLUENCE ON RESPIRATION . . . . .	441
1. Inspiration of Compressed Air . . . . .	441
2. Expiration into Compressed Air . . . . .	448
3. Inspiration of Rarefied Air . . . . .	451
4. Expiration into Rarefied Air . . . . .	454
II. MECHANICAL ACTION OF THE HEART AND THE CIRCULATION . . . . .	461
1. Inspiration of Compressed Air . . . . .	461
2. Expiration into Compressed Air . . . . .	480
3. Inspiration of Rarefied Air . . . . .	487
4. Expiration into Rarefied Air . . . . .	494
III. DYNAMIC ACTION . . . . .	503
IV. CHEMICO-PHYSIOLOGICAL ACTION . . . . .	505
V. COMBINATIONS OF THE DIFFERENT MODES OF APPLICATION . . . . .	508
1. Action on Respiration . . . . .	511
2. Action on the Heart and Circulation . . . . .	514
MODIFICATIONS OF THE METHOD . . . . .	516
1. Alteration of the Physical Condition of Condensed Inspiratory Air . . . . .	517
2. Alteration of the Chemical Constituents of Condensed Inspiratory Air . . . . .	518
(a) Increase of the several Gaseous Constituents of Atmospheric Air . . . . .	518
(b) Combination of Volatile Medicinal Substances with Compressed Air . . . . .	519
RANGE OF APPLICATION OF ALTERED AIR PRESSURE ACTING ON THE PULMONARY SURFACE ONLY . . . . .	521
1. Indications . . . . .	521
2. Counter-indications . . . . .	523
SPECIAL THERAPEUTICS OF ALTERED AIR PRESSURE APPLIED BY MEANS OF APPARATUS TO THE PULMONARY SURFACE . . . . .	524
(A) IN DISEASES OF THE RESPIRATORY ORGANS . . . . .	524
1. Respiratory Insufficiency . . . . .	524
2. Chronic Bronchial Catarrh . . . . .	528
3. Acute Bronchial Catarrh . . . . .	534
4. Emphysema . . . . .	535
5. Bronchial Asthma . . . . .	546
6. Pleuritis and Empyema . . . . .	551
7. Diseases Connected with Pulmonary Phthisis . . . . .	556
(a) The Phthisical Habit . . . . .	556
(b) Apex Catarrh . . . . .	560
(c) Peribronchitis and Chronic Inflammatory Infiltrations of the Lung . . . . .	561
(d) Desquamative Pneumonia and Broncho-pneumonic Ulceration . . . . .	562

	PAGE
(b) IN DISEASES OF THE HEART AND ORGANS OF THE CIRCULATION . . . . .	565
(a) Hyperæmia of the Pulmonary Circulation . . . . .	566
1. In Mitral Insufficiency and Stenosis . . . . .	567
2. Insufficiency and Stenosis of the Aortic Valves . . . . .	570
3. Fatty Heart . . . . .	572
4. In Passive Hyperæmia of the Lungs from Cardiac Affec- tions, leading to Chronic Hæmoptysis . . . . .	572
5. Pulmonary Engorgement Induced by Secondary Fluxions . . . . .	573
(b) Insufficient Fulness of the Pulmonary Circulation . . . . .	573
ALTERATIONS OF AIR PRESSURE ON THE PULMONARY SUR- FACE EFFECTED WITHOUT APPARATUS . . . . .	
1. Deepened and Prolonged Inspirations . . . . .	575
2. Prolonged Expirations . . . . .	580
3. Valsalva's Experiment . . . . .	583
4. Müller's Experiment . . . . .	584
5. Involuntary Respiratory Exercises in Walking and Climbing . . . . .	585
B. COMPULSORY AND INVOLUNTARY METHOD . . . . .	587
BIBLIOGRAPHY . . . . .	587
I. ACTION OF NEGATIVE PRESSURE ON THE THORACIC SUR- FACE . . . . .	
APPARATUS . . . . .	589
1. The Pneumatic 'Panzer' . . . . .	590
2. The Pneumatic 'Wanne' . . . . .	590
Hauke's Pneumatic Apparatus . . . . .	591
MODE OF ACTION . . . . .	594
1. Theory of Forced Inspiratory Expansion of the Thorax . . . . .	596
2. Experiments on the Dead Body and Therapeutic Researches . . . . .	598
INDICATIONS . . . . .	600
1. Asphyxia . . . . .	601
2. Congenital Atelectasis . . . . .	601
3. Catarrhal, Chronic, and Croupous Pneumonia and Pleuro-pneu- monia . . . . .	602
4. Chronic Stationary Pleuritic Exudations . . . . .	603
5. Croup . . . . .	605
6. Rickets . . . . .	606
II. ACTION OF POSITIVE PRESSURE ON THE SURFACE OF THE THORAX . . . . .	
	607

## SECTION II.

CHANGES OF AIR PRESSURE ACTING GENERALLY IN THE PNEUMATIC  
CHAMBER.

BIBLIOGRAPHY . . . . .	612
A. CONDENSED AIR . . . . .	618
PNEUMATIC CHAMBERS (BELLS, CABINETS) . . . . .	618



	PAGE
CONSTRUCTION OF THE PNEUMATIC CHAMBERS . . . . .	619
1. Tabarié's Apparatus . . . . .	619
2. G. Lange's Apparatus (v. Vivenot) . . . . .	622
3. G. v. Liebig's Apparatus at Reichenhall . . . . .	624
4. Simonoff's Apparatus at St. Petersburg . . . . .	629
MANAGEMENT AND USE OF THE PNEUMATIC CHAMBERS . . . . .	630
PHYSICAL CHANGES OF THE AIR IN THE CHAMBER THROUGH INCREASE OF ATMOSPHERIC PRESSURE . . . . .	635
Aqueous Vapour . . . . .	636
Rise of Temperature in the Air . . . . .	636
ACTION OF INCREASED AIR PRESSURE ON THE ANIMAL BODY . . . . .	639
(A) MECHANICO-PHYSIOLOGICAL ACTION . . . . .	640
1. Action on the Organs of Sense . . . . .	640
2. Action on the Organs of Respiration . . . . .	642
(a) With Increasing Pressure . . . . .	642
(b) With Constant Pressure . . . . .	644
(c) With Diminishing Pressure . . . . .	646
3. Action on the Mechanism of Respiration . . . . .	647
(a) On the Respiratory Movements . . . . .	647
(b) On the Mobility of the Thorax . . . . .	650
(c) On the Vital Capacity . . . . .	650
4. Action on the Organs of Circulation . . . . .	652
(a) On the Heart and the Circulation generally . . . . .	652
(b) On the Peripheral Vascular System . . . . .	654
(c) On the Pulse . . . . .	655
(d) On the Blood Pressure in the Vessels . . . . .	660
(e) On the Central Vessels . . . . .	663
(f) On the Veins, Capillaries, and Lymphatics . . . . .	666
(g) On Secretion and Absorption . . . . .	667
(B) CHEMICO-PHYSIOLOGICAL ACTION . . . . .	668
(a) On the Exchange of Gases . . . . .	669
(b) On Oxidation and Generation of Heat . . . . .	671
(c) On Tissue Change and Nutrition in General . . . . .	673
Estimation of Urea . . . . .	676
(d) Influence of Improved Nutrition on Muscular Force and on the Elasticity of the Lung Tissue . . . . .	679
ACTION OF PRESSURE IN PASSING FROM A DENSER TO A RARER AIR . . . . .	681
THERAPEUTIC USE OF COMPRESSED AIR IN THE PNEU- MATIC CHAMBER . . . . .	683
INDICATIONS AND COUNTER-INDICATIONS . . . . .	683

	PAGE
(A) EMPLOYMENT SPECIALLY OF ITS MECHANICAL ACTION . . . . .	685
1. IN ACUTE AND SUBACUTE INFLAMMATIONS OF THE RESPIRATORY MUCOUS MEMBRANE . . . . .	685
Acute Laryngeal and Bronchial Catarrh . . . . .	686
2. IN CHRONIC AFFECTIONS . . . . .	687
(a) Chronic Bronchial Catarrh . . . . .	688
(b) Pulmonary Emphysema . . . . .	691
(c) Bronchial Asthma . . . . .	694
(d) Diseases connected with Pulmonary Consumption . . . . .	695
1. The Phthisical Habit . . . . .	696
2. Catarrh of the Apex and Peribronchitis . . . . .	697
3. Chronic Parenchymatous Inflammation of the Lungs, Chronic Desquamative Pneumonia . . . . .	698
4. Lobular Caseous Inflammation of the Lungs and Bron- cho-pneumonic Ulceration . . . . .	700
5. Pulmonary Hæmorrhage . . . . .	701
(e) Pleuritic Exudations . . . . .	703
(f) Organic Diseases of the Heart . . . . .	705
(B) UTILISATION OF THE CHEMICO-PHYSIOLOGICAL ACTION . . . . .	706
1. In Obesity . . . . .	707
2. In Anæmia and Chlorosis . . . . .	708
3. In Whooping Cough . . . . .	709
FURTHER APPLICABILITY OF CONDENSED AIR IN THE PNEUMATIC CHAMBER . . . . .	709
B. RAREFIED AIR . . . . .	710
EMPLOYMENT OF RAREFIED AIR IN GENERAL . . . . .	710
EXPIRATION FROM A DENSER INTO A RARER AIR . . . . .	711
RAREFIED AIR IN THE PNEUMATIC CHAMBER . . . . .	715
MECHANICAL AND CHEMICO-PHYSIOLOGICAL ACTION OF RAREFIED AIR . . . . .	715
(a) On Respiration . . . . .	715
(b) On the Circulation . . . . .	718
(c) On Change of Tissue . . . . .	722
(d) On the Brain, the Spinal Cord, and the General Condition . . . . .	725
INDICATIONS FOR THE EMPLOYMENT OF RAREFIED AIR . . . . .	727
THERAPEUTIC USES OF RAREFIED AIR . . . . .	729
INDEX . . . . .	733

# RESPIRATORY THERAPEUTICS

BY

M. J. OERTEL, M.D.

PROFESSOR IN THE UNIVERSITY OF MUNICH

TRANSLATED FROM THE GERMAN, WITH NOTES AND A PREFACE

BY

J. BURNEY YEO, M.D.

FELLOW OF THE ROYAL COLLEGE OF PHYSICIANS ; HON. FELLOW OF KING'S COLLEGE,  
LONDON ; PHYSICIAN TO KING'S COLLEGE HOSPITAL ; FORMERLY  
SENIOR ASSISTANT PHYSICIAN TO THE HOSPITAL FOR  
DISEASES OF THE CHEST, BROMPTON



## INTRODUCTION.



THE physiological functions of the respiratory organs enable us to bring into contact with the mucous membrane of the respiratory tract, as well as with the pulmonary surface, various substances, provided they are sufficiently minutely subdivided to be borne along by the current of air; we can also produce differences in the pressure of the air, either by condensation or rarefaction of the respiratory air alone, or more generally by elevation or depression of atmospheric pressure, acting simultaneously upon the general surface of the body as well as upon the lungs.

The advantages attending the utilisation of such means in the treatment of diseases of the respiratory organs will no doubt be very considerable, and the numerous futile but ever-renewed attempts in past centuries plainly show how clear to the minds of the physicians of those times was the value of a system of local treatment of this nature, as well as how difficult its realisation was on account of the imperfection and incompleteness of the instruments at their disposal.

It was not till within the last twenty years that the problem of those old practitioners received a satisfactory solution, by the invention of ingenious apparatus which made it possible to apply medicines in a fluid form, as well as to carry out a mechanical treatment by means of pressure and suction, acting especially upon the surface of the lungs. Emollient and astringent remedies have thus been applied without difficulty to the swollen and inflamed respiratory mucous membrane; the liquefaction and expectoration of the viscid muco-purulent secretions

in the bronchi have been easily effected by alkaline solutions; putrefactive decompositions have been averted by disinfecting agents, and hæmorrhages have been arrested by the direct action of styptics; while by increasing the atmospheric pressure we have produced a mechanical dilatation of the lungs and thorax, and by the exhausting action of rarefied air a contraction of the pulmonary tissue, and thus increased the vital capacity of the lungs; we have also been able to diminish or increase the fulness of the pulmonary vessels and to produce a corresponding alteration in the state of the circulation. These two methods, then, which came into use very soon one after the other, mutually and necessarily supplement each other. However remarkable may have been the favourable results obtained by the inhalation of medicinal substances into the respiratory organs, this treatment proved quite insufficient in a number of diseases, as, for example, in emphysema, and this justified the desire for the completion of the new system, a desire realised by the introduction of the pneumatic method of treating pulmonary diseases, a system which works efficaciously in those very cases where medicinal substances either fail or at least fulfil very insufficiently the indications present. But, on the other hand, if the pneumatic method is to achieve thoroughly effectual results, it cannot dispense with the application of pharmaceutical remedies in vapour or solution. This is most strikingly exemplified in the case of emphysema itself, in which the pneumatic method obtains its greatest achievements. And yet the co-existent chronic catarrhs, blenorrhagic conditions of the bronchi, putrid expectoration, &c., necessitate the application of remedies for reducing and disinfecting the secretions, such as carbolic acid, oil of turpentine, &c. Similarly we cannot dispense with either of these methods in the treatment of pulmonary phthisis, from its prophylactic treatment up to the treatment of its later stages, at least if we would do all that can now be done for our patients in this, the gravest of all diseases of the respiratory organs.

Treatment by inhalation, by the use of pharmaceutical remedies in the form of vapour and atomised solutions, as well as pneumatic treatment, i.e. utilisation of the physico-mechanical properties of atmospheric pressure for the treatment of diseases

of the respiratory, and also in part of the circulatory organs, form, taken together, a distinct section of general therapeutics, which must be grasped and treated as a whole, if we would do justice to both and to the advantages to be derived from them. The domain of respiratory therapeutics would thus comprehend both the physical and chemical methods, which are mutually related and supplementary to each other.

I shall endeavour, so far as I am able, in the following exposition of respiratory therapeutics, to give a faithful description of the details of these two methods, considered separately as well as in their combined application.

## HISTORY.

ATTEMPTS to produce beneficial results on the respiratory organs by inhalations in some form or other may be traced far back into antiquity, and the history of inhalatory treatment is as old as the history of medicine itself.

These attempts were founded upon an experience dating from quite ancient times, that greater and surer results were attained by a direct system of treatment than by the internal administration of drugs. Thus we find these efforts in all periods of the history of medicine, and we may observe a progressive development of them keeping pace with the development of our medical and scientific knowledge, as well as with the growth of our mechanical appliances. For many centuries these endeavours, as indeed the practice of medicine generally, ran in the groove of the old traditional nostrums, or such as were devised by the fantastic speculation and the uncritical empiricism of those times. Later on the advance of our chemical and physical knowledge, together with the discovery of new drugs and remedies, gave a fresh impulse to these efforts, while the extension of our pharmacological, physiological, and pathological knowledge, as well as the improvement of our means of diagnosis, combined with a more comprehensive appreciation of the various chemical and physico-mechanical remedies, led to a sharper definition of indications, and thereby made it possible to draw a clearer line of demarcation between results within the reach of therapeutics and mere fruitless efforts.

When, therefore, we regard the experiments in the domain of respiratory therapeutics from a historical point of view, we may divide them into different periods, not indeed capable of being sharply marked off from one another, but which, by the progress seen to characterise them, may give one a bird's-eye view of the development of this branch of medicine.



*First Period.*

This period of the history of respiratory therapeutics may be most conveniently considered as extending from the beginning of our historical knowledge to the middle of the seventeenth century.

It was quite in character with the knowledge and the ideas of those times that only such medicines should be chosen for inhalation as volatilised readily on elevation of temperature, and, by their penetrating odour, made themselves very evident to the senses; especially vapours from balsamic and aromatic drugs, such as resinous, sulphurous, and arsenical vapours.

The employment of fumigations in the ancient world for religious purposes, as incense and for exorcising evil demons, in whom diseases were personified, offered abundant suggestions for their use as healing media, so that as early as Homer we find mention of sulphurous vapours as popular antimiasmatics and disinfectants, *κακῶν ἄκος*, a remedy against disease. Hippocrates appears to have made considerable use of fumigations. He assigns to them the first place in many maladies, as in acute angina; he employs them in various pulmonary affections, and even mentions a simple apparatus for their application. A pot with a perforated lid, through which a reed is passed, serves for the development of the vapours which are inhaled through the open mouth, while wet sponges protect the neighbourhood of the mouth from heat.

We also learn from the works of Aretæus that the inhalation of sea air was recommended in very early times as a cure for phthisis, because sea water was supposed to exercise a desiccant and healing influence on the actively secreting mucous membrane and lung.

In the succeeding centuries fumigations almost passed into desuetude in diseases of the respiratory organs. They were used more in the treatment of other maladies, and Waldenburg found only one place in Celsus in which fumigations were recommended, and that was in ulceration of the fauces; the inhalation of sea air for pulmonary complaints had again lost its importance, and the chief benefit to be derived from sea

voyages was supposed to depend on the long journey and the rocking motion, which could be as well obtained by being carried in a litter. In the works of Pliny we find but little mention of the use of fumigations in pulmonary affections; he recommends such patients to reside in pine woods, advises fumigations from pine cones as a good expectorant, and holds the same view as Celsus with regard to sea voyages.

Again, during the whole lifetime of Galen, who employs warm vapours for angina and makes use of the fumigating apparatus of Hippocrates, fumigations themselves and inhalations of vapour seem to have been very little used in diseases of the more deeply seated parts of the respiratory organs. On the other hand, Galen returns to the recommendation of residence on the sea coast for patients in pulmonary phthisis as well as for those who suffer from ulcers in the larynx and the trachea, and advises them to settle in the neighbourhood of Vesuvius towards Stabiæ, the modern Portici, and in Sicily in the vicinity of Etna, so as to inhale the sulphurous vapour as well as the sea air.

It was not until the third and fourth century of our era that Antyllus again had recourse to fumigations in the treatment of diseases of the respiratory organs, and adopts them, especially for asthma and orthopnœa, proceeding from mucous obstruction, whereas he considers them counterindicated in hæmoptysis and dry cough. Marcellus Empiricus also made use of fumigations towards the end of the fourth century, and adopted an apparatus similar to that of Hippocrates.

From this time we find efforts in the domain of respiratory therapeutics confined to the Arabs, especially in the ninth century, the period of the full development of Arabic medical science, when the great Rhazes made use of fumigations, chiefly of balsamic drugs, for pulmonary affections, while during the whole of the Middle Ages these experiments were at a standstill and passed into oblivion. It was not till the end of the fifteenth and beginning of the sixteenth century that Johann de Vigo, when syphilis first appeared in Italy, discovered and recommended mercurial fumigations as the best remedy for this disease.

*Second Period.*

Respiratory treatment was again taken up scientifically and introduced into medical practice by Bennet about the middle of the seventeenth century: he declared this method of treatment to be the best remedy against phthisis, and adopted two modes of fumigation, one of which, prepared by infusions of aromatic herbs, he distinguished as *halitus*, and the other, in which dry balsamic vapours were developed, as *suffitus*. Thus at length a distinct method had been engrafted on the empiric experiments of the ancients, and Bennet's successor, Willis, instituted several kinds of inhalations, beginning the treatment with emollient vapours and gradually introducing balsamic, sulphurous, and finally arsenical vapours.

When about the same time, in the sixteenth and seventeenth centuries, the physical properties of the air, which had been long recognised by Aristotle, were referred to fixed laws by Galilei, Torricelli, Pascal, Otto von Guericke, Boyle, and Mariotte, it was no longer possible to overlook the influence of atmospheric pressure on the animal organism, and observations of different symptoms in man and beast under altered atmospheric pressure led finally, after many theoretical speculations, to the idea of modifying the *degree of density* of the air for *curative purposes*.

The idea was first reduced to practice by the English physician Dr. Henshaw, who in 1664 constructed his *domicilium*, a house built of tiles, in which by means of large organ pipes he was able to condense or rarefy the air according to a barometer which was fixed up there. The condensed air was employed by Henshaw in acute, the rarefied in chronic cases, and applied up to the degree at which it could be borne without inducing difficulty of breathing.

According to his observations, residence in the *domicilium* was indicated in intermittent fevers, during the attack, in states of health to promote change of tissue, but above all in pulmonary diseases, and lastly for accommodation in the transition from a climate with rarer air to the home climate with denser air after long journeys. The results obtained by Henshaw have not been published. At any rate they were not very remarkable,

and consequently they did not meet with general practical appreciation, nor did they lead to later observations in that direction.

After these preliminary labours, as well in the chemical as the physical direction, the importance of local treatment of the respiratory organs in the further development of medicine was more and more recognised, and Mascagni expressed the opinion that, if ever a specific against phthisis was to be discovered, it must be introduced into the organism through the air tubes.

Yet these ideas have never met with full acceptance in medical practice, because the school which then governed medicine and the slight medical and scientific knowledge of physicians in general were in opposition to them, so that only the most eminent men carried on these experiments, till the discoveries of rapidly advancing chemical science introduced new remedies of great promise, and so gave a fresh and general impulse to the investigation.

### *Third Period.*

When, about the middle of the last century, oxygen was discovered by Priestley and Scheele, as well as a series of other gases, it was especially oxygen and the intoxicating nitrous oxide which were tried in various forms of pulmonary disease and raised the most extravagant hopes. Priestley himself recommended the use of oxygen gas, dephlogisticated air or the air of life, as this new gas was also called, for inhalation in chest diseases, and Fothergill, Caillens, Fourcroy, Stoll, and others found these inhalations to be temporarily useful for consumptive patients, but desisted from the application of them from the fear which had been already expressed by Priestley that a more rapid consumption of the vital powers might be induced by the oxygen.

The whole method of inhalation employed at that time was reduced to practical application by Thomas Beddoes at Clifton, in whose institution for inhalation, besides oxygen gas, other gases were also inhaled. He is the chief representative of an opinion which gradually became universal, that in inflammatory conditions of the lungs, and especially in pulmonary phthisis, the use of oxygen gas must be avoided. Beddoes therefore inaugurated an opposite course of treatment, by making his

patients inhale air which by a mixture of nitrogen and hydrogen was diluted so as to contain less oxygen than atmospheric air. Even carbonic acid was used by him for inhalations, and an anodyne and antiseptic influence was attributed to it. Finally he introduced the plan of residing in cow-houses during various stages of phthisis, and by his prestige and his writings he exercised considerable influence in the general spread of the inhalatory method at the end of the last and beginning of the present century.

The *physical* properties of the air were also taken more and more into consideration during that period, and in 1783 the Haarlem Academy of Sciences offered a prize to anyone who should (1) construct and describe an apparatus adapted for experiments with condensed air, and (2) with the help of this apparatus would make experiments upon the influence of condensed air on the life of animals and plants and upon the burning of different kinds of gases.

It was not till fifty years afterwards that claims were put forward for this invitation of the Academy, after observations had already been made by the Russian physician Hamel (1820) and the English physician Colladon (1826) by means of the diving-bell on the effect and the value of condensed air for curative purposes.

If the magnificent discoveries of chemistry in the last century had misled physicians into exaggerated hopes as to the inhalations of these new aeriform bodies, and induced them to try them in all kinds of diseases; now that the result proved so out of proportion to the expense of the curative apparatus and the sanguine expectation which had been raised, a violent reaction followed, which was carried just as far in the other direction without any attempt at critical appreciation, and the whole system of respiratory therapeutics was again left to lie fallow.

#### *Fourth Period.*

As usually happens in all scientific developments, after so strong a retrograde movement, fresh and powerful excitements were needed to overcome the discouragement which had been produced, so as to advance again with due method and with proper appreciation of the data which had already been gained.

It was not till the second decade of the present century, when Davy had proved the disinfecting and antiseptic action of chlorine gas, when iodine had been discovered in the mother lye of marine plants by Courtois in 1811, and the action of tar vapour in diminishing expectoration had been recognised by Alexander Crichton, Hufeland, and others, that physicians again began to think seriously of trying these new methods for arresting the same morbid processes in which they had formerly been tried in vain.

Tuberculosis was again the malady upon which Bourgeois, Coutereau, and in Germany Pagenstecher, Albers, and others tried the effect of chlorine gas, till it was shown by Toulmouche that chlorine inhalations were of no avail in this disease, while on the other hand Piorry, Laennec, Berton, Murrey, Scudamore, and more recently Huette tried iodine in various forms, sometimes by inhalation of vapours obtained from seaweed, sometimes by the inhalation of the vapours of ethereal solutions of iodine; but here again uncertainty in diagnosis necessarily led to apparently contradictory results, and alternately aroused and depressed expectation.

It was in accordance with the spirit of the time that, notwithstanding the negative results which followed these attempts, new experiments were constantly undertaken and new methods tried, in striving to obtain, in one way or another, some therapeutic advantages. With the rapid advance of the exact sciences medicine also had undergone a complete transformation, which necessarily demanded a reorganisation of its therapeutic branch.

So Crichton employed the vapours of oil of turpentine with advantage in phthisis, Skoda in pulmonary gangrene, Stokes, Niemeyer, and others in chronic bronchitis. For the same disease Lassègue and Gieseler recommended inhalation of vapours of sal ammoniac, while the French physicians, especially Pujade at Amélie-les-Bains, advised inhalation of the sulphur vapours given off by the mineral springs there. Observation of the rapid narcotic effect of opium-smoking subsequently suggested the idea of employing such readily volatilised narcotic drugs as are easily absorbed by the bronchial mucous membrane and the lungs, like datura stramonium

(Ziegler, Trousseau) and belladonna, in the same way as in tobacco-smoking. Lastly, air impregnated with particles of salt, as in the evaporation works and the so-called saline spray baths at Reichenhall, Kissingen, Kreuznach, Ischl, Kösen, Meinberg, &c., have been largely used by the physicians of those spas as curative inhalations in a variety of pulmonary affections.

So again the idea which had been started in the previous century of turning to therapeutic account the mechanical effect of changes in atmospheric pressure upon the animal body, was now at length carried into effect with the aid of improved mechanical contrivances, and with a better knowledge of the physiology and pathology of the respiratory organs.

The invitation of the Haarlem Academy in 1783, which we have mentioned, was responded to about fifty years ago by the labours of three Frenchmen, two physicians, Junod and Pravaz, and a physicist, Tabarié, each of whom received a prize. Whereas the scheme for the employment of condensed air in medicine, first presented to the Academy and entrusted to the physiologist Majendie to report upon, yielded no results of any value, the methods of Tabarié and Pravaz, sent in afterwards, satisfactorily established the therapeutic influence of alternate condensation and rarefaction of the air, either applied locally to separate limbs or generally over the whole body. Tabarié, who on December 7, 1832, laid his communications before the Académie des Sciences, recommended the employment of condensed air in different diseases of the respiratory organs, and quoted forty-nine cases, some cured, some alleviated; in the year 1840 he founded the first pneumatic institution at Montpellier, while Pravaz combined his orthopædic institution at Lyons with a pneumatic one.

After Tabarié there followed a long series of publications on the subject of the action and application of compressed air, and in a short time there were founded the institutions of Dr. Pol, of Dubreuil at Marseilles (1847), of Dr. Millais at Lyons (1848), of Dr. E. Bertin (1850), of Felix Hoppe (1855), and others at Altona, Hamburg, Nice, Johannisberg, Copenhagen, Petersburg, Ems, Reichenhall, &c. From the observations made and the successful results recorded in these different curative institu-

tions, the indications were gradually established for the employment of condensed air in catarrhs of the respiratory organs, in emphysema, in chronic pneumonia, as well as in a series of diseases of other organs and general ailments—anæmia, obesity, uterine maladies, &c.—in which the good results were referred partly to the pressure of the condensed air, partly to increase in the relative proportion of oxygen in it.

#### *Fifth Period.*

All the medicaments used for inhalation up to the beginning of this century were only such bodies as were readily vaporisable, or, being gaseous, could pass without difficulty through the air passages into the lungs. But now, by means of mechanical contrivances for the reduction of fluids into the finest spray, we have succeeded in applying substances in solution in water directly to the air passages in the form of inhalation.

A series of preliminary experiments with this object in view had already been made. Thus the physicians at various spas, as already mentioned, had introduced the inhalation of air impregnated with saline particles in the evaporation works, and the saline spray baths of the thermal salt springs; and in January 1829 Schneider and Rudolf Walz had constructed their 'hydroconion,' which consisted of a reservoir containing water, the upper half of which was occupied by air compressed by means of an air pump, and the fluid was thus driven out through more or less narrow apertures. The apparatus itself was not used for inhalations, but for spray baths. On the other hand, Hirzel at Zürich in 1829 made phthisical patients inhale a marine atmosphere by causing sea water to be injected through fountains into a small room. The first direct attempt to convert liquids into spray was made in the year 1849 by Auphan at Euzet-les-Bains, who caused a jet of the local spring to be projected against the wall of a room; shortly afterwards a similar institution was set up at Lamotte-les-Bains, where a column of water seven mètres high was forcibly projected against a wall, and so filled the room with a mass of tolerably fine spray.

But the idea so often canvassed first received practical application and form from Sales-Girons, who, in conjunction with



Fluré, not only erected a hall for inhalation at Pierrefonds, in which the process of converting the local mineral water into spray left nothing to be desired, but also devised a movable apparatus for reducing to spray other medicinal fluids, and demonstrated it before the Academy of Sciences in the year 1858. Sales-Girons gave the new method the distinctive but not quite appropriate name *pulvérisation des liquides médicamenteux*, and the very ingenious apparatus constructed by Charrière was called by him *pulvérisateur portatif des liquides médicamenteux*. By this discovery of Sales-Girons it became possible to bring into direct contact with the mucous membrane of the respiratory organs and with the lungs themselves almost all the pharmacological media whose topical action had been thoroughly tested both in medical and surgical practice, for they are almost all of them soluble in water, and can therefore be reduced to fluid 'dust' by the pulvérisateur, and so inhaled. This invaluable discovery did not, however, meet with universal acceptance, for there arose, in strong opposition to a party of enthusiastic adherents which was soon formed in France and in the rest of Europe, another party who denied that the particles of spray really penetrated into the deeper part of the respiratory passages, and who maintained that before the fine particles could reach these parts they were condensed into larger drops and ran down the walls of the upper part of the respiratory tract. The question of the penetration of the pulverised fluid into the organs of respiration soon became a subject of lively discussion, treated on both sides with great acumen, and supported by numerous experiments on human beings and animals, and on account of its great interest it was repeatedly brought before the meetings of the French Academy. In France itself the most lively contest was excited. Pietra-Santa, Poggiale, Briau, Fournié, and others sought to bring forth evidence, partly by experiments on animals—rabbits, dogs, horses, goats, &c.—partly by direct experiments on human beings, in testing the chemical reaction of the sputa, and by laryngoscopic examinations after the inhalation of coloured fluids, solutions of indigo, &c., that the 'powdered liquids' of Sales-Girons' apparatus did not penetrate deeply into the air passages, while Sales-Girons, Demarquay, Moura-Bourouillou,

Tavernier, Durand-Fardel, Trousseau, Gratiolet, Bataille, and others set their positive results over against those negative ones, and at the same time exposed the errors in the experiments and observations of their opponents. At the same time in Germany, Russia, &c., the question was discussed in the same way, and the whole of medical literature, periodicals and manuals, immediately after the Sales-Girons' discovery took it up eagerly and collected a mass of evidence on both sides. The question has now been decided in the affirmative, as it was before the French Academy, and we may therefore treat this subject, so important from the point of view of respiratory therapeutics, simply historically, without entering into an examination of the evidence for and against it. Together with the scientific and therapeutic side, the technical application of the new method reached greater and greater perfection in France, Germany, and Russia (Sales-Girons, Demarquay, Moura, Trousseau, then Lewin, Waldenburg, Siegle, Fieber, Zdekauer, and others), and a great number of highly appropriate and cheap apparatuses have been constructed for individual use, in which Siegle's idea of pulverising the medicinal fluid by means of steam has ultimately proved most generally acceptable.

Side by side with these advances in the administration of chemical and pharmaceutical remedies, the application of compressed air in the pneumatic chamber was also subjected to the most stringent examination. In the year 1868 appeared the exhaustive work of V. Vivenot on 'The Physiological Action and the Therapeutic Value of Condensed Air,' which placed on a physiological basis the previous empirical observations, while at the same time he employed increased air pressure in the treatment of his own chest affection with favourable results. Subsequently a long series of works appeared by Panum, Sandahl, G. v. Liebig, Simonoff, and numerous others, making suggestions as to the action of compressed air, or for the improvement of the apparatus in the way of form, ventilation, and heating (G. v. Liebig), and thus contributing more and more to further the introduction into practice of the employment of compressed air in the pneumatic chamber.

The most fruitful idea in connexion with the physico-mechanical treatment of diseases of the respiratory organs,

which may be placed side by side with Sales-Girons' discovery, is due to J. Hauke, of Vienna, who tried to bring both condensed and rarefied air to bear locally on the lungs, and for this purpose constructed a portable apparatus, by which the patient could inspire compressed air and expire into rarefied air. Although the apparatus invented by Hauke was somewhat imperfect, yet the rational basis of the method led at once to the recognition of its value and encouraged others to further attempts and improvements. Next appeared, by Dr. Mader, the first theoretical examination into the favourable effect of expiration into rarefied air in emphysema. After this various works appeared by Dr. Rohden and by the English physicians J. W. Berkart and H. Dobell; Hauke himself preferred the inhalations of compressed air in cases of croup, in cases of the phthisical habit, of feeble chest, and in apex catarrh. But we are indebted to Waldenburg for perfecting this method and for the introduction of many technical improvements. The apparatus which Hauke devised was defective in the limited amount of pressure, both in degree and duration, it was capable of maintaining. Waldenburg remedied these defects by the construction of a new and portable apparatus, and by his researches into the mechanical action of this apparatus upon respiration and circulation he secured a firmer basis for its application. The double apparatus of Cube is on the model of Waldenburg's; it admits of the alternate use of compressed and rarefied air, as do a series of apparatus devised by Schnitzler, Tobold, Weil, and others. The apparatus more recently introduced by Biedert, B. Fränkel, Störk, G. Lange, and Geigel are founded upon other principles, to which we shall again revert. At the same time accounts of a series of experiments upon the action of these apparatus upon the functions of respiration and circulation were published by J. Schnitzler, Dührsen, K. Störk, J. Sommerbrodt, and others. In 1874 Hœnisch by means of the stethograph and sphygmograph proved the therapeutic effect of compressed and rarefied air on the organs of respiration and circulation. In 1875 Drosdoff and Botschetschkaroff as well as Dueroq, made kymographic, and Riegel, Frank, and Sommerbrodt (1875, 1876) made sphygmographic experiments upon the physiological action of compressed air upon the arterial blood pressure

of animals, as compared with that of human beings, while in 1875 Domanski introduced the combined application of volatile medicaments with inhalations of compressed air, and Cube and Biedert published a series of communications with regard to the application of compressed and rarefied air to the lungs.

Respiratory therapeutics have made very remarkable progress during the last twenty years, compared with former periods. Not only have we completely realised, by improved technical appliances, the original conceptions to which the different kinds of apparatus were intended to give effect, but the simultaneous advances in physiology and pathology, as well as in diagnosis and pharmacology, have certainly altered the character of our therapeutic aims. We have learned to know better what is attainable, and whereas the system of former times was to make a radical attack upon the complicated processes of disease, now by accurately measuring the means within our reach and the nature of the pathological disturbances, and by careful observation of the symptoms, we have acquired more definite principles and a broader basis for the local application of chemical and physical remedies. We have also during recent years made great advances in the etiology of the different processes of disease, and obtained such insight into them as we could hardly have anticipated, and there is no reason to doubt, though this may still lie in the distant future, that we shall at last hold the means in our hands of actually removing the causes which lie at the root of these fatal diseases, and after annihilating their infectious character be able to deal successfully with the processes thus simplified. Already pathological experiment has in many directions given us insight into the nature and development of pathological processes, and we may believe that therapeutics also will, by means of experiment, establish indisputable truth, and passing out of the domain of empiricism, become established on a strictly scientific basis.

But as yet we are only standing on the threshold, and seem still remote from such results; but by the very fact that we now know *how* we must work we have already enlisted ourselves on the side of exact research, and have made her method ours.

I.  
THE CHEMICAL PART  
OF  
RESPIRATORY THERAPEUTICS.

---

INHALATIONS.

THE TREATMENT OF DISEASES OF THE RESPIRATORY  
ORGANS BY THE INHALATION OF CHEMICAL AND  
PHARMACOLOGICAL REMEDIES.

---

BIBLIOGRAPHY.

*Hippocratis Opera*, translated by Fabius Calvus, 1515. 'De Morbis,' liber secundus, p. 286.—*Celsi Medicinæ libri octo*, ex recensione Leonardi Targae. Verona, 1810. Liber tert. et quartus.—*Caii Plinii Secundi Historia naturalis*. Ex recensione Harduini. Deux-Ponts, 1783.—*Aretæi Cappadocis Opera*. Edit. cur. Kühn. 'De Curatione Morbor. diurn.' lib. i. cap. viii. De Curatione Phthiæos. Leipzig, 1828, p. 323.—*Galenî Opera*. 'De Methodo med.' lib. iv.—Bennet: *Vestibulum ad Theatrum Tabidorum*, 1654.—Ramazzini: *De Morbis Artificum diatribe*. Utrecht, 1703.—Priestley: *Experiments and Observations of Different Kinds of Air*. London, 1774.—Beddoes and Watt: *Considerations on the Medical Uses and on the Production of the Factious Air*. London, 1796.—Beddoes: *On the Latest Methods of Curing Phthisis, and on the Cowhouse Cure*.—*Hufeland's Journal of Practical Medicine*, 1796, vol. i. part iii. p. 374: 'On the Use of Artificial Kinds of Air by Inspiration in Diseases of the Chest.'—Günther: *Results of Pneumatic Chemistry for Practical Medicine*. Marburg, 1801.—*Hufeland's Journal*, 1809, vol. xxviii. part v. p. 88, 'System of Treatment pursued by Hufeland in the form of Inhalation.'—'Report of the Experiments made by the House Physicians Hufeland and Neumann in the Charité on the Influence of Tar Vapours in Phthisis pulmonaris,' *Hufeland's Journal*, 1820, vol. i. part i. p. 90.—*Hufeland's Journal*, 1822, vol. lv. part ii. p. 85, 'Experiments upon the Employment of Narcotic Drugs in the form of Vapour.'—Alex. Crichton: *Practical Observations on the Treatment and Cure of several varieties of Pulmonary Consumption, and on the Effects of the Vapour of Boiling Tar in that Disease*. London, 1823.—Erdmann: *Hufeland's and Asann's Journal of Practical Medicine*, 1831, vol. vi., December, p. 3.—Loewe, l.c. vol. lxxxvii. part vi. p. 16.—Petrenz, l.c. vol. xcvi. p. 4.—

Laennec: *Diseases of the Lungs and Heart*, translated by Meissner. Leipzig, 1832.—Martin Solon: 'Considération sur l'Atmiatrie ou sur l'usage des Fumigations dans quelques Maladies, et particulièrement dans les Affections de l'Appareil Respiratoire,' *Gazette méd. de Paris*, 1834, No. 12, p. 177.—William Stokes: *Dissertations on the Diagnosis and Treatment of Chest Diseases*.—Lobethal: *Proof that Pulmonary Phthisis is Curable*. 1841.—A. B. Maddock: *Practical Observations on the Efficacy of Medicated Inhalations in the Treatment of Pulmonary Consumptions, Asthma, Bronchitis, Chronic Cough, and other diseases of the Respiratory Organs, and in Affections of the heart*. London, 1845.—J. Hirzel: 'On Artificial Sea Air as a Remedy for Tubercular Pulmonary and Bronchial Phthisis,' *Schweizer Canton-Zeitschr.*, Nos. 1, 4, 1845; *Schmidt's Jahrbücher*, 1846, li. pp. 2, 84.—*New Method of Treatment of Inflammation of the Lungs and other Chest Diseases, with a Description of the Abortive Method*, by S. Baumgärtner, with contributions from Helbing, Von Rotteck, Schmidt, V. Wänker, Weber, Werner, and Wucherer. Stuttgart, 1850.—Varrentrapp, *Henle und Pfeuffer's Zeitschrift für ration. Med.* i. 1, 1851.—*On the Direct Application of Pure Iodine in treating Pulmonary Phthisis*, by Prof. Chartroule. Paris, 1851.—Brockmann: *The Metallurgic Diseases of the Upper Hartz*. Osterode, 1851.—Merkel: 'The Latest Results in the Treatment of Asthma,' *Schmidt's Jahrbücher*, 1861, cix. p. 243.—Sales-Girons: *Thérapeutique respiratoire, Salles de Respiration nouvelles, &c.* Paris, V. Masson, 1858.—*Id.*: *Traité théorique et pratique des Salles de Respiration nouvelles, &c.* V. Masson, 1858.—*Traitément de la Phthisie pulmonaire par l'inhalation des liquides pulvérisés et par les fumigations de gourdou*. Paris, 1860, Savy.—*Id.*: 'De la Diète de la Respiration dans le Traitement des Maladies de Poitrine,' &c., *Mémoire, Acad. de Méd. de Paris*, Jan. 2, 1861.—*Id.*: *Instruction sur l'Instrument pulvérisateur, &c.* Paris, chez Charrière, 1861.—Prosper de Pietra-Santa. *L'Union médicale*, 1861, Nos. 43, 44, 59.—*Gazette médicale de Paris*, 1861, Nos. 41, 42, 43.—Briau: *L'Union médicale*, 1861, 9 mai, No. 56.—Champouillon: *Gazette des Hôpitaux*, 1861, No. 66.—Delore: *Gazette médicale de Lyon*, sep. 1 et 16 1861.—Armand Rey: *L'Union médicale*, 1861, No. 139.—Moura-Bourouillou: 'De l'Inspiration et de la Pénétration des Liquides pulvérisés,' *Gaz. des Hôpitaux*, 1861, 24 oct., No. 125.—Auphan: 'De la Pulvérisation à Euzet-les-Bains et ses Effets thérapeutiques,' *Acad. de Méd.* 30 avril 1861.—*Gaz. méd. de Paris*, 18 mai 1861.—*Id.*: 'Nouvelles Expériences pour servir à la solution de cette question: L'eau pulvérisée pénètre-t-elle dans les bronches?' *Académie de Méd.*, séance du 29 oct. 1861.—Sales-Girons: 'Sur la Théorie physiologique de la Pénétration des Poussières dans les Voies respiratoires,' *L'Union méd.* 1861, 6 déc.—Zdekauer: 'On the Treatment of Hæmoptysis,' *Wiener med. Wochenschrift*, Nos. 30 and 31, 1861.—Fournié: *De la Pénétration des Corps pulvérisés gazeux, solides et liquides dans les Voies respiratoires*. Paris, Adrien Delahaye, 1862.—Durand-Fardel: *Séance of the Paris Academy of Medicine* on Jan. 7, 1862. Trousseau: *Séance of the Paris Academy of Medicine*, May 6, 1862.—Demarquay: 'Mémoire sur la Pénétration des Liquides pulvérisés dans les Voies respiratoires et de leur application au Traitement des Maladies des Yeux, du Pharynx et du Larynx,' *Bulletin de l'Acad. ; Gaz. Méd. de Paris*, 1862, Nos.

25 and 26.—Lingen: 'Inhalations of Chloride of Iron in Hæmoptysis,' *Petersburg Med. Journal*, 1862, No. 17, p. 137.—Wistinghausen: 'Communications on the Use of Inhalations in various Diseases of the Respiratory Organs,' *Petersburg Med. Journal*, 1862, No. 17, p. 129.—F. Fieber: 'On the Inhalation of Medicated Fluids in a Pulverised Form,' *Wochenblatt der Gesellschaft der Aerzte in Wien*, Nos. 1 and 2, 1862.—Id.: 'Contributions to the Theory of the Inhalation of Pulverised Fluids,' *Oesterrech. Zeitschr. f. prakt. Heilkunde*, No. 11, 1862.—Id.: *Allgem. Wiener med. Zeitschr.*, April 1862, No. 17.—Id.: l.c. May, 1862, No. 21.—Id.: *Allgem. med. Centrals.*, No. 51, 1862.—Id.: *Wiener Med.-Halle*, Aug. 1862, No. 33.—Id.: *Revue méd.*, July 15, 1862.—R. Wedemann: *Inhalation of Medicated Fluids*, a Contribution to the Local Therapeutics of Respiratory Diseases. Jena, 1862, Fromann.—Tobold: *Deutsche Klinik*, No. 22, 1862.—Lewin: Communications, &c., *Allgem. med. Centrals.*, 16 Nos., from Aug. 6 to Dec. 31, 1862.—Waldenburg: *Deutsche Klinik*, Nos. 44, 45, 46, 1862.—Schnitzler, *Wiener Med.-Halle*, 1862, No. 29, July.—Id.: *Wiener Med.-Halle*, 1862, No. 48.—Villaret: *Case rare d'Anthraxosis*. Paris, 1862.—Dr. J. Bergson: 'Description of Modern Apparatus for Inhaling,' *Deutsche Klinik*, No. 7, 1863.—Fournier: *Étude pratique sur le Laryngoscope et sur l'application des Remèdes topiques dans les voies respiratoires*. Paris, Adrien Delahaye, 1863.—H. Vogler: *The Diagnosis and Treatment of Chronic Laryngitis*. Berlin, G. Reimer, 1863.—Arnus (Puda de Montserrat in Spain): *La Revue médicale*, &c., 31 mars 1863.—G. v. Liebig: *Reichenhall, its Climate and its Resources*. Munich, E. Stahl, 1864, p. 7.—Biermer, *Schweizer Zeitschrift für Heilkunde*, vol. iii. pp. 157 and 352, 1864.—Küchenmeister in his *Zeitschrift für med. Chir. u. Geburtshilfe*, vol. iii. p. 233, 1864.—Foerster: 'On Solvent Remedies in Diphtheritic and Croupous False Membranes,' *Archiv für Heilkunde*, 6, p. 521, 1864.—Schuchardt in his *Zeitschrift f. prakt. Heilkunde*, 1864, No. 6, p. 631.—Michel in Küchenmeister's *Zeitschrift für med. Chir. und Geburtsh.*, No. 5, 1864.—Wietfeld: *Allgem. med. Centrals.*, 25, 1864.—Lobethal: *Medical Adviser for Pulmonary Patients*, &c. Berlin, 1864.—Wenz, *Württemberg. Correspondenz-Blatt.*, Dec. 15, 1864.—Dr. J. Baumgärtner: *Affections of the Larynx and their Treatment, together with New Inhalatory Apparatus and Instructions for Laryngoscopic Examination*. Freiburg im Breisgau, 1864, F. Wagner.—Waldenburg: *Inhalations of Pulverised Fluids, also of Vapours and Gases*, &c. Berlin, 1864, G. Reimer.—Dr. E. Siegle: *Treatment and Cure of Affections of the Throat and Lungs by Inhalations*, &c., 2nd edition. Stuttgart, 1865, A. Kroener.—Brauser: 'Treatment of Croup,' *Münchener ärztl. Intelligenzbl.*, 10, 1865.—Lewin: *Clinic on Diseases of the Larynx*, vol. i., Inhalatory Treatment, &c. Berlin, 1865, Hirschwald.—Morell Mackenzie: *Medical Times and Gazette*, 1865, No. 765.—Id.: *The Use of the Laryngoscope in Diseases of the Throat*. London, 1865.—Rosenthal: 'Researches and Observations on the Action of Pulverised Substances upon the Organism,' *Wiener med. Jahrb.*, vol. xi. 1866.—Traube: 'On the Penetration of Fine Particles of Coal into the Interior of the Respiratory Apparatus,' *Deutsche Klinik*, 1860, Nos. 49 and 50, 1866, No. 3.—Zenker: 'On the Diseases of the Lungs generated by inhaling Dust,' *Deutsches Archiv für klin. Medicin*, vol. ii. 1866.—Seltmann: 'Anthraxosis of the Lungs

among Miners,' l.c.—Kussmaul and Schmidt: 'Ashy Constituents of the Lungs,' l.c.—H. E. Schmid: *The Med. Record*, April 15, 1867.—Knauff: 'The Pigment of the Respiratory Organs,' *Virchow's Archiv*, vol. xxxix. 1867.—Slavjansky: 'Experimental Contributions to the Theory of Pneumococcosis,' l.c. vol. xlviii. 1869.—Leyden: *Berlin. klin. Wochenschr.*, No. 36, 1870.—Id.: *Association for Scientific Medicine at Knüppberg in Prussia*, séance of March 29, 1870.—Rothe: *Berliner klin. Wochenschr.*, Nos. 23, 24, 1870.—Hirt: *Diseases of Workmen*, section i. part 1, 'Diseases from inhaling Dust.' Breslau, 1871.—Waldenburg: *The Local Treatment of Diseases of the Respiratory Organs*, &c., 2nd edition of the former work, 'Inhalations,' &c. Berlin, 1872, Reimer.—Jochheim: *Mode of Action of Respirable Gases*. Erlangen, 1872, F. Enke.—Hirt: 'Diseases from Inhaling Gas, Diseases incident to Certain Occupations,' *Manual of Spec. Pathol. and Ther.*, published by H. v. Ziemssen, vol. i. 2nd. edit. 1875.—Merkel: 'Diseases caused by the Inhalation of Dust,' l.c.—M. J. Oertel: 'Epidemic Diphtheria,' l.c. vol. ii. 1876.—Von Ins: 'Experimental Investigations on the Inhalation of Gritty Dust,' *Archiv für experiment. Pathol. und Pharmakol.*, vol. v. No. 3, 1876.—Steinbrück: 'Cure of so-called Chronic Pulmonary Tuberculosis by Inhalations of Nitrogen Gas,' *Allgem. med. Centralz.*, part 32, 1876.—Böcker: 'On Inhalations after Tracheotomy,' *Hufeland's Association-Séance*, Nov. 26, 1875; *Allgem. med. Centralz.*, No. 48, 1876.—Brügelmann: 'On the Use of Oxygen Gas,' &c., *Allgem. med. Centralz.*, No. 41, 1877.—Jaeger: 'On Inhalation of Bromic Vapours in the Treatment of Croup,' *Corresp.-Blatt für Schweizer Aerzte*, No. 15, 1877.—Birch-Hirschfeld: 'On the Occurrence of Lower Organisms in the Sputa in Whooping Cough,' *Congress of German Scientific and Medical Men at Munich*, 1877.—Ruppert: 'Experimental Researches on Inhalation of Coal Dust,' *Virchow's Archiv*, vol. lxxii. No. 1, 1878.—P. Bert: 'La Pression barométrique,' *Recherches de Physiol. expériment.* Paris, Masson, 1878.—Hoppe-Seyler: *Physiologische Chemie*, parts 1 and 2, 1877 and 1878.—Fantini: 'Pulverised Lime Water in Pulmonary Phthisis,' *Nuovo Giornale internazionale delle Scienze medicine di Napoli*, No. 6, 1878.—Birch-Hirschfeld: 'Treatment of Whooping Cough with Inhalations of Carbolic Acid,' *Deutsch. Archiv f. klin. Med.*, vol. xxii. Nos. 5 and 6, 1878.—Moritz: 'Carbolic Spray in Catarrhs,' *St. Petersburg. med. Wochenschr.*, No. 1, 1879.—Treutler: *The Preparation and Application of his Nitrogen Inhalations in the Treatment of Pulmonary Diseases*. Dresden, 1879.—Avena: 'Prolonged Anæsthesia under Laughing Gas,' *Gaz. hebdom. de Méd. et de Chir.*, No. 14, 1879; *Wiener med. Wochenschrift*, No. 10, 1879.—Mosler: 'On the Inhalation of Oleum Eucalypti in Pharyngeal Diphtheria,' *Berliner klin. Wochenschrift*, No. 21, 1879.—E. Thorner: 'Treatment of Whooping Cough by Inhalations of Carbolic Acid,' *Deutsches Archiv für klin. Med.*, vol. xxii. p. 314, 1879.—Vix: 'Inhalation of Benzoic Acid,' *Memorabilia*, No. 12, 1879.—Schüller: 'On Therapeutic Experiments on Animals Infected with Tuberculosis and Scrofulous Septic Substances,' *Archiv für experim. Pathol. u. Pharmakol.*, vol. xi. Nos. 1 and 2, 1879.—Rokitansky: 'Treatment of Phthisis by Benzoate of Soda in Inhalations,' *Wiener med. Presse*, No. 42, 1879.—Schnitzler:



‘Critical Remarks on the Therapeutic Value of Inhalations of Benzoate of Soda in Pulmonary Phthisis,’ *Wiener med. Presse*, No. 42, 1879; *Pester med.-chir. Presse*, No. 43, 1879.—Körner: ‘On the Inhalation of Bromide of Potassium in Tussis convulsiva,’ *Berliner klin. Wochenschr.*, No. 46, 1879.—P. Gutmann: ‘On Inhalation of Benzoate of Soda in Pulmonary Phthisis,’ *Berlin. klin. Wochenschr.*, No. 49, 1879.—Wenzel: ‘On the Use and Action of Benzoate of Soda in Phthisis,’ *Berliner klin. Wochenschr.*, No. 49, 1879.—H. Curschmann: ‘Local Treatment of Putrid Bronchial and Pulmonary Affections,’ l.c. vol. xvi. Nos. 29 and 30, 1879.—Kohlschütter: ‘Inhalations of Nitrogen Gas and its Effect,’ *Corresp.-Blatt. des Vereins der Aerzte im Reg.-Bez. Merseburg und des Herzogthums Anhalt*, 1880.—R. Hausmann: ‘Treatment with the Inhalation Respirator,’ *Berliner klin. Wochenschr.*, vol. xvii. No. 34, 1880.—Feldbausch: ‘On a New Method of Permanent Inhalation,’ l.c. vol. xvii. No. 47, 1880.—P. Niemeyer: ‘Medical Discussions’ (*Aerztl. Sprechungen*), No. 28 (vol. vi. No. 3).—W. Brügelmann: ‘Inhalatory Treatment in Diseases of the Throat, Chest, Nose,’ &c. Cologne and Leipzig, E. H. Mayer, 1880.—J. Gottstein: ‘On the Value of the Inhalation of Medicated Substances,’ *Breslauer ärztl. Zeitschr.*, No. 8, 1881.—O. Piner: ‘Diphtheritis and Tracheotomy’ (from the Clinique of Prof. Maas at Freiburg im Breisgau), *Deutsche Zeitschr. f. Chir.*, vol. xiv. p. 288, 1881.—M. J. Oertel: ‘On the Treatment of Pharyngeal Diphtheria,’ *Archives of Laryngology*, vol. ii. No. 1, Jan. 1881. New York.

---

#### ANATOMICAL DISPOSITION OF PARTS IN RELATION TO THE INHALATION OF MEDICINAL SUBSTANCES.

THE great difficulty to be overcome in attempting to treat locally diseases of the respiratory organs consists in applying the medicinal substances to the parts affected. And whereas the method peculiar to this form of treatment closely resembles the methods of surgical procedure, it yet differs from them in essential points, although the criticisms which have been directed against it have always rested chiefly on this resemblance.

One objection to this method, therefore, has been that the remedies employed are not applied directly to the parts affected by the skilful hand of the operator, but have to be conveyed by the respiratory current to their destination, which it seems possible they may never reach; while they must come into contact with both healthy and diseased structures, which are therefore alike submitted to their chemical action.

Another objection has been that, owing to the peculiar anatomical structure of the air passages, the air inspired is as

it were filtered, so that in ordinary breathing the entrance of all foreign particles with the air is prevented, and the air thus becomes purified before it can penetrate into the deeper air passages, which by their ramifications are constantly becoming smaller and smaller. The anatomical structures herein concerned consist of irregular hollow spaces and winding canals, connected with one another at different angles, generally at right angles, and separated from one another by more or less projecting septa; and, if it be true that particles of dust mingled with the air can only pass easily through tubes and hollow spaces when they run in a straight course, and that, when this is not the case, they generally strike against the adjacent walls, and if these are moistened with water or an adhesive fluid they adhere to them, it follows that only when tubes meet at very obtuse angles will a portion of the fine dust be carried deeper by the inspiratory current.

If we subject the respiratory passages to a minute examination, we shall find that the cavity of the nose is divided by the turbinated bones into a system of winding, irregular passages, and the oral cavity is susceptible of a variety of changes of form through the movements of the tongue and the soft palate; both cavities are continuous at a right angle with the pharyngeal and laryngeal cavities, into which again the epiglottis projects as a more or less incomplete septum, while at the base of the epiglottis the vocal cords narrow the entrance into the trachea and can close it. Under normal conditions, in quiet breathing, the air either enters through the nares alone, and the oral cavity remains entirely closed, or the mouth is at the same time more or less opened, the dorsum linguæ is somewhat elevated, and the velum palati hangs down and touches the dorsum linguæ; thus a wide, shallow, serpentine canal is formed, in which the posterior pharyngeal wall remains completely invisible. At the same time the epiglottis lies close on the orifice of the larynx, and the vocal cords form movable barriers at the entrance of the air tubes. Under such circumstances most corporate substances, and therefore minute solid or liquid particles, become deposited on the adjacent surfaces of these parts, while only those bodies which resemble in their condition the air with which they are inseparably

blended pass along together through this, as it were, filtering apparatus and reach the ultimate divisions of the air passages.

But should the entrance even of such bodies exert an irritant effect on the walls of the air passages with which they come in contact, there exist means of a protective nature, either simply physico-mechanical or chemical. This consists in the sensitiveness of the mucous membrane lining the air passages, so that if the inspired air exerts upon it an abnormal and unaccustomed exciting influence, it is at once reflexly driven back, and, by contraction of the air tubes, its further ingress is arrested. Such an exciting influence may be of a physico-mechanical nature, such as the mere quantity of the substances forcing their way in with the inspired air, or the force and manner of introduction, or their temperature, and like circumstances. In other cases the irritating action is due to the specific chemical properties of these substances acting on the sensitive mucous membrane of the glottis and upper part of the respiratory tract, and this chemical action becomes all the more felt if the accompanying physical conditions are also more or less irritating. By this anatomico-physiological arrangement, therefore, an elimination of the bodies mixed up with the inspired air will take place in a strictly definite manner dependent on their physical state. Those in the solid form are simply filtered, and remain adherent to the mucous surface without any effort at their speedy discharge, so that they can penetrate into the air passages of the respiratory organs until they encounter some mechanical impediment to their further advance. This will also be the case with the particles of pulverised fluids, only that they, when they pass with the current of air through narrow canals and fissures, tend to approximate, and coming into contact flow together into larger drops, which become deposited, and have therefore greater difficulty than solid particles in passing through these narrow tubes. Aeriform bodies or gases encounter none of these mechanical hindrances, and they make their way through the various air passages even to their terminal ramifications. On the other hand, the entrance of all these bodies is at once resisted and a stop put to their further inspiration if they act as irritants, no matter whether they are in the form of solids,

fluids, or gases. It is possible to breathe quite calmly in an atmosphere which is impregnated with coal dust or with particles of water in fine subdivision, and an irrespirable gas may even make its way unhindered into the glottis, if it is only mixed with the inspired air in small quantities, whereas ordinary atmospheric air, if it is inspired under too high pressure, or is too hot or too cold, instantly excites coughing and closure of the glottis.

The anatomical conditions which interfere with the entrance of pulverised solids and fluids into the respiratory organs can, however, be overcome if the apertures for admitting air are sufficiently widened, and the constricting organs<sup>1</sup> be withdrawn into their several recesses,<sup>2</sup> and if the communicating passages join each other so as to form a but slightly curved channel which narrows as it descends and divides (fig. 1). The oral and pharyngeal cavity thus comes to form a kind of funnel, whose axis is partly straight, partly a slightly curved line, and whose terminal aperture is formed by the glottis. In inspiration the air, impregnated with fine particles, completely fills up the cavity of the funnel, and in consequence of the aspiratory force the motile particles are drawn in directly through the glottis into the air passages and the bronchi, and in this process the greater number of particles are deposited on the upper part of the funnel-shaped tube in proportion to its diameter, while smaller numbers adhere to the walls of the continuously ramifying air passages, till only the lightest particles floating in the centre of the stream penetrate into its remotest branches and their terminations. These alterations of the relations of the several parts of the respiratory canal towards each other may be promoted unconsciously by wide opening of the mouth, by deep inspirations, and by all movements which widen the approach to the respiratory organs—e.g. by singing, speaking, yawning, &c.—but they are generally produced by direct conscious and intentional changes of the position of the different parts—e.g. by wide opening of the mouth, by holding the head raised, so that the right angle which the oral and pharyngeal cavity makes with the tube formed by the union of the larynx and the trachea is converted into an obtuse

<sup>1</sup> *i.e.* the vocal cords and the pillars of the fauces.—Tr.

<sup>2</sup> In the pharynx and larynx.—Tr.

angle, and by deep inspirations the greatest possible expansion of the glottis is produced by causing the vocal cords to lie completely back against the laryngeal walls. Simple and clear as these facts and conditions seem to be, yet it has required the most searching examinations and experiments, carried out with the



FIG. 1.

aid of all our technical appliances and all the acumen of an exact demonstration to establish their certainty. Only a few years ago the impossibility of the penetration of any amount of fine solid or fluid particles into the respiratory organs was

maintained in the most positive manner, and the most singular hypotheses were adopted rather than admit the probability of this simple physical process.

Lastly, the inspiration of substances in any form is also influenced by the individual sensitiveness of the respiratory organs, which differs so much in different persons that an irritation which in one person instantly excites reflex symptoms will not even be felt by another. But even in such cases habit is of much importance in enabling people to overcome a sense of irritation which may at first have appeared unendurable, and in causing them after a time to be actually unconscious of it. Thus prolonged residence enables us to endure atmospheric conditions in which the unaccustomed can scarcely breathe for a moment. In such atmospheres the cough excited by inspiration not only shows that the air really penetrates to the glottis, but also that it has the power of irritating it. On the other hand, the fact of the absence of cough in the case of persons accustomed to such atmospheres is no sign that the air does not penetrate into their respiratory organs, but only proves that it no longer exerts any irritating influence on them. We must judge in the same manner of the symptoms excited by the inhalations of artificial atmospheres, in which a particular medication is mixed with the inspired air in such a form that it can be inhaled. Habit will in this case also soon enable the patient to overcome the initial irritation, and the individual or diseased sensitiveness to the application of the appropriate topical remedies, if they are administered in suitable form and concentration for inhalation, will offer no impediment which careful treatment may not obviate.

The method of bringing medicinal substances in any form whatever into contact with the mucous membrane of the respiratory organs by blending them with the inspired air, is in the conditions specially prevailing here closely allied to surgical treatment, and is not less exact than the direct application of the remedy by the hand of the physician. But the strength of the medicinal agent and its degree of concentration present an essential difference in the two kinds of treatment, for in the one case the action of the agent can be strictly limited to the affected spot, but in the case of inhalations, even though it

may be usually required to influence wide tracts of tissue, yet it necessarily comes into contact with parts which, if they are not to suffer any injury, ought to remain exempted from its action.

These circumstances, however, which are inseparable from the method, simply necessitate a modification of procedure, and necessarily exclude the employment of caustics and similarly acting remedies ; these, however, can generally be replaced by other remedies, without essentially detracting from the value of the method and its sphere of action ; moreover, the mode of application of the remedy to the affected part necessitated by this method, as it avoids irritating influences, offers precisely those advantages which could not be attained by any other mode of treatment.

## ON THE PENETRATION OF FOREIGN BODIES INTO THE AIR PASSAGES.

### A. SOLID BODIES.

When a scientific basis was given to the method of administering pulverised fluids by inhalation, and efforts were made to introduce it into practice, the fundamental question whether foreign bodies in a solid or fluid form could penetrate into the air passages became the subject of much polemical discussion, and a mass of evidence was accumulated, consisting of pathological and anatomical researches, as well as the records of experiments on men and animals, the detailed account of which, as found in the manuals which appeared at the time, need not be repeated here, as the question has long since been decided in the affirmative and no longer admits of discussion ; still the material thus collected contains so much that is scientifically valuable, and affords details of so many physiological and pathological processes which are specially interesting here, that we shall make use of it, so far as it answers our purpose.

Naturally the question never was disputed as to the penetration of vapours and gases, which are in the same physical condition as the atmospheric air, and even with regard to minute solid particles it was scarcely doubted by the earlier authors that they really could make their way into the bronchi

and lungs, and it was not till modern times, especially since the introduction of the pigment theory, that it again became a matter of discussion whether the substances found in the lungs had made their way in from without or were the product of organic combinations in connection with pigment formation.

Even in ancient times no doubt whatever seems to have existed as to the possibility of the penetration of solid particles of dust into the lungs. According to Pliny, miners fastened bladders before their mouths, to prevent the inhalation of dust, and the Roman bakers, with the same view, tied a kind of cloth over their faces to protect them from the detrimental effect of the dust-charged atmosphere in which they worked.

Among the older physicians Ramazzini asserts definitely that a great proportion of the diseases of those engaged in dusty occupations proceeds from the dust which they inhale. As the lungs are constantly in motion, inhaling and exhaling air, and as their surface is covered with a slight moist secretion, the dust finds points enough to adhere to and upon which to exercise its deleterious influence. Many observations are also recorded in the literature of that time, to the effect that siliceous particles, sand or small stones, had been found in the lungs of workmen after death (Ramazzini and Diemerbröck), and that the knives used in dissecting such lungs grated and became blunted, as if they were cutting something sandy; and most medical authors who have made sufficiently accurate observations in their practice among colliers seem to have come to the conclusion that coal dust can penetrate into the lungs.

Thus Erdmann found that in the bodies of miners, when the thorax was laid open, the lungs sometimes appeared coal black, externally as well as internally, and stained white objects like ink; not unfrequently in such a lung dense concretions half an inch thick would be found. He assumes that the cause of the accumulation of pigment and the formation of stony masses in these lungs is the inhalation of coal and stone dust in the subterraneous works.

In a lecture delivered before the Hufeland Association on March 16, 1838, Dr. Löwe announced that in the autopsy of a subject who had been a collier for many years the mucous membrane of the trachea had been found loosened and covered



with little stony concretions and fine coal dust up to its bifurcation; the lungs were small, shrunk, and leathery, blue-black in colour, and as it were covered over with fine particles of coal and stony concretions of different sizes; also in the autopsy of a workman who succumbed to typhus fever at thirty-four years of age concretions the size of a pea were found scattered over the right lung.

Dr. L. Petrenz also found, in the post-mortem dissection of workmen who had been employed for a long time in sandstone quarries, various stony concretions in the walls of pulmonary cavities, some of which were as large as a small hazel nut; they were of a reddish grey colour and of irregular jagged shape, and soft on the surface like pumice stone; they were tolerably tenacious and could only with difficulty be crushed between the fingers.

Among the earlier observations on this subject the greatest general interest attaches to the experiments of Brockmann on the melanotic infiltration of the lungs of miners in the Hartz Mountains. Brockmann mentions as a characteristic mark of pneumomelanosia the occurrence of pigment granules, which, according to microscopical and chemical examination by the most able authorities of that time, were found to consist of a combination of vegetable and animal coal. These pigment granules, according to Brockmann, are found for the greater part not in the pulmonary vesicles and bronchi, but in the pulmonary parenchyma and in the walls of the obliterated bloodvessels. There they appear either free, like granular masses infiltrated into the parenchyma, or, more rarely, enclosed in oblong and circular cells of  $\frac{1}{150}$  of a line in diameter, which are sometimes completely filled with them. The granules themselves, which are found either singly or crowded together in dense masses, are generally not more than from  $\frac{1}{100}$  to  $\frac{1}{1000}$  of a line in diameter, and their shape is either round or irregularly angular; the pulmonary vesicles are described as (with few exceptions) retaining their normal texture.

According to the intensity of the infiltration of the lungs with these pigment granules, Brockmann distinguishes four degrees of melanosia, which are anatomically characterised as follows:—

1st degree. The deposits consist of separate spots, generally circular, rarely oval, still more rarely in the form of oblong stripes, often of a dark brown, and frequently of quite a black colour. These spots, of from 1''' to 2''' in diameter, are sometimes isolated, but generally in large masses crowded together, sometimes on the surface, sometimes in the centre of the otherwise healthy parenchyma.

2nd degree. Here sometimes extensive tracts of a melanotic tint are found, and a black fluid can be squeezed out of the pulmonary parenchyma.

3rd degree. In this stage of the disease these black patches are found in the periphery as well as in the central part of the lung; here and there between the melanotic mass appear parts of a lighter colour, in the form of ash-grey stripes several lines thick.

4th degree. Finally, in this advanced stage the whole pulmonary tissue appears uniformly infiltrated; the same black discoloration is found on superficial as well as deep incisions; everywhere the sections are pitch black, and everywhere a black fluid escapes from the cut surfaces. Also the walls of the bloodvessels, and even the more remote bronchial glands, have the same tint and are thickly infiltrated with pigment granules.

It is said that by washing this tissue two different kinds of pigment granules may be obtained, one kind unaffected by acetic, hydrochloric, and concentrated nitric acids, chlorine water or caustic potash, or even by boiling heat, showing it to be a kind of vegetable coal; whereas the other kind presented the character of an organic pigment, especially by being decomposed by nitric acid and chlorine as well as by caustic potash.

If Brockmann's researches were not at that time considered altogether decisive, no doubt at present remains as to the occurrence of these melanotic alterations in the lungs, and the details of his observations coincide perfectly, as we shall see, with the results of modern experimental enquiries. For although a part of the colouring of such lungs may be traceable to organic pigment deposited from the colouring matter of the blood, as Virchow's experiments have proved, and a part of the pigment granules which Brockmann described may possibly have originated in transformation of hæmatin, still the greater

part of such as he found in the pulmonary parenchyma and in the bronchial glands must be regarded as consisting of vegetable coal which had been inhaled and deposited in these situations.

Convincing as these post-mortem examinations seem to us now, the conclusion that coal or other colouring substances really made their way into the lungs was not accepted at that time, and, as the brown and black pigmentation of the lung had been observed even in cases where there had been no preceding exposure to an atmosphere impregnated with coal dust, it was referred rather to pathological processes in the respiratory and circulatory organs themselves and to the metamorphosis of the colouring matter of the blood into the different-coloured pigment granules.

In the assumption that pulmonary melanosis originated in deposit of pigment from the blood, the French authors were opposed to the English, who had been led to the contrary conclusion by observations among their colliers, and Christison and Graham proved by incontestable analyses that the black masses deposited in the lungs of colliers presented precisely the same chemical reactions as vegetable coal, and were clearly distinguishable from animal pigment. Nevertheless this vexed question remained unsettled, although the objections brought against the penetration of coal dust into the respiratory organs, and especially into the lungs, were supported less by actual observations and logical argument than by obstinate denial and untenable hypotheses, which it is unnecessary to consider further.

New and decisive facts in proof of the penetration of coal dust into the lungs have been brought forward more recently, first by Traube, who succeeded in ascertaining microscopically the morphological identity of the (possibly) inhaled dust with the masses deposited in the lungs. Traube observed in a patient who had been employed for many years in lading charcoal, that the sputa were of a more or less dark red colour, and contained black and red particles of the form and appearance of the coal in which he worked, and after the death of the patient he found in the dark black sections of both lungs small fragments of charcoal, some of them even enclosed within

the cells, whose origin could be as accurately traced to the coals amongst which the patient had been employed during life. Traube's statements were confirmed from different quarters during the following years, partly by means of experiment by inhalations of coal-dust and detection of it in the larynx and the trachea by the laryngoscope (Fournier), partly by experiments on animals (Lewin, Villaret, Rosenthal, and others), but the settlement of the question was not advanced by these researches. It was not till six years later that the question was finally decided by the observations and experiments of Zenker, who detected in the lungs a substance, viz. protoxide of iron, which could only have entered into them by inhalation, and found it in quite considerable quantities in all those places where the so-called normal lung pigment was usually to be found.

Contemporaneously with Zenker, Seltmann and Kussmaul published their observations, which supported in the most decided manner the fact of the penetration of particles of dust into the pulmonary tissue. The experimental labours of Knauff, V. Ins, and Ruppert, which also proved how rapidly infiltration of the lungs with dust may take place, under favourable conditions, further suggested the doubt whether the finely granulated black pigment occurring in the aged is really engendered in the organism, and whether it may not be possible that all the black pigment which, under certain circumstances, is deposited in the pulmonary parenchyma, but especially in the bronchial glands, may not have penetrated from without into the respiratory organs, and have been conveyed still deeper.

Lastly, we may mention in this place the pathological processes which were described by Zenker as 'morbid states of the lung produced by inhalation of dust,' and which have been treated of in detail by Lewin, Hirt, Heubner, and others.

Formerly, even before diseases caused by inhaling dust were regarded as a distinct species of malady, attention had been called to the extraordinary mortality among workmen of different callings and the frequency of pulmonary diseases among them, and the physicians who had made these observations attributed them to the inhalation of the dust-charged

atmosphere in which they worked (Ramazzini, Lombard, Johnston, Knight, Young, Peacock, &c.) Under the persistent mechanical irritation produced by the mineral substances which had penetrated into the pulmonary tissue, according to their respective properties, sometimes chronic inflammations are set up with very decided symptoms of disease, at other times the affection takes the form of an infiltration of the tissue and compression of the capillaries, followed by extensive disturbances of nutrition and the occurrence of necrobiotic processes, which further lead to exudations, to progressive atrophy, to phthisis, and to tuberculosis.

With regard to the conclusions which these observations furnish as to the pathology of pulmonary diseases and the statistics of disease and mortality among whole classes of the population, as well as with regard to other facts which are less interesting to us here, however much they may appear to be connected with our subject, we must refer to those works themselves to which we have only cursorily alluded.

## B. FLUIDS.

It is really incomprehensible how anyone can have doubted the penetration of fluids, pulverised so as to form a fine mist, into the air passages, and not rather have feared with Trousseau that the fluid dust into which a medicated solution has been pulverised might penetrate only too well and make its way not only into the deeper bronchia, but also into the air cells themselves in such quantity as, according to its nature, might exercise an irritant action and excite symptoms of inflammation.

In the mechanism of the respiratory organs the same conditions prevail for the penetration of fluid as of solid particles in fine subdivision, and the irritability of the mucous membrane, which actively opposes itself to all penetration when it is excited by some unaccustomed irritation, is no greater in respect of pulverised fluids than of pulverised solids; on the contrary, the contact with the moist mucous membrane of the delicate fluid particles would disturb its sensitiveness less, and whatever irritating effect they might cause would depend wholly (as in the case of solid bodies) on their quality, their quantity, their

temperature, and the mode of their penetration. It is in the physical properties alone of aqueous dust, as we have already said, that any impediment can arise to its entrance into the respiratory passages, so far as their anatomical arrangements are concerned, and the opponents of the penetration theory have made the most of this as a ground of opposition, both in the way of experiment and of discussion.

The fluid reduced to dust by a *pulvérisateur* is mechanically resolved into a countless number of the finest drops, which can float freely in larger or smaller interstices in the air saturated with aqueous vapour; and while the largest of these, by virtue of their gravity, tend to sink gradually and slowly to the ground, the finest and most delicate form little wreathing clouds of mist-like dust, which are carried along everywhere by the current of air. If this mist-like dust be drawn by inspiration into a narrow space, the little clouds are pressed together and the mist becomes denser. In this process, according to the condensation of the inspired air and the narrowness of the space it enters, many of these particles of dust will come into contact and condense into larger drops, and when they reach a certain degree of gravity they are no longer carried along by the current of air, but are deposited. Similarly other particles impinge on the walls of the air passages and become precipitated there and condensed into larger drops, so that the amount of spray which penetrates depends on the calibre of the canals and the windings and fissures through which the air has to pass.

These physical properties of fluid dust and the anatomical construction of a portion of the respiratory organs were strenuously insisted upon by the opponents of penetration, and though doubtless they have to be taken into account, they do in point of fact act in a manner quite otherwise than was imagined by them and as their experiments seemed to prove. It must be borne in mind that the form and capacity of the oral and nasal cavities and the larynx, as well as the position of the parts within them, are very different during calm, ordinary respiration with mouth partly closed, as we have shown, from what they are during voluntary, deep inspiration accompanied with voluntary efforts to remove all hindrances that oppose themselves to

the entrance of the inspired air. So with particles of fluid dust, if they are only fine enough, they do not entirely precipitate themselves against the walls even in passing through long, narrow canals, but pass along in a greater or smaller proportion with the current of air as it rushes through. We can now say, briefly and decidedly, that the question once so fiercely disputed, especially in France, and not altogether without personalities, has been decided in the affirmative by experiments both on animals and human beings in various quarters, as well as by therapeutic observations in the French Academy itself, and the dispute must be considered at an end. The researches to which the whole of this controversy gave rise have therefore still a general value, as they threw light on the physical and physiological processes concerned in the inhalation of pulverised fluids and established their relations to therapeutic processes, while the negative results of the contradictory experiments may be passed over in silence, as no longer possessing any scientific interest.

(a) *Experiments on Animals.*

Since animals breathe through the nose, the application of inferences drawn from inhalation experiments on them to the case of human beings can only be of partial value, even when performed under artificial conditions approximating their mode of respiration to that of human beings, as, e.g., when the nose is occluded and the mouth kept open. And even then the upper part of their respiratory canal bears no comparison with the funnel-shaped form so highly favourable for inhalation which we get in human beings, while the laborious, panting, and generally rapid and superficial breathing which enforced conditions produce cannot be of equal value with the voluntary inspirations of the human subject, so well adapted to inhalation. And though the way to the larynx and lungs is shorter, owing to the smallness of the animal's body, this advantage is negatived both by the narrowness of the air passages and the slight amount of inspiratory effort.

It is not to be wondered at, under such circumstances, when animals have been made to breathe pulverised fluids, breathing simply in the ordinary way through the nose, that

little or no results have been obtained, so trivial are these experiments in comparison with the methodical inhalations of human beings.

And yet in one of Briau's experiments the fluid used for inhalation (ferrocyanide of potassium) seems to have penetrated into the deeper air passages, and could be detected in the larynx, in the trachea, and in the larger and smaller bronchi. Claude Bernard found it also in the urine and in the kidneys of the rabbit, a circumstance which points much more to the rapid absorption of the salt by the respiratory mucous membrane than to its secondary excretion from the blood after accidental absorption by the stomach and intestine. On the other hand, in the experiments of Demarquay, Poggiale, Fieber, Lewin, Tobold, Gerhardt, in which the animals' mouths were kept open and the glosso-palatine isthmus kept free, the pulverised fluid could be detected all along the respiratory tract, and the evidence of the penetration of pulverised fluids into the air passages was thus fully established by experiment on animals.

(b) *Observations on Men.*

The question of the inhalation of pulverised fluids has always taken this form: Can fluids penetrate into certain definite parts or not? And since the relations of these parts furnish an essential part of the conditions upon which penetration seems to depend, it follows that observations on the human subject whose respiratory organs are alone the object of treatment are really and exclusively decisive for or against the method.

1. *Laryngoscopic Observations.*—The laryngoscopic mirror enables us to observe accurately the interior of the larynx, the trachea, and a portion of the bronchi; so that it is easy, after the inhalation of suitable (coloured) fluids, to convince ourselves by actual inspection if these fluids have penetrated into the respiratory organs and how far they have gone. Such experiments have yielded positive results, and the inhaled substances have been recognised and detected in the larynx and in the trachea.

Tavernier made experiments on himself by inhaling chloride



of iron and ferrocyanide of potassium. In inhaling the former as well as the latter, he felt a sensation of cold and constriction in the chest, which was followed by tickling and inclination to cough.

The laryngoscopic examination immediately disclosed the larynx above and below the vocal cords overlaid with a dark coating of Prussian blue. He then washed out his mouth and gargled his throat till the water flowed out colourless; and he next tested the expectoration. He coughed up some thick mucus, which was at first very strongly but unequally coloured; subsequently there was a discharge of bronchial mucus, which was equally coloured throughout.

Moura-Bourouillou performed similar experiments on himself, by inhaling the spray of a black fluid and examining its effect upon the surface of the mucous membrane of the larynx and of the trachea. He found, as he continued the inhalations, the several parts of the pharynx, the larynx, and the trachea became of a deeper and deeper shade of black, which gradually spread over the whole surface to a certain depth. The coloration occurred more rapidly when he breathed with the mouth only, and especially when he took deep inspirations. So also he observed the vocal cords, whose white colour is always very evident, were more or less blackened; the under surface of the epiglottis appeared less dark, and in the trachea also there was a difference to be detected between the surfaces of the annular cartilages and the spaces between them. Moura-Bourouillou expressed his conviction that inhaled fluids penetrate still deeper into the trachea, even though they were not to be detected by the laryngoscope.

Professor Gratiolet arrived at the same results by the same method; Bataille also, who suffered from chronic catarrh and was cured by inhalations of extract of rhatany, immediately examined with the mirror the red coloration of his larynx and trachea, and some hours later, after all trace of colouring had disappeared from those parts, he still continued to expectorate red mucus, thus affording convincing evidence that the extract had penetrated into the bronchi.

More recent experiments instituted by Fieber, Schnitzler, Sörk, Gerhardt, Lewin, and others have been followed by the

same results. Lastly, according to Semmeleder, if a concentrated solution of an astringent, such as tannin, chloride of iron, or alum, be inhaled, we can immediately detect an obvious pallor of the laryngeal mucous membrane, and mucus coagulated by the astringent may be seen clinging in the form of whitish flakes to different parts of the larynx and trachea. I performed several such experiments in the years 1863 and 1864, and demonstrated my larynx after inhalations of Prussian blue to my colleagues.

It is impossible to obtain a stronger proof than these laryngoscopic experiments afford not only of the fact that medicated fluids penetrate into the trachea and into the bronchi, but also that they enter (as the colourings with Prussian blue show) in a quantity and concentration which can completely answer to the special indications of the affection of the mucous membrane which may exist.

2. *Observations through Tracheal Fistulae in Laryngeal Stenosis.*—Even under altogether abnormal conditions the pulverised fluid will force its way through narrow fissures of the glottis, quite insufficient for respiration, originating in destructive pathological processes, and necessitating the production of a tracheal fistula. Cases such as these prove that even through apertures too narrow for the atmospheric air necessary for life to pass in, in sufficient quantity, yet fluid dust, as such, is conveyed along with the inspired air, and does not condense into drops and precipitate itself upon the walls, as was stated in antagonism to the inhalation theory, partly theoretically, partly in consequence of faulty experiments.

The first experiment of this kind was tried by Demarquay in a tracheotomised nurse on whom Fournier had previously experimented without result. A strip of paper saturated with solution of chloride of iron was laid in the tracheal aperture, the occlusion of which the woman bore for only a very short time; over it a strip of court-plaster was fixed, the whole covered with a towel; then a Matthieu's apparatus, pulverising a 1 per cent. solution of tannin, was placed opposite to the woman at a distance of 25 centimetres. In order that the experiment should succeed, the canula had to be closed hermetically during the inhalation, so that the stream of air should

pass directly through the narrowed glottis, and this was difficult to accomplish by reason of the great prominence of the sternocleidomastoid muscles and the consequent deepening of the opening in the trachea. Accordingly the experiment twice failed, owing to the shifting of the strips of paper and the sticking-plaster. The third time, however, when Demarquay closed the aperture of the canula with his finger, he succeeded completely, and the strip of paper was drawn out coloured black to a great extent. Demarquay also performed a similar experiment on a dog, in whom a tracheal fistula had been made. Under the same conditions Fieber, Schnitzler and Störk, and Gerhardt, following Demarquay's process, experimented on a tracheotomised patient and obtained similar positive results.

3. *Post-mortem Observations.*—The penetration of fluid dust into the lungs of the human subject has been proved post mortem in two cases of hæmoptysis, where the patients, shortly before their deaths, had inhaled a strong solution of perchloride of iron.

In one of the cases (Zdekauer) in the right lung there were found considerable insulated hæmoptoic infarcts, very tough and not bleeding on incision; in the left lung low down similar but far smaller infarcts were found. Dr. Holm examined these hæmoptoic infarcts, and detected all through the pulmonary tissue iron in a far greater quantity than is usually present in the blood. This increased quantity of iron in the pulmonary tissue could only be explained by the direct penetration of the inhaled solution of chloride of iron into the pulmonary alveoles.

The second case (Lewin) was that of a patient with pulmonary hæmorrhage, whom Lewin treated in Professor Frerichs' clinique in the Berlin Charité with inhalations of chloride of iron, and who succumbed, notwithstanding the arrest of the hæmorrhage. On post-mortem examination the inferior portion of the right upper lobe was found transformed into a sac with thin walls which adhered firmly to the wall of the chest. Out of this flowed a black fluid with blackish shreds of lung-tissue, also some dark red clots of coagulated blood. The inferior lobe was tolerably firm; upon its incised surface were seen numerous prominent, greyish white infiltrations. The rest of the tissue was void of air, and upon pressure discharged some dirty fluid.

The middle lobe and the lower part of the upper lobe showed broncho-pneumonic infiltrations surrounded by œdematous tissue. The bronchi were moderately dilated, and mostly filled with dirty brownish fluid.

The blackish fluid found in the cavity described above in the lower part of the right upper lobe was examined immediately after removal by the chemical assistant, Dr. Schulz, and yielded, as well as the dark clots, free iron, but only in a small quantity. Thus, then, the most conclusive evidence was given of the penetration of the inhaled medicament into the lungs.

4. Attempts have been made to draw conclusions as to the actual penetration of medicated solutions into the deeper portions of the air passages and into the lungs by testing for the inhaled substances in the sputa and in the urine, as well as from the subjective sensations observed by the patient during inhalation.

But such arguments afford no direct evidence and are only of relative value, and the observations which serve as a foundation to them have but little interest in themselves. The detection of inhaled substances in the sputa has no value unless the inhalations have been conducted by the experimenter himself, after the manner of Tavernier and Moura-Bourouillou and others, with very careful precautions, and where, after thorough cleansing of the respiratory tract, the mucus has been expectorated by deep coughing; otherwise the expectorated masses may proceed from the pharyngeal cavity, and from the other parts lying above the glottis, or may be discoloured by them.

Similarly, the detection of inhaled substances in the urine affords no evidence that their absorption took place from the mucous membrane of the air passages and from the lungs, as they might also have reached the blood from the oral cavity and from the pharyngeal mucous membrane, and, in case they had been in part swallowed, from the stomach, and excreted through the kidneys. It is only when, as in the case of Briau and others, the mucous membrane of the air passages has been found deeply infiltrated with these substances as far as the finer bronchi, and they are then found at the same time in the urine, that there is certainly a great probability that the absorption has taken place from the pulmonary surface, as the opposite

view would involve the belief that the substance had been swallowed into the stomach, and after absorption had been eliminated from the blood through the mucous membrane of the air passages.

Finally, as regards the subjective sensations, the mucous membrane of the respiratory organs possesses very slight sensitiveness to contact or power of localising sensations, so that we cannot receive from it a clear consciousness either of the impressions which act upon them or of the place where they act. When water of the ordinary temperature of the room or a weak saline solution is inhaled, nothing is observable except a slight irritating cough or tickling, generally only in the larynx, more rarely in the trachea also, and a sensation of local cold. If, on the other hand, concentrated solutions of tannin or chloride of iron are inhaled, a more burning sensation is produced in the larynx and in the trachea, along the sternum, which may extend to both sides of the chest.

The subjective feelings which the patient experiences in inhaling medicated fluids may convince him, and perhaps the experimenter also, that the fluid dust penetrates into his respiratory organs; but it does not follow, as in most subjective sensations, that they can be trusted to as accurately fixing the locality of the part that is reached. No scientific importance can therefore be attached, in the question under discussion, to the subjective sensations produced by the penetration of the fluid dust into the trachea.

### (c) *Experiments with Artificial Apparatus.*

If by means of artificial apparatus we desire to prove the possibility of pulverised fluid penetrating through tubes of various diameters and condensing within them, and if we desire to argue from the results thus obtained to the possibility of obtaining similar results in the respiratory organs of the human subject, the success of this experiment will depend on two conditions. First, the inhalatory aperture leading to these tubes of various calibre must possess a funnel-shaped dilatation, resembling that formed by the open oral, pharyngeal, and laryngeal cavities; and secondly, the terminal aperture of the tubes must be connected with an aspiration apparatus, which, under

sufficiently high pressure, will draw in the air with the same suction power as in human inspiration.

Particles of pulverised fluid, when sufficiently finely divided to be capable of being inhaled, float, owing to the reduction of their weight, freely in the air and follow its currents upwards and downwards, till after some time, as the aqueous vapour with which the air is at the same time saturated gradually condenses, they precipitate themselves in larger drops; or, if the temperature is sufficiently high, they pass into vapour. Pulverised fluids, even when they enter vertical tubes, like the human trachea, do not follow their own gravity, but follow the movements of the air current, produced either in the pulverising apparatus itself by means of compressed air or steam, or brought about by the suction power of an aspiratory apparatus. If both forces act together, the suction action on the fluid particles will be exactly that of the resultant of the two forces; hence, therefore, when one of the forces is incomparably greater than the other, the fluid particles cannot be diverted by the latter from the original direction of the movement impressed upon them by the first force. This will be especially the case the larger the particles into which the fluid is reduced, and therefore the heavier they are. And so it will happen, if the pulverised fluid be driven in a horizontal direction by the force of a strongly compressed atmosphere in Matthieu's or Bergson's apparatus or by the high tension of aqueous vapour, as in Siegle's apparatus, especially when the apertures of outlet are not very accurately constructed, it will be impossible, or only possible in a very slight degree, for the feeble inspiratory action of a tuberculous patient to divert it from its path, and it will strike against the posterior pharyngeal wall, and no portion worth naming will ever reach the larynx. If on the other hand, as in the apparatus of Sales-Girons and Lewin, or the better constructed forms of Siegle's steam apparatus, the movement given to the particles of spray in their pulverisation is only a slight and vanishing one, and their size, and therefore their weight, is as small as possible, then they follow every impulse which the air in which they find themselves receives from without. They whirl up and down, like the aqueous particles in a fog cloud,

and may easily be blown away in any direction. The fluid dust can only penetrate and pass through even vertical tubes, such as the human trachea, when it is forcibly driven in or aspired with the air; and its own gravity, carrying it down vertically, is rather a hindrance than a help, as, like the preponderating horizontal force in the former case, it carries the fluid irresistibly downwards, so that the heavier particles can no longer follow the atmospheric current in its horizontal or curvilinear direction, but either sink at once to the bottom or strike against the walls of the tube.

Taking into consideration these mechanical effects of the movement of pulverised fluids, it is now easy to show how such particles can pass through tubes varying in calibre, when even they are very tortuous, while it follows from the condensation of the air, when it is driven or aspired through such tubes, that a portion of the fluid dust runs together into small drops, which are deposited on the sides of the upper part of the tube. Thus Waldenburg caused pulverised fluid to pass through an indiarubber tube 10'' in length and  $\frac{3}{8}$ '' in diameter, even when the tube was bent backwards or twisted, and its terminal orifice turned upwards, downwards, or to the side. Even when the tube was somewhat compressed at one spot (in imitation of the epiglottis)—of course not so as to entirely close up the passage—the fluid stream still made its way through it.

The longer and narrower the tube is, the finer is the mist that passes through it, as the larger particles are all detained in the upper part of it, and only the finer particles are capable of passing through long, narrow, and twisted tubes (Waldenburg).

Siegle also caused a spray to pass through a tortuous tube, and succeeded in showing the evident presence of iron in the fluid dust by tannin test-paper, even at a distance of 5' from the outlet.

Lastly, similar positive results were obtained by artificial apparatus composed of guttapercha and papier mâché, in which the human organ was closely imitated by Sales-Girons, Moura-Bourouillou, Schnitzler, and Waldenburg, and the penetration of the pulverised fluid into the artificial channel was demonstrated in the most convincing manner.

Such being the results of these experiments, it would be

difficult to conceive that similar conditions should lead to different results in the living subject, and that more serious hindrances should be encountered to the penetration of the pulverised fluid into the air passages and into the lungs than is the case in artificial apparatus, as the agencies leading to the penetration of this substance present no essential differences in the two cases, but, on the contrary, a considerable part of the hindrances is overcome in the human subject by the voluntary performance of actions contributing to the end in view, whereas there are many drawbacks to be overcome in the experiments with such apparatus. We may therefore apply directly to the process of inhalation of pulverised fluid in the human subject all the observations and results which we obtain by experiment on the mechanical behaviour of this substance and its penetration into simple and compound, straight and curved tubes.

### C. GASES AND VAPOURS.

After our investigation into the penetration of bodies in the solid and fluid state into the respiratory organs, we pass on now to the consideration of those which are either naturally, i.e. under ordinary circumstances, found in an aeriform condition, such as gases, or which are brought into that condition only by elevation of their temperature, such as fumes and vapours.

There is nothing in the physical constitution of gases to prevent them, either alone or mixed with air, from entering the lungs with every inspiration, though they differ essentially from one another in chemical characters. Some, as soon as they penetrate into the air passages, act as irritants to the mucous membrane, and prevent respiration; these are irrespirable gases. But even the respirable gases may irritate the glottis, in the same way as pulverised fluids, if they enter the air passages under too strong pressure or at too high or too low a temperature, although in other respects they are well adapted for inhalations.

The same observation applies to fumes and vapours, and if they are to be inhaled by the respiratory organs without irritation, attention must be paid to these physical conditions; and considering, in contrast to the gases, their relative dependence



on fixed degrees of heat, their capability of penetrating into the air passages will greatly depend on the temperature at which they are developed, and so, when their temperature is too high, it will become necessary to cool them.

In closest relation to the gases stand the ethers, ethereal oils, and other chemical substances, which are vaporisable at a low temperature, a temperature which can readily be borne by the respiratory mucous membrane. Such bodies can be inhaled deeply without exciting any kind of irritation either in the trachea, bronchi, or lungs, either unmixed, if their chemical properties admit of it, or diluted with a due proportion of atmospheric air or aqueous vapour, if they are likely to excite coughing when inhaled pure.

Other conditions come into play in the case of aqueous vapours, if they are to be inhaled either alone or combined with aromatic and other volatile substances. Since it requires a temperature of 100° C. to convert water into steam, the vapours which are developed by boiling possess too high a temperature to be inhaled without cooling. The direct result, however, of this cooling process is the condensation of a part of the steam into water in the form of small particles, only so much water remaining in the form of vapour as the air can retain at that low temperature; water particles, aqueous vapour, and atmospheric air form a dense, intimate mixture, a kind of mist,<sup>1</sup> which forms white visible cloudlets and is alone suited for inhalation. The proportion of mist in aqueous vapour is in direct ratio to its temperature. In its physical properties it stands between aqueous vapour and pulverised fluid, a part of it being, like the latter, fluid water, in a particular form, mixed with actual vapour and atmospheric air. When this mist is to pass unaltered, as such, through long bent or tortuous tubes, it is important that no alteration of its temperature, and especially no cooling by the walls of the tube, should take place; otherwise the steam becomes condensed more and more into water,

<sup>1</sup> 'Schwaden,' which I have here and elsewhere translated 'mist,' as its nearest English equivalent, Professor Oertel uses to designate the moist cloud which is inhaled from hot steaming fluids, and which consists of steam and the results of its partial condensation through contact with cold air and the air itself.—Tr.

which is deposited upon the walls of the tube, and at last only a very little, or even no mist and steam emerge from the tube. Special attention must be paid to these considerations in inhalations of aqueous vapours, when they are conducted through long pipes of caoutchouc or other material in which such an amount of cooling may take place as to condense all the steam into water, which flows out of the tube.

The vapours of sublimable solid bodies behave in the same way as aqueous vapours, especially that of sal ammoniac when it is heated, for the vapours of sal ammoniac immediately experience a sudden cooling from contact with the air, and become condensed into a white cloud, a mist, which no longer consists of sal ammoniac in a state of vapour, but of sal ammoniac in sublimed particles, which are carried through the heated air in the form of minute crystals, and are gradually deposited as a white powder. If the sal-ammoniac mist comes into contact with a moist surface, the smallest quantity of water suffices to dissolve the minute sublimed particles, and to retain them. Sal-ammoniac mist, generated by passing ammoniacal vapours through hydrochloric acid, differs only from that produced by sublimation at a high temperature in the manner of its formation and the consequent warmth of the resulting mist.

The vapours of mercury, arsenic, &c., behave in the same way as sal-ammoniac vapours. The employment, however, of these preparations in the form of vapour is very limited, as the inhalation of the pulverised solution is more useful.

According to these investigations and the theoretical conclusions derived from them, we may regard the question of the penetration of solid, fluid, and aeriform bodies into the air passages and lungs by inhalation as practically settled. Bodies are involuntarily carried into the respiratory organs by the inspiratory current. Regard must be had to their usual physical condition, and various modes of procedure must be adopted according to the form and mechanical subdivision in which they are to be used, so that it becomes possible, with certain precautions, and with the aid of necessary apparatus, to bring almost the majority of active medicaments to bear upon the mucous membrane of the nose, the oral and pharyngeal cavities, the larynx, the trachea, the bronchi, and even upon the pulmonary surface itself.

The advantages which result from the direct contact of medicinal agents with the diseased surface of these organs, and their transmission thence into the tissues, have always been so evident, that the adoption of this mode of application was certain as soon as the right method had been discovered. Now that this and the necessary conditions for its application are at our service, we have the means of constructing a general therapeutic system of procedure which guarantees the principles of an exact treatment.

### MODE OF ACTION OF MEDICINAL INHALATIONS.

The application of medicinal agents to the surface of the respiratory organs differs quite specifically from simple surgical applications as well as from their internal administration, not only in that it takes place in the same direct manner as the former, instead of by the circuitous route which drugs take to the part upon which they are to act after absorption from the stomach and intestine through the blood, but also because it can only be carried out by means of apparatus and vehicles in a peculiar form, which themselves exercise secondary influences.

Although treatment by inhalation is to be regarded pre-eminently as a local treatment of the respiratory organs, by which the inhaled substances are brought into direct contact with them, and exert a directly alterative influence on pathological processes, yet, at the same time, a premeditated or non-premeditated general effect by absorption of the remedies employed is not excluded, especially when the surface to which they are applied is extraordinarily large and its capacity for absorption very considerable.

In considering the action of remedies applied in the form of inhalations, we shall therefore have to mark essential differences in their mode of action, especially in the following points. In the first place the mode of action of inhalations must be regarded as twofold.

1. A part of the effects will depend upon the natural physical condition of the medicinal substances and the form and mode of application which this necessitates. This mode of

action, therefore, is exclusively dependent upon the method adopted.

2. On the other hand, the medicines act according to their pharmacological properties, and this mode of action is again twofold—

(a) Local, i.e. limited to the tissues with which they come into contact ;

(b) General, through absorption from the surface of the mucous membrane and of the lungs.

The pharmacological action is supported and modified by the first, which may be designated the special action of inhalations. The pharmacological properties of the medicinal substances determine their respective applications, which is dependent on distinct indications, and this forms the subject of the pharmacological and therapeutic part of the treatment by inhalations. The special action of inhalations must be considered as common to all the medicinal agents employed in their various physical conditions, and will be so described.

#### SPECIAL ACTION OF INHALATIONS.

The special mode of action of inhalations is essentially dependent on the physical condition of the medicines which are to be inhaled, and on the mode of action of the apparatus employed, which differ according to the nature of the motive power upon which their activity depends. The more suitable the physical condition of a body is for inhalation, the less need there will be for the co-operation of artificial apparatus and supplementary agents, and the more will the special mode of action of inhalations retire into the background, and the more prominent will become the pharmacological part.

##### 1. *Gaseous Bodies.*

Gaseous bodies, which behave towards the respiratory organs like atmospheric air, require, when they are once prepared, no further contrivances for their inhalation, and may be directly inspired out of the receptacle in which they are kept, either pure or diluted with atmospheric air and at the same temperature. As in this case no particular kind of apparatus is used

for facilitating inhalation or producing any special action of the inhalent, as such, we have only to consider the pharmacological action of the gas employed.

When gases are inhaled, they at once, as a result of their property of expansion, diffuse themselves uniformly through the respiratory organs, and by their absorption (which takes place not so much from the respiratory mucous membrane as from the general pulmonary surface and its capillaries) exercise less of a local than a general action.

## 2. *Solid Bodies.*

Next to the purely pharmacological mode of action of the gases we must place the mode of action of solid bodies, if they are inhaled in the form of fine dust or conveyed in any other manner to the respiratory mucous membrane.

In the case of solid bodies also it is chiefly their pharmacological properties which determine their therapeutic effects, and no special modification is needed in their mode of application, which may be quite simple and uncombined with other influential factors. By their solubility in water, on the other hand, they approach the action of fluid medicines, which can often also be substituted for them, but with this difference, that solid bodies withdraw the water necessary for their solution from the mucous membrane itself.

Retention of the solid state during their application also forms an important part of their pharmacological properties, rendering their action much more energetic than if they had been inhaled in solution. Solids insoluble in water are no longer used therapeutically; yet many bodies, such as nitrate of silver and other metallic salts, whether they are applied in the form of powder or in solution, form insoluble compounds with the albumen and mucus of the secretions and tissues, and then naturally share the fate of insoluble bodies.

Just like the dust inhaled by various mechanics, a part of these insoluble compounds will come away with the secretions and be expectorated by the patient; another part, however, is absorbed by the respiratory organs themselves. These solid bodies are absorbed from all parts of the respiratory organs—

from the air-tubes, the larynx, trachea and bronchi, as well as from the pulmonary alveoli—and the process is the same in all, as may be directly observed in animals after the artificial introduction of particles of dust, such as coal, soot, cinnabar, and powdered quartz. Whether canals between the epithelial cells pre-exist, through which these substances pass into the tissues, cannot yet be demonstrated with certainty, though it is highly probable, for their transmission takes place with extraordinary rapidity. From the irritation produced by these insoluble bodies, and also probably by the indifferent substances formed by their combination with albumen, or by (blood) coagulation, there follows a considerable exudation of large round cells in the pulmonary alveoli, having homogeneous protoplasmic contents and a diameter about two to four times that of a red blood corpuscle. By means of these cells and their contractility, as Von Ins first demonstrated, and as I have frequently myself observed, a great part of these substances is taken up, and by their migration into the tissues and the lymphatic vessels is carried along and deposited in various parts of the respiratory apparatus. Moreover, the hypothesis which appears to me very well founded, that a considerable portion of the substances inhaled in the form of dust may pass directly into the tissues and accumulate within certain parts of the lymphatic system, is not yet refuted. If we observe experimentally the passage of foreign bodies—particles of cinnabar, for instance—into the tissues, we may detect in the lungs, from 6 to 12 hours after their insufflation, particles of cinnabar deposited at numerous points (glandular) in the alveolar septa, the framework of which, in the rabbit, consists evidently of reticular connective tissue forming the first indication of glandular organs, and terminating in the lymphatic vessels. In its further course the cinnabar accumulates in the stroma of the lung wherever the connective tissue is abundant and the lymphatic vessels are numerous. Whereas at first a great mass of dust-containing cells accumulates behind the strong ring of elastic fibres which surrounds the orifice of the infundibula in the alveolar passages, and in somewhat smaller numbers around the orifices of the alveoli, later on they are found in abundance in the adventitia of the vessels and of the bronchi between the lobules and in the sub-

pleural tissue. Finally, Ruppert, after exposing a rabbit for two hours to smoke, detected particles of soot, and Von Ins particles of cinnabar, after insufflations of this body, in the cortical substance of the bronchial glands. After three days you may also find granules of cinnabar enclosed in the cells of the follicles as well as those of the follicular striæ of the medullary substance. Von Ins has also observed in rabbits, into whose trachea blood had escaped during tracheotomy, yellow pigment granules, derived from the colouring matter of the blood, as well as cells containing cinnabar in the follicles and especially in the follicular striæ. I myself found such cells in the bronchial glands of a young man who died of tuberculosis, and who had had a profuse hæmoptysis two days before his death. These experiments, showing the regularity, and above all the extraordinary rapidity, with which inhaled insoluble powders as well as coagulated blood are absorbed in the lungs and pass into the bronchial glands, are of special importance, and we shall therefore have to consider these facts from a pathological as well as a therapeutic point of view.

The use of pulverised medicinal substances in the treatment of diseases of the respiratory organs is at present chiefly limited to their insufflation into the pharynx and larynx, as it is impossible to diffuse the pulverised substances sufficiently finely and equally over any extent of the diseased mucous membrane. They almost always tend to accumulate in some places in larger quantity than in others, and, as they generally belong to the class of the astringents or caustics, they may excite violent inflammatory and corrosive action in these situations; and even hæmorrhages may occur at those spots, should they be very vulnerable.

The indications for their use, therefore, are confined to the torpid, chronic forms of pharyngeal and laryngeal catarrh, and the insufflation of the powder is either made by the physician or the patient himself applies it by aspiration through a glass tube or a quill. In both modes of application the bronchi and the lungs are protected from the penetration of any considerable quantity of the different powders by careful insufflation, especially into the larynx, while the patient is made to utter some sound, or by making shallow inspirations, if the application is left to the patient himself.

### 3. *Fluids.*

The action of inhalations of aqueous solutions depends much upon the complexity of the means adopted for their pulverisation.

From the construction of the apparatus at present at our disposal, the fluid is pulverised either by water pressure or by compressed air or steam, and thus in their application forces are brought into play which may influence to a considerable degree the therapeutic effect. We have also to consider the physical properties of pulverised water and the anatomical relations of the respiratory organs themselves, different parts of which absorb the fluid dust in different quantities, and produce not unimportant changes even in its quality.

We will now consider in detail the modifications in the action of pulverised fluids when inhaled, and estimate the different causes which determine these modifications. The action of inhalations is chiefly modified by—

1. The quantity of the fluid dust in relation to the anatomical disposition of the respiratory organs, independently of external influences.

(a) The greater part of the fluid inhaled is deposited first in the mouth and pharynx, and then in the larynx and the trachea, and accumulates in drops on their mucous membrane, thereby completely irrigating it. Hence in diseases of these organs the pharmacological action of these solutions will be far-reaching and energetic, and they are therefore especially suitable for inhalatory treatment.

(b) The deeper the fluid dust penetrates downwards and into the bronchi, the less there will be deposited in the form of drops on the mucous membrane. Nevertheless the fluid particles produce their effect, which is considerably strengthened by the constant trickling down of the fluid when the inhalations are of long duration, the therapeutic result being thereby enhanced.

(c) The fluid dust inhaled will attain the highest degree of attenuation in the finest ramifications of the bronchi and in the air cells, and as the temperature of the air in the lungs is nearly as high as that of the blood, the mist-like finely pulve-



rised particles of water are in a condition to become converted with extraordinary facility into vapour, so that it is not improbable that what is already a steamy mist may, in the smaller bronchi and the lungs, be converted into actual vapour. It may also convey along with it in this form, in solution as well as in suspension, the exceedingly finely divided medicinal substances contained in it. The influence of such an atmosphere on the surface of the lungs will not be very energetic, since the quantity of the medicinal agent contained in it is small; but, by reason of the vulnerability and anatomical character of the surface on which it is to act, it will be sufficient to produce distinct therapeutic effects.

2. Another peculiarity in the action of inhalations which is of weighty consideration even in the inhalation of solid bodies is the extraordinary absorbent capacity not only of the air passages, but especially of the pulmonary surface, which is still further increased by the favourable physical condition (for absorption) of the inhaled remedies and by the long duration of the process through which the pulverised fluid is brought into continuous contact with the surface of the lungs. The passage of medicinal substances through the respiratory organs into the blood, and thence into the soft tissues generally, is excessively rapid.

Although iodine can be detected in the urine of patients a short time after they have inhaled a solution of iodide of potassium, this fact cannot be regarded as affording conclusive evidence of the absorption of the medicine by the respiratory mucous membrane and the lungs, since a part of the inhaled fluid might have been swallowed and have passed from the stomach into the blood; the fact is, however, directly demonstrated by the easily repeated experiment of Auphan. If you open the trachea of a rabbit and inject into the bronchi a solution of iodide of potassium, generally after ten to fifteen minutes no trace of it is to be found in the air passages or in the lungs. Ruppert injected into the lungs of frogs Indian ink dissolved in a 0.6 per cent. solution of common salt, and he observed that this mixture, if the animals were made to retain it, passed into the circulation with the greatest rapidity. Only an hour after he found the lungs almost perfectly empty,

while the capillaries of all the organs were most beautifully injected. At the same time a portion of the Indian ink was eliminated with extraordinary rapidity by the urine, which in the space of a few minutes became as black as coal.

The passage of the fluids may take place either in part through communicating canals between the epithelial cells—a hypothesis which has much probability on its side—in part by endosmosis into the lymph spaces and lymphatic vessels, and even into the capillaries themselves. The absorption and transmission of substances through the lymph stream will also be specially influenced by the continual change of form in the way of expansion and contraction which the lung undergoes in respiration. We must also bear in mind that the capillary network surrounding the alveoli is separated from the external atmosphere only by a delicate membrane and a single layer of epithelium, and their ramifications unite to form the pulmonary veins which convey the blood at once to the left side of the heart, so that medicated fluids which come into contact with the alveolar walls reach in a very short time the circulation in the general mass of the tissues. In this way Gerhardt administered successfully by inhalation 0·5 to 0·10 per cent. solutions of bicarbonate of soda in diseases of the mitral valve, for there is no way by which medicines can be brought so rapidly into contact with the endocardium and the cardiac valves as through the pulmonary veins. So also in mycotic endocarditis we can scarcely adopt a more rational mode of treatment than to endeavour to exert a direct influence over the bacteroid vegetations on the endocardium and in the cardiac muscle by the administration of inhalations of antiparasitic remedies, such as carbolic acid, benzoate of soda, salicylic acid, &c.

Lastly, the free and rapid absorption from the lung enables us to combine general with local treatment, or at any rate by the judicious selection of remedies to exercise at the same time an influence over the constitutional state, as, for instance, by inhalations of ferruginous salts, such as liquor ferri perchloridi, in the case of anæmic patients, instead of alum and tannin, when the presence of bronchial affections calls for the use of these remedies. We must, on the other hand, be on our guard lest we give rise to general secondary effects, where they are

either unnecessary or where, as in the free absorption of narcotics or silver salts, they would be attended by injurious results.

Easy, however, as it is to induce rapidly the general action of medicines through the lungs, we should adopt this plan only in very special cases, and wherever our object is to produce a general effect it is better to have recourse to internal administration or to subcutaneous injection.

3. Among the medical agents which are inhaled in aqueous solution, we must not omit to consider water itself, which is by no means an indifferent fluid in its behaviour towards the cells and tissues. But, apart from this influence, the inspiratory air being completely saturated with aqueous vapour, as it preserves its degree of saturation even in the higher temperature of the deeper air passages and of the lungs by the transformation of aqueous particles into aqueous vapour, it will prevent the evaporation of water from the surface of the respiratory organs during the whole time of the inhalation; and whereas in ordinary respiration a constant change takes place in the quantity of moisture surrounding the respiratory organs through the relative dryness of the inspired and moistness of the expired air, the effect, in this case, will be to maintain, as nearly as possible, uniformity in the aqueous contents of both inspired and expired air.

And further, since the medicated fluid in the form of innumerable minute drops penetrates into the air passages, and is precipitated upon the walls, the surfaces of these passages, so far as the drops, as such, can reach—i.e. the mucous membrane of the pharynx, the larynx, and the trachea—will be constantly irrigated with water and exposed to its action. This water moistens the layer of epithelium and the subjacent tissues, liquefies the tough secretions adhering to it, and facilitates their removal, relieves the feeling of heat and dryness, and thus, even more than the water-saturated atmosphere, alleviates persistent conditions of irritation and acts as an anodyne in most acute and chronic diseases.

4. Temperature. One advantage over the older method of respiratory therapeutics, which was limited to the application of vapours generated under a more or less high temperature, is

the great range of temperature we are enabled to employ by means of the various apparatus in use, according as their motive power is derived from compression of the fluid, or from atmospheric pressure, or from steam. The differences of temperature which may be produced in this way are considerable, and range from  $5^{\circ}$  to  $45^{\circ}$  C.

As it is by no means a matter of indifference, both with regard to the feelings of the patient and the course of the disease itself, whether a medicated fluid be inhaled at a temperature of  $5^{\circ}$ , or at one of  $30^{\circ}$  to  $40^{\circ}$  or more, this newly discovered method possesses an essential advantage, in that the medicine is not only applied at an agreeable temperature, but that we are enabled to combine with it the specific effect of heat and cold. Thus in many inflammatory processes, running an acute or subacute course, inhalations of cold water or ice water produce a very soothing effect on the mucous membrane, relieving pain and giving rise to a grateful refreshing feeling; whereas in more erethic affections they are not so well borne; these require higher degrees of temperature, which exercise a rapidly favourable influence on their course.

The continuous energetic application of heat also exerts an important influence over the development of inflammatory processes, and by means of heat, especially moist heat, we can promote or hasten suppuration, and so shorten the course of the malady. The muco-serous and somewhat watery secretion in catarrhal affections of the mucous membranes may by this means be converted into a purulent one; so also in affections of the parenchyma, by energetic promotion of suppuration we may encourage the formation of abscesses, especially in inflammations attended with fibrinous exudations, whether the consequence of diphtheria, croup, scarlet fever, or other diseases; and by the application of heat we may rapidly bring about a delimiting suppuration with purulent infiltration and separation of the membranes. Although in all these processes the therapeutic effect is really due to the heat employed, yet in the majority of cases it is necessary to combine with the action of heat either simple cleansing, solvent remedies, or strong disinfectants and germicides, and this system can be most advantageously carried out by methodical inhalations.

As a rule moderate degrees of temperature, such as are obtainable by the steam apparatus, suffice; but higher temperatures are very well borne, whereas a considerable reduction of temperature is but rarely employed, and its application is only possible to the upper portion of the respiratory tract; as it penetrates deeper, the pulverised fluid generally gets warmer, and its temperature approaches that of the body itself.

5. Mode of application. In addition to the circumstance that the medicated fluid, by its reduction to a very fine powder, is rendered very readily absorbable, and that by its frequently repeated applications, each lasting from ten to twenty minutes, it is kept for a long time in contact with the respiratory surface, there is another circumstance which also influences the treatment in a special manner, and that is the manner in which the pulverised fluid is brought into contact with the respiratory organs, whether by gentle afflation and irrigation with fine dust-like rain or by vigorous douching.

If in acute inflammations and ulcerations the moist warm air of the inhalations and the irrigation of the painful spots with pulverised fluids, and even with simple spring water, exercises a beneficial effect and carries away secretions and purulent matter without causing irritation, so in torpid conditions of the palate and the pharynx, when we wish to detach hard, viscous incrustations and to remove the tough layers of mucus, which completely hinder endosmosis and the absorption of the medicaments applied, it is only by an energetic stream and by vigorous douching that we can bring about the desired result.

This mechanical effect of course only comes into operation in affections of such visible parts as the pharynx, scarcely at all in the larynx; for the fluid dust, as it penetrates deeper, is not set in motion by the pulverising power of the apparatus, but by the resultant of that and the aspiratory power of the patient, and is no longer capable of exercising any mechanical shock. Finally, in the bronchi and lungs, into which only the finest particles of the pulverised fluid arrive—for all the larger droplets have previously become precipitated—the water in the solution employed acts more after the manner of steam, and produces the sensation of a current of air coming into contact

with the bronchial mucous membrane, which is distinguished from atmospheric air by the temperature of the penetrating mist.

#### 4. *Of Vapours and Mist.*

We now pass from the consideration of the fluids to that of those medicines which are applied in the form of vapour, whose mode of action most nearly approaches that modification of pulverised fluid which, like a fine cloud, penetrates in the form of mist into the narrowest ramifications of the bronchi and into the pulmonary alveoles.

Vapours and mists, in common with pulverised fluids, may produce an effect by means of their heat and of the water contained in them, as well as by the pharmacological properties of the medicinal agents which they contain, but they exercise no mechanical effect, and the ranges of temperature within which vapours can be applied are very limited. As a result of their expansibility and elasticity they diffuse themselves equally over the whole of the respiratory tract and throughout the lungs; but of course the mouth, pharynx, and larynx are not so much exposed to their influence as is the case with pulverised fluids. On account of these properties vapours and mists are more like gases in their mode of action, especially as the vaporised medicinal agents are, like gases, absorbed rather by the pulmonary surface itself than by the mucous membrane of the air passages.

The vapours of those medicines which volatilise at a low temperature behave precisely like gases, and can therefore, like them, be used for inhalation, without any intervening agency. Nevertheless the majority of them, such as ethereal oils, creosote, bromine, &c., differ from the gases in this particular, that, according to their pharmacological properties, they exert a greater local influence upon the parts with which they come into contact, and, what is of more interest to us here, that they are largely employed not for their own effect only, but in combination with other agents, such as hot aqueous vapours, the vapours of aromatic substances, infusions, &c., so that we must take into account the action of heat and moisture together with their own pharmacological action, in their case as well as in the case of vapours and mists.

## APPARATUS.

## I. FOR THE PULVERISATION AND INHALATION OF MEDICATED FLUIDS.

The apparatus which are at our command for the pulverisation of medicated solutions differ in their action, chiefly according to the principle on which they are constructed, or rather according to the motive power by which the fluid is pulverised. And for this reason the selection of them is not left to individual choice or accident, but is determined by the indications for treatment which present themselves in each special case.

From this point of view the apparatus hitherto constructed for the pulverisation of medicinal fluids may be grouped under the following classes :—

1. *Sales-Girons' Apparatus.*

The pulverisation of the medicated fluid is effected by forcibly driving a fine jet of the fluid against a solid body, such as a disc of metal, and by this means the jet is reduced into the finest powder.

Sales-Girons' easily transportable apparatus, the *pulvérisateur des liquides médicamenteux*, was constructed by Charrière, of Paris, in three forms, all based on the same principle, viz. by the force of a compression pump the medicated fluid is driven in a fine capillary jet out of an exceedingly small aperture of exit with great violence against a metallic plate, and thereby pulverised into a fine spray.

The first form (fig. 2) consists of a metal vessel containing about 500 to 600 grammes of fluid, two-thirds of which is filled with the fluid to be pulverised. By means of an air pump air, in a given quantity, is compressed into the receiver, so that the contained fluid is submitted to a pressure which can be read off on the scale of a manometer. By a pressure of three to four atmospheres the fluid is then forced into a tube which passes upwards from the bottom of the receiver, and which, by means of a stopcock, can be closed until the pressure in it has reached the registered point; but before it reaches the stopcock

the tube opens into a cavity which is closed by the conical end of a metallic plug inserted into it so that only a small short canal, tapering to a capillary extremity formed by a corresponding groove in the metal cone, remains. Thus the capillary jet of fluid, driven by the whole force of the pressure in operation,

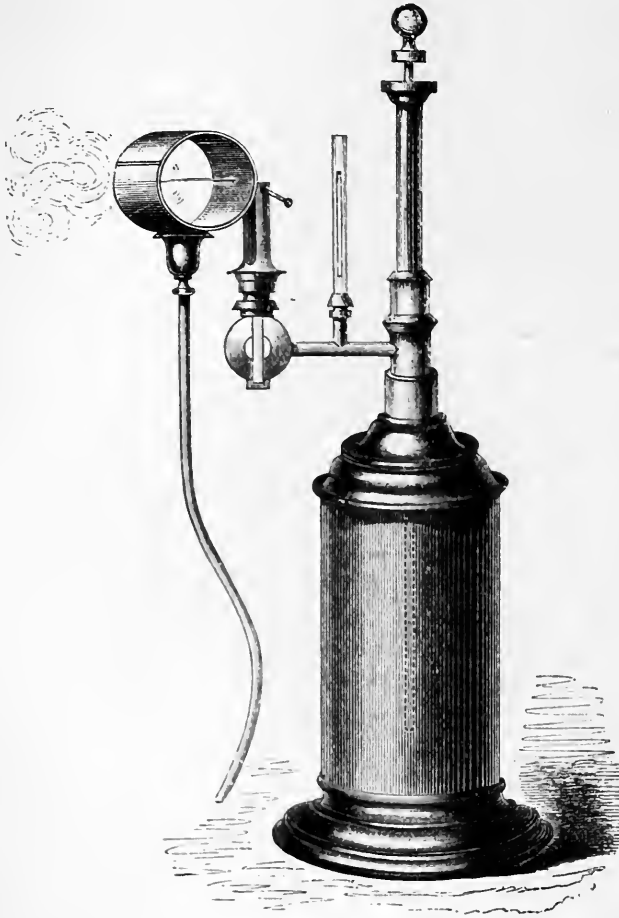

FIG. 2.

spurts out of the aperture of the inserted cone, and is forced against a metal disc, which lies in the concavity of a hollow cylinder, the so-called drum, in which there is also a corresponding aperture for the outflowing jet. The pulverised fluid



streams out of the aperture of the drum in the form of a dense cloud, which the patient inhales by holding his mouth in front of it, while the superfluous fluid runs off through a tube into a vessel placed below.

The second form differs from the first chiefly in that the receiver is made of glass, while the inserted piece containing the capillary tube still consists of metal, so that the apparatus is as little adapted as the first for the pulverisation of such salts as chloride of iron, solution of oxide of silver in nitric acid, &c.

In the third form water pressure is employed for the compression of the fluid by pumping the medicated solution into the apparatus, and, as the pressure under which the water is thus placed very rapidly diminishes, the pumping must be continued as long as the inhalation itself lasts. As the expenditure of strength necessary for this is very slight, the apparatus can easily be set in activity by the patient himself.

Sales-Girons' principle is also adopted in the admirable glass apparatus, which afterwards came much into use, constructed by Lewin (fig. 3) jointly with Goldschmied in Berlin, as well as in the apparatus contrived by Waldenburg, in which, instead of the air pump made use of by Sales-Girons and Lewin, Meyer's uterus douche was employed for pumping. Also the small apparatus constructed by Schnitzler in the form of a hand syringe, in which the pulverisation takes place in the oral cavity of the patient himself, acts on the same principle. A series of apparatus with various slight modifications have been introduced by Fournier, Baumgärtner, Brehmer, Schönecker, and others.

Lüer with his syringe-like apparatus, in which the piston is set in motion by the action of a screw, produces pulverisation by making two fine jets of fluid rush out under high pressure in such a direction that they come into collision with one another and are resolved into fine spray. Lüer has also constructed such a pulverising apparatus in the form of a hand syringe. Neither of these have been extensively used.

We may also mention here Sales-Girons' and Darwin's brush apparatus, used by the latter for pulverising dry powder, invented by the lithographer Niedermeyer, of Ratisbon, for his own use. A wooden wheel, whose periphery is closely set with

brushes, in rotating rubs against a plane above it, also set with brushes, and pulverises the fluid intended for inhalation, which trickles down upon the wheel from a receptacle above, while an earthenware pipe serves to catch and conduct the spray. The pulverisation is, as Dr. Bopp has stated, and as I have convinced myself, exceedingly fine and very well adapted for inhalation;

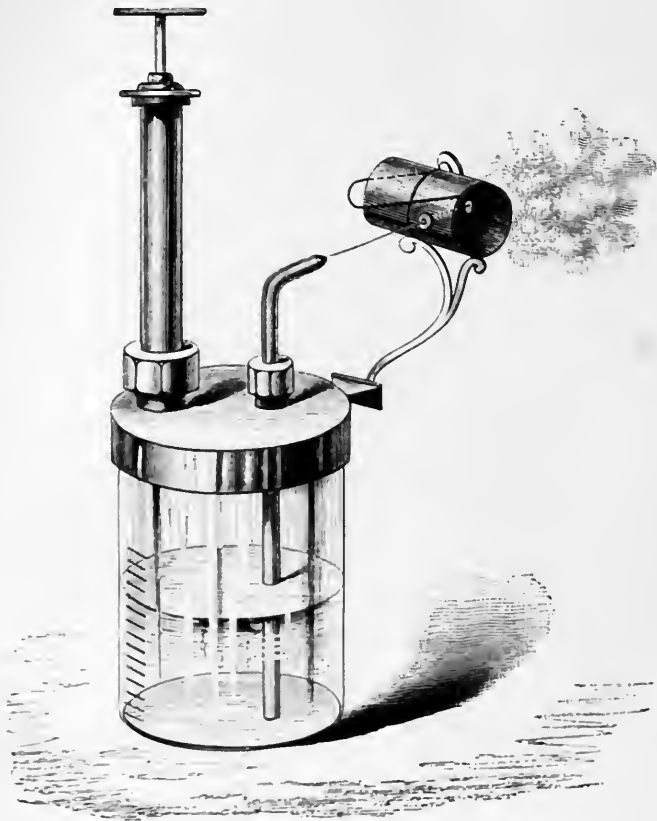

FIG. 3.

yet, on account of the difficulty of keeping the apparatus in order and other drawbacks, it has not found much acceptance in medical circles.

### 2. *Matthieu and Bergson's Apparatus.*

The pulverisation can be effected by the mixture of the fluid with compressed air in the following manner:—

1. The fluid is driven out of a capillary aperture at the same time as the compressed air, and

2. The fluid by means of the compressed air is driven out of another tube and thus pulverised.

(1) The original principle of the pulverisation of medicated fluids was conceived by Tiermann, and the first apparatus of this kind was constructed by Matthieu and called *nephogène* (fig 4). The capacious air receiver, provided with a suitable compression

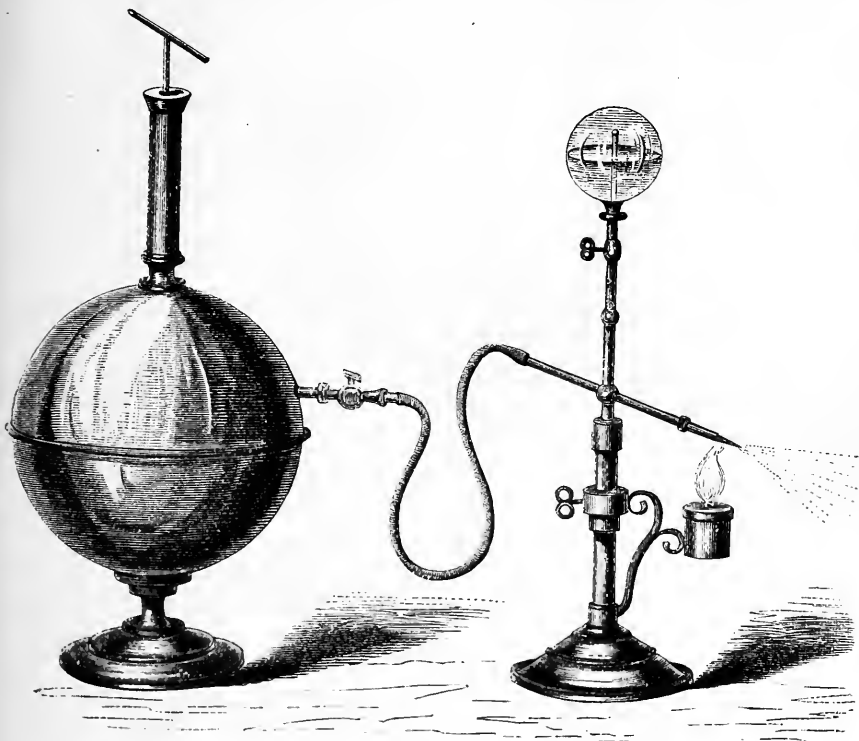

FIG. 4.

pump, is connected by means of a caoutchouc pipe with a horizontal canula, which opens on one side in the same direction into a very fine aperture of exit, in another direction communicates with a vertical tube extending upwards, opening into a glass sphere (a kind of heron ball), for the reception of the medicated fluids, and nearly reaching its upper part. The air receiver and the heron ball are furnished with stopcocks. When the air

in the receiver is sufficiently compressed and the stopcocks are opened, a portion of the outstreaming air pours into the vertical tube and passes in an upward direction into the heron ball, immediately heightening the pressure of the contained air and forcing the fluid down into the outflow pipe, where it meets the direct current of air and is immediately driven with it through the exceedingly small aperture with such violence that the jet of water is transformed into a cloud of fluid dust. By this kind of pulverisation the strongly projected cloud is mixed with a not altogether immaterial quantity of atmospheric air, which is conveyed with it into the respiratory organs of the patient, a mode of application which, in certain cases, may be of doubtful value or counterindicated.

(2) Bergson's hydroconion, constructed after a design of Natanson, at last provides us with a generally available, easily transportable, and cheap inhalatory apparatus, which, notwithstanding the many crude ideas and the construction of numerous forms of apparatus differing more or less from one another, has never before been available.

In its simplest form the hydroconion consists of two glass tubes connected with one another at a right angle; the ends standing opposite to one another are drawn out into fine points, and their capillary apertures so placed with regard to one another that the finer aperture of the vertical tube stands in front of the axis of the slightly wider aperture of the horizontal tube. The lower end of the vertical tube dips into a glass containing the fluid to be pulverised, a Wulf's flask, or a medicine phial, &c., while the other end of the horizontal tube communicates with bellows. When air is forced into the horizontal tube by means of the bellows, the current, as it passes over the capillary orifice of the vertical tube, draws up a part of the air out of it, thus forming a vacuum, which causes the fluid at once to rise into the lower end of the tube, till finally it reaches the orifice, and is blown by the current of air into a fine mist. In order to obtain a continuous equal stream it is better to use, instead of the simple bellows, an indiarubber bellows with which an air reservoir is connected. This may be worked by the patient himself, or better by an assistant. Bergson at first used a graduated Wulf's flask for the reception

of the medicated fluid, in one neck of which was a funnel for filling it, in the other the vertical tube of the hydroconion. It is needless to say that any other vessel will do as well.

Bergson's principle of aspiration and pulverisation is so simple, practical, and inexpensive that the apparatus at once won the widest acceptance. As all the parts of the apparatus are of glass it is available for every kind of respirable fluid, and the moderate price makes it possible to keep several supplementary tubes at hand, in case one gets broken or stopped up. The original instrument of Bergson has experienced but few modifications, and these of little importance.

Lewin has the two rectangular tubes made of metal and connected by a hinge, so that they fold together when not in use; one dips into the fluid to be pulverised, while the other is blown into. Everyone knows also the favourite *rafraîchisseurs*, which are used for diffusing perfumes. Wintrich prolonged the tubes into a beak-like form, to admit of the pulverisation of the fluid in the mouth of the patient.

Richardson's apparatus for the production of local anæsthesia is founded partly on Matthieu's, partly on Bergson's principle (fig. 5).

A moderately wide, slightly bent tube is fitted at one end into a cork which closes hermetically the flask that contains the fluid to be pulverised. The other end terminates in a blunt point, which is perforated by a fine aperture. Just above the cork the tube is connected with a horizontal branch, which communicates with bellows. A long fine tube is fitted in the axis of the main tube, so that at one end it reaches down to the bottom of the flask, and the other end, drawn out to an equally fine point, terminates immediately behind the aperture of the external tube.

When by means of the bellows air is pumped into the horizontal tube, a part of it streams downwards, presses upon the surface of the fluid, and drives it into the long, fine tube in the centre of the first one; another portion of the air, on the other hand, immediately forces its way outwards in the space between the two tubes, and, together with the jet of fluid streaming out of the inner tube, pours through the capillary aperture of the outer tube and drives it into a fine spray, as in Matthieu's and Bergson's apparatus. There is of course nothing to prevent

our using medicated solutions which can be conveyed by inhalation to the surface of the respiratory organs, instead of ether, chloroform, and other local anæsthetics.

### 3. Siegle's Apparatus.

*In this apparatus the fluid is aspirated and pulverised by steam instead of by compressed air, as in the apparatus already described.*



FIG. 5.

However simple and practical Bergson's apparatus was, almost completely superseding the former complicated and expensive ones, it yet possessed two disagreeable defects; one was that, in order to keep it working, the bellows had to be kept constantly in motion, and the other, which also appeared to be unavoidable in the other systems, that the pulverised fluid had generally to be inhaled greatly reduced in temperature, so

that it produced coughing and inflammatory symptoms, especially when mixed with compressed air. Bruns has attempted to meet the first inconvenience by connecting the Bergson hydroconion with a large compression pump; but this deprives the apparatus of all its simplicity and cheapness, and it would be a question whether Sales-Girons' apparatus or Lewin's glass apparatus, which is not complicated by the action of compressed air, might not be preferable.

Waldenburg was the first to find a practical remedy for the drawback attached to the other apparatus, viz. that of the low temperature of the pulverised fluid, by passing the steam of hot water from a retort through the drum, and so producing watery mist of sufficiently high temperature, which greatly enhanced the influence of the medicament upon the respiratory mucous membrane and the lungs.

By a happy suggestion Siegle has at last fully overcome the two deficiencies so often complained of, and devised an apparatus which surpasses all previous ones by the fineness of the pulverisation, by its automatic, continuous action, and by raising the pulverised mist to a suitable temperature, while its cost is far less than that of any of the larger apparatus previously in use, which it has now almost wholly superseded.

Instead of using compressed air by means of bellows to set Bergson's hydroconion into activity, Siegle tried to utilise steam for this purpose, so as to secure cheap and continuous motive power, while at the same time the heat of the vapour which was developed in the process could itself be turned to account.

Siegle's apparatus (fig. 6) consisted in its original form of a simple glass flask, tested to bear the pressure of two atmospheres, closed by a tight doubly perforated cork, in which was first inserted the horizontal tube of a Bergson's glass hydroconion, bent vertically downwards for this purpose, and then one of Collardeau's thermo-barometers for determining the temperature and pressure. The flask, which was afterwards replaced by a metal boiler, was enclosed within a tin case, and heated by a spirit lamp with a screw arrangement for the accurate regulation of the flame. Projecting from the outside of the tin case was a flat plate on which was placed a glass filled with medicated fluid, into which the vertical tube of Bergson's

hydroconion dipped. The glass flask or the boiler of the apparatus is half filled with pure water, as free from calcareous salts as possible (distilled or rain water is the best), in order to prevent as much as possible the deposit of boiler crust on the walls. The aspiration and pulverisation of the fluid takes place as soon as the pressure of half an atmosphere is reached, which is indicated by the cypher 2 and is accompanied with a peculiar

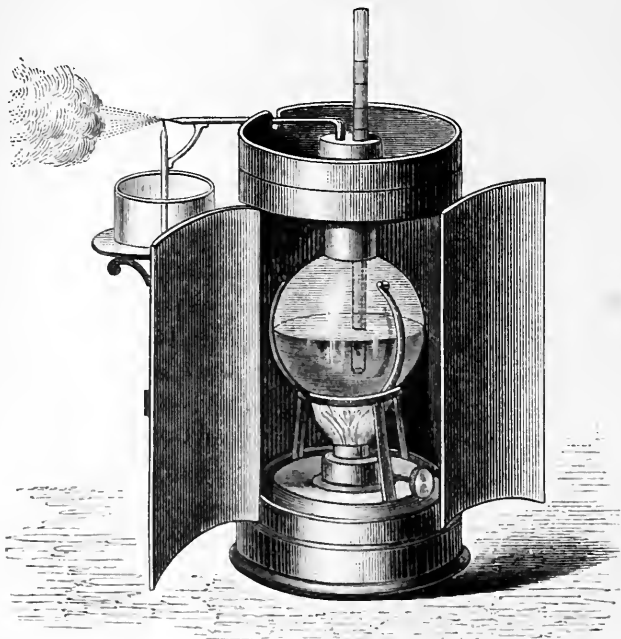

FIG. 6.

hissing sound. We can see, as the vapour pours out of the horizontal tube for some seconds, how the fluid begins to rise in the vertical tube, till it reaches the capillary aperture and is at once driven into the finest spray. The coarseness or fineness of the pulverisation of the fluid, and the rapidity with which the glass is emptied, depend on the size of the aperture of exit and the tension of the vapour.

Soon a variety of apparatus was constructed on the principle of Siegle's and Bergson's, some of which were only slight modifications of the original apparatus, and differed either as to the substance of which the boiler was constructed, whether of



glass, brass, or tin; or as to that of the pulverising tubes, of which either both or only the steam pipe was made of metal, generally brass; or as to the nature of the aperture or the kind of case in which the boiler was enclosed, also as to the situation and form of the tubes and the nature of the precautionary arrangements, whether spring valve, spherical valve, quick-silver manometer, &c. So numerous are the apparatus that have been devised that it is impossible to describe the individual modifications (by Lewin, Burow, B. Fränkel, &c.), but they vary greatly in quality, as speculative industry has taken a lively share in the business, so that suitably constructed and durable apparatus are after all not very easily obtained.

*Steam Pulverising Apparatus of Improved Construction.*

The various apparatus now offered by the trade, which are constructed on Siegle's principle, and are partly simplifications, partly improvements of the original apparatus, are not only of very unequal value, but some of them are not unattended with danger even in the hands of careful patients, as I have five times witnessed explosions, and sometimes severe scaldings, result from these cheap and ill-constructed machines. According to my experience (extending over seventeen years or thereabouts, during which this apparatus has been in vogue), it is necessary that we should look carefully to their construction, and it is by no means a matter of indifference as to what material they are made of, whether they are of one shape or another, and what has been done to ensure their safety.<sup>1</sup>

The reservoir of the apparatus in which the steam is generated must be a well-made metal boiler, not too small, so that the apparatus can be kept in activity for a sufficiently long time, and to avoid any escape of the water from the steam pipe in case of

<sup>1</sup> I have myself observed serious accidents arise from neglecting the caution given in the text to be careful to select a steam spray producer of proper construction and sound manufacture. A patient of mine was on one occasion using a cheap and badly made one sent him by the chemist, in which the horizontal tube was fitted horizontally into the boiler simply by a cork: this was blown out by the force of the steam while in use, and my patient's tongue, soft palate, and uvula were badly scalded.—TR.

over-filling. It is a matter of no consequence whether the boiler is of brass or tin, if only the parts are well soldered together.

The boiler in my apparatus (fig. 7) holds 200 grammes, and is filled half full of water. For the avoidance of explosions, especially when the aperture of exit of the steam pipe is stopped up, a simple, well-made valve, whose serviceability can easily be tested before each employment of the apparatus, is indispensably necessary. In my apparatus the

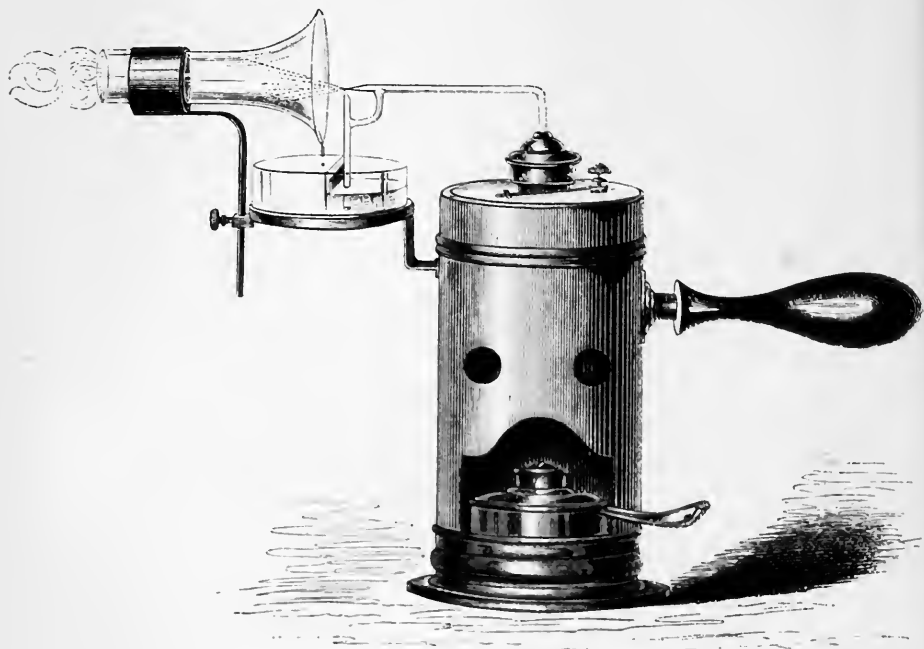

FIG. 7.<sup>1</sup>

aperture of the valve is closed by a steel spring about five centimetres long and one centimetre broad, which is fastened into a vice by means of an accurately fitting metal pin. By means of a wooden button covering the metal pin the valve can be easily opened and examined. When the spring gets out of order it is taken out of the vice, unscrewed from the metal pin, and replaced by a new one.

<sup>1</sup> To be obtained of Metzeler and Co., No. 8 Kaufinger Strasse, Munich, price 10 marks. Messrs. Squire, chemists, Oxford Street, have, at my request, imported some of Oertel's improved apparatus.—Tr.

The tubes, in which the fluid is pulverised, both the horizontal one, which conveys the steam, and the vertical aspiratory one, must be made of glass, as also the little bent arm which connects them, so that various chemical fluids, especially solutions of metallic salts, such as nitrate of silver, chloride of iron, &c., may not come into contact with metal and undergo decomposition and consequent contamination. The apertures of exit of these tubes also require great attention, the one for the vapour, and especially that for the aspired fluid. The size of these apertures has a direct influence on the size of the fluid particles and the degree of temperature; the narrower the aperture, the finer will be the spray, but also the lower its temperature. So also the size of the outflow aperture and the fineness of the pulverisation influence the quantity of the spray which is obtained, and which is the more abundant the larger is the outflow aperture. I use three kinds of tubes, one with the same narrow apertures that Siegle devised, which generate, a rather cool, exceedingly fine spray, admirably calculated for penetration into the final terminations of the bronchi and the air cells, but comparatively small in quantity. The second, a very convenient form with somewhat larger aperture, yields, when pretty strongly heated, large quantities of also a fine spray, which is capable of copiously irrigating the pharynx, larynx, trachea, and bronchi with fluid, and even of penetrating into the air cells. In tubes with still larger aperture, and with highly heated steam, a somewhat coarse pulverisation is obtained, which can, however, be advantageously utilised as a pharyngeal douche to irrigate the affected parts of the mucous membrane with larger quantities of fluid and with forcible impulse, and which to some extent has the same advantage as those claimed for Matthieu's and Bergson's apparatus.

To connect the tubes with the boiler, the posterior part of the horizontal steam pipe is bent downwards at a right angle and fitted hermetically into a caoutchouc plug, beyond which its lower end projects 3 to 4 mm.; a metallic covering serves to screw it into the somewhat wide aperture of the boiler.

The lateral insertion of the tube into the boiler, such as is seen in the small low-priced apparatus, in which the horizontal tube simply passes through a cork stopper or caoutchouc plug,

and the latter is stuck into a corresponding aperture of the boiler, is utterly to be condemned.<sup>1</sup> If small particles of the cork or caoutchouc stopper have come off and been carried by the steam or by any other means into the tube, they will, when the apparatus is set going, be drawn into the aperture of exit and stop it up. In this case a sudden, abrupt interruption occurs in the pulverisation, and the next moment the cork, together with the glass tube and a rush of condensed vapour and boiling water, are driven into the face, mouth, and throat of the patient, which, if the apparatus is too near, will be scalded. I have three times seen such an accident. But when the pipe conveying the steam bends down vertically into the boiler, then, even if the valve does not act or if there is none, the glass tube is simply projected upwards together with a rush of water and steam, without the smallest injury to the patient. Several such cases have come within my experience, in two of which the apparatus was completely shattered to pieces.

A useful practical addition to this apparatus is a cylindrical glass tube 3–4 centimetres wide, and about 10–15 centimetres long, with a wide funnel-shaped opening and a narrow outlet; this is placed in front of the outlet aperture of the steam pipe by means of a support, and can easily be removed in case of need. As the spray at its exit assumes a conical form, the apex being at the outlet aperture and the base rapidly widening, the constituent particles diverging further and farther from one another, and becoming more and more freely mixed with air, it is generally a decided advantage to be able to concentrate the spray by such an arrangement. Some of the spray of course precipitates itself in the form of fluid drops upon the walls of the tube, but the conical mass of spray is made to assume somewhat of a cylindrical form, and thus its tendency to rapid dispersion is diminished. The pulverised fluid can thus be conveyed directly into the mouth of the patient, and if he takes the end of the cylinder in his mouth the spray can be conducted directly to the parts affected at a tolerably high temperature (up to 40°–45° C.), whereas, on the other hand,

<sup>1</sup> Numbers of 'steam spray producers' of the cheap construction thus condemned by Oertel are supplied by chemists in this country, and it was with such an one that the accident happened I have already mentioned.—TR.

owing to the more cylindrical form which the denser concentrated mist is made to assume, it can be inhaled at somewhat greater distance, and therefore at a lower temperature, than when this plan is not adopted. The collection and concentration of the spray may be made still more complete by increasing the width of the funnel-shaped end of the tube, which has the further recommendation of protecting the patient's face from an unwelcome shower of the medicated spray. The glass cylinder may either be fastened to the apparatus by a support, or the patient, especially if he is obliged to remain in bed, can take it freely into his mouth, while a careful attendant keeps the apparatus at a suitable distance, and in the right direction in front of the funnel-shaped aperture. The fluid that condenses in the cylinder and flows out of it is either collected again in a vessel placed underneath, or the vessel containing the medicine is separated by a partition into two parts, one of which contains the solution to be pulverised, while the other receives the overflow from the cylinder. If we want as nearly as possible the whole mass of the spray to be inhaled, we must do away with this cylinder and bring the apparatus close in front of the widely opened mouth of the patient, whose oral and pharyngeal cavities through their funnel-like dilatation offer the most favourable condition for the entrance and the aspiration of the pulverised fluid. My apparatus has a movable support for the cylinder, working up and down by means of a screw.

The boiler with the pulverising tube should be enveloped in a metal case, or rather should be supported in a metal tube of sheet iron or brass, which is fastened to a somewhat heavy metal plate, and has an opening low down through which the spirit lamp can be introduced under the boiler. To the upper end of the tube on one side a metal plate is fitted, upon which the glass with the fluid to be pulverised is placed, while on the other side a wooden handle is screwed on, to hold the apparatus conveniently during inhalations, especially if the patient is obliged to lie in bed, and to enable it to be carried about. Such a metal case for the reception of the boiler is always preferable to the tripod so commonly used, as there is much less danger of the apparatus setting fire to anything than when

the spirit lamp is unprotected under the boiler, and the flame, which for the most part plays all round it, is much more apt to come into contact with combustible objects, especially in the vicinity of the bed. This protection will be still increased if there is a depression in the bottom of the metal case into which the spirit lamp fits, so that it cannot slip about or be overturned. A metal case also retains the heat better, and the apparatus is more rapidly heated.

Collardeau's thermo-barometer, which Siegle attached to his apparatus, does not appear to me of paramount necessity, as safety is sufficiently secured by the valve, which must in no case be dispensed with; the use of the thermo-barometer is also attended with this drawback, that the patient has to direct his attention to the rise and fall of the fine column of mercury, and cannot therefore pursue the inhalation with the desirable calmness. But where it is of scientific interest during the inhalation to observe at the same time the temperature of the vapours employed and to read off their tension, or when we want to avoid too high a temperature, and to use only the tension of the vapour which is necessary for pulverisation, it is needful to affix such an instrument to the apparatus. For this purpose we need only use a doubly perforated caoutchouc stopper, and have a somewhat larger upper aperture in the metal case into which it fits and by which it is screwed on to the boiler. The descending limb of the steam pipe will then pass through one opening of the caoutchouc stopper and the Collardeau's thermo-barometer through the other. Where expense is no object and the apparatus is in intelligent hands, a thermo-barometer may be included in its construction.

The modifications of which we have spoken in the construction of Siegle's apparatus have not arisen out of theoretical considerations, but from practical necessity; and they must always be kept in view in the choice of an apparatus, if we desire a thoroughly efficient one. They have, one or other of them, been generally recognised by the authors of the various apparatus as necessary, and adopted in practice.

As most patients require more than one or two applications of the inhalations in the day, and as they are not always able to leave their room or bed, it is better that the patient should

procure an apparatus for himself, rather than attend special inhalation chambers for the purpose, which, except in health resorts for the application of special remedies, are often not well looked after. The price of the apparatus is now so moderate that everyone, even those with very small means, can procure a serviceable apparatus, and when he has ceased to use it can pass it on to others.

#### DIFFERENCES IN THE WORKING OF THE DIFFERENT APPARATUS AND THEIR INDICATIONS.

##### *a. Differences.*

According to the differences in mechanical principle upon which the construction of the different apparatus is based, so their sphere of action will differ, and their therapeutic effect will be influenced by distinct physical differences.

These differences consist in the nature of the movement impressed on the several particles and the temperature at which the spray is produced. The first difference, which entirely determines the manner in which the fluid is introduced into the respiratory organs, depends on the motive power by which the different pulverising apparatus are set in activity, whereas the second, the temperature, is not only dependent on this, but also on the approximation of the temperature of the spray to that of the surrounding air, as well as on the refrigeration which it undergoes from the expansion of the aqueous vapour of the compressed air.

1. In the apparatus in which the pulverisation depends on the projection of a jet of fluid against a solid plate, such as that of Sales-Girons, the pulverised particles flow out of the drum, with only a very slight impetus onwards, and tend to sink slowly to the ground; they are easily carried away by the air in the form of delicate cloudlets, and follow the inspiratory current, by which they may be completely drawn in with the air in which they float. While a relatively large quantity of this inhaled mist is deposited in the pharynx and larynx, yet a considerable quantity penetrates into the trachea and the bronchi, and a part even into the final ramifications of the air passages, so that by the use of this apparatus a direct influence can be

exerted both on diseases of the more superficial and those of the deeper parts of the respiratory tract.

The temperature of the spray itself is at the same time essentially dependent on the temperature of the fluid employed, and on that of the surrounding air. If the former is only a little lower than the latter, the spray produced is only slightly cooler than the surrounding atmosphere. If the fluid has been first heated, the temperature of the spray will be above that of the air, but yet the temperature will be lower than that of the fluid. Finally, the temperature of the spray may also be considerably reduced by refrigeration of the fluid, and if the temperature of the fluid approaches freezing point the temperature of the spray will be about half of that of the room. The range of temperature, then, is very considerable, and may vary between about  $5^{\circ}$  and  $30^{\circ}$  C., according to the temperature of the fluid and of the atmosphere.

2. These conditions are less amenable to control when an apparatus like Matthieu and Bergson's is employed, in which the pulverisation is effected by mixture of the fluid with an outflowing current of compressed air. The propulsive power of this current imparts to the aqueous particles such a momentum, surrounding them and carrying them along, that they are scarcely at all diverted from their course by the inspiratory effort of a lung which may be in great part diseased, whereas in Sales-Girons' apparatus the independent movement given to the particles of pulverised fluid can be overcome by the inspiratory power of the lungs, and the spray follows the inspiratory current entirely; but in these apparatus the resultant of the impelling force of the apparatus and of the inspiratory force of the lungs is essentially fixed by the former only. If the spray be inhaled near its point of production, where it is dense and streaming out under a considerable force and perfectly horizontal in direction, the particles of fluid will almost all strike against the lining of the mouth and pharynx, and very little will be diverted out of the strong current of compressed air into the deeper respiratory passages. However, both by condensation and impact a fine steamy mist, thoroughly and equally mixed with the atmospheric air, will be formed, which is capable of penetrating with the inspired air into the deeper parts. More-



over, from the little drops which collect in the pharynx more or less fluid will flow down into the larynx, and moisten its mucous membrane.

Thus the apparatus constructed on the principle of Matthieu and Bergson act rather as insufflators, most of the fluid coming into contact only with the upper parts of the respiratory tract, the mouth and pharynx, less with the larynx and the trachea, while comparatively only a very small portion of the pulverised fluid penetrates into the bronchi and the lungs. Moreover, the violent impact of the compressed air may, in sensitive persons, cause some mechanical irritation in the glottis, bringing on coughing and a sensation of dyspnoea in patients who suffer from shortness of breath.

With regard to the temperature of the spray, it is also greatly influenced by the stream of compressed air, and, according to the experiments of Demarquay and Poggiale, with which those of Waldenburg agree, it is several, perhaps 3, degrees cooler than that of the surrounding air, even when the fluid employed is very hot. This is due to the sudden expansion of the condensed air, abstracting heat (which becomes latent) from the water in contact with it. The temperature of the pulverised fluid is therefore limited to a very narrow range, and within these few degrees it seems either cool or cold.

3. The apparatus which are worked by means of steam present the most favourable conditions for the formation and the penetration of the fluid dust into the air passages, for not only do they reduce the medicinal fluids into an exceedingly fine powder, but the steam also combines with a part of the pulverised fluid and forms with it a kind of mist, which, on account of its elasticity, can penetrate even through long and narrow tubes.

And while the spray produced by the other apparatus deposits itself for the most part upon the walls of the upper air passages, especially the mouth and pharynx, or at most reaches the larynx, with these abundant quantities of the mixture of steam and pulverised fluid penetrate down into the trachea and the large bronchi, and at last reach the finest ramifications of the bronchi and the air cells.

The temperature of the spray when it is produced by steam

is considerably higher than that of the surrounding air, and, on account of its slight density, it does not fall to the ordinary temperature of the room till at a greater distance from its point of production than appears desirable for inhalation. If a short cylinder is connected with the pulverising tube, and if the patient keeps the free end of it in his mouth, a temperature as high as  $40^{\circ}$  to  $45^{\circ}$  C. can be attained in the oral cavity. At a distance of 5 to 10 or 15 centimetres from the aperture of exit the temperature still maintains a height of  $36^{\circ}$  or  $35^{\circ}$  to  $20^{\circ}$  C. when the ordinary temperature of the room is  $15^{\circ}$ . Siegle, whose apparatus possesses exceedingly small apertures of exit, and therefore generates less fluid dust than those of more recent construction, gives lower figures, and the temperature with his apparatus ranges from  $15^{\circ}$  to  $20^{\circ}$  C. for the ordinary distance.

From the physical differences which thus obtain in the different apparatus for the pulverisation of fluids, distinct principles may be deduced for their application, according to the nature and the seat of the disease in the respiratory tract.

Although Sales-Girons' apparatus, by the extent of its applicability, by the penetrating capacity of the spray it produces, and also because of its great range of temperature, may be used in the greater number of diseases of the respiratory organs, yet the apparatus constructed on his principle are now quite superseded and displaced by Siegle's apparatus, which is not only equally valuable, but in many ways acts more favourably and is far less expensive.

Thus in the treatment of diseases of the respiratory organs by the inhalation of medicinal fluids there are two kinds of apparatus employed of which we must take account: in one the spray is produced at a somewhat low temperature and is mixed with compressed air; in the other it is produced by steam and at a higher temperature. In selecting one of these apparatus we must remember that the extent of its application depends upon its mode of action.

#### *b. Indications.*

1. For the use of the apparatus in which the spray is generated by admixture of the fluid with a stream of compressed air.

Only in a limited number of diseases, chiefly of the mouth

and pharynx, a few affections of the larynx, and still fewer of the trachea and bronchi, should these apparatus be preferred to those constructed on Siegle's principle.

To this category we would refer especially erythematous and less generally phlegmonous inflammations in their initial stage, when accompanied by a sensation of heat, dryness and burning in the throat (angina, pharyngitis, &c.), as well as chronic pharyngeal and laryngeal catarrhs, when accompanied also with a sense of heat and dryness; in such cases the remedy acts more like a cold douche, and is at once felt by the patient as cooling and as alleviating irritation. In hæmorrhages also, whether proceeding from the upper or from the deeper parts of the respiratory tract, cold generally produces a favourable effect and is usually well borne. But a regular and uninterrupted working of the bellows and a sufficiently fine pulverisation of the fluid are indispensable conditions for their application. Waldenburg prefers these to the steam apparatus in cases of pulmonary hæmorrhage, but I have never witnessed any injurious results from the latter when they are judiciously used; when the spray is not inhaled too near and at too high a temperature. On the other hand, the cooler spray of the Bergson apparatus, if it reaches the bronchi, at once acquires the temperature of the air there and no longer exerts any influence by its low temperature.

## 2. Apparatus in which the fluid is pulverised by steam.

The steam pulverising apparatus is extensively employed in the treatment of diseases of the respiratory organs, on account of the greater abundance and fineness of the spray and its soothing warm temperature.

In almost all acute and subacute catarrhal processes, in chronic catarrhs and their acute exacerbations, in croup and diphtheria, in most cases of phthisis, and in emphysematous patients, who frequently react vigorously to the influence of low degrees of temperature, its mode of action and the development of heat which takes place in it is not only useful, but necessary for the desired result. In treating many other diseases temperature is not a necessary condition, but even in such this kind of apparatus may be preferable to the others because of its usefulness and handiness; and in cases where a low temperature

is desirable, as in pulmonary hæmorrhages, as above mentioned, they are perfectly suitable, if they are only placed at a due distance from the patient, and are not too strongly heated, so that the temperature of the spray does not exceed 28° C. I have found them very serviceable in a great number of cases of hæmoptysis, in which the hæmorrhage was copious and difficult to arrest.

Lastly, as regards their usefulness, so abundant is the spray that not only the pharynx and larynx are amply bathed with medicated fluid, but, owing to the thorough mixture of the pulverised fluid with the steam, by taking deep inhalations it can be carried into the final ramifications of the bronchi and into the air cells, and be absorbed there and exert its influence on diseases of these organs.

## II. APPARATUS FOR THE DEVELOPMENT AND INHALATION OF VAPOURS.

Before the construction of the steam spray-producing apparatus the search for an instrument by which the inhalation of warm vapours could be conducted with precision had much more interest than now. All the different classes of inhalations—simple warm vapours, the vapours of emollient and aromatic vegetable infusions, the combination of these with the vapours of ethereal or balsamo-resinous substances—can be best applied by the steam spray-producing apparatus, and it is only when such is not at our disposal, that we fall back on the other kinds of apparatus. The apparatus coming under this head usually consist of two parts—a receiver, in which the vapour is generated, which may be made of glass, earthenware, or metal, and a tube for the conveyance of the vapours which may issue either free or combined with atmospheric air by means of another arrangement, and in this way they may be applied for therapeutic purposes.

The apparatus used for dry fumigations, as well as those for the production of vapours from infusions and decoctions, may be arranged, according to their construction and the manner of their employment, into two groups, one in which the vapours issue free out of a single tube, and the other in which, besides

the outflow tube, which is connected with the mouth of the patient by means of a gum-elastic tube, a second tube is fixed into the apparatus for the admission of atmospheric air, which mixes with the vapour in the apparatus itself, cools it, and forms a sort of mist, which is inhaled by the patient by means of a mouthpiece.

The oldest kind of apparatus was modelled on that of Hippocrates, which, as already mentioned, consisted of a pot with a perforated lid, through which passed a reed pipe. In this case the vapours were inhaled with the open mouth, while wet sponges protected the parts round the mouth from the heat. Galen mentions a curious modification of this by Archigenes, viz. that the patient should place in his mouth an egg open at both ends to protect it from the action of the hot vapours.

This simple arrangement of Hippocrates may still be commended as excellent in principle, both for the development of dry fumigations and for the production of vapours from water and infusions. A common, tolerably wide-mouthed earthenware pot, capable of holding about 1 litre of liquid, answers the purpose. This is provided with a rather large, well-fitting funnel-shaped tube of metal, glass, porcelain, or pasteboard, which is fitted so that the tube is directed upwards, and serves for the passage of the vapours, while a damp cloth, laid round the edge of the pot and funnel, securely closes it. The vapours generated in this apparatus issue at once out of the funnel-shaped tube, and the patient can either inhale them directly, if their temperature is not too high, by taking the orifice of the tube in his mouth and placing his lips air-tight round it, or he can let the vapours pour freely out of the tube, bringing his open mouth to a greater or less distance from the orifice, and by taking deep inspirations inhale them mixed with atmospheric air. When only slightly heated the patient can place the tube in his mouth, kept wide open, and thus inhale the vapours thoroughly mixed with air. The great advantage of this plan is that the patient can inhale the vapours directly, without previous preparation, and without the necessity of troublesome apparatus, and can continue the use of them as long as he likes, if the vapour is produced slowly by means of a *réchaud* or small spirit lamp.

Lastly, a patient may inhale the vapours coming off from a vessel containing steaming liquid by holding his head over the vessel, and having both head and vessel covered with a cloth to keep the steam in. The whole face is of course heated in this way, and when this is undesirable we cannot recommend this method. But in many cases this kind of vapour bath may even be beneficial and contribute to the desired effect. A simple practical apparatus has been invented by Waldenburg. A simple retort with *tubulure* serves for the reception of the fluid; it rests on a stand, and the neck is connected by means of a



FIG. 8.

leather tube with a short cylinder, which allows the air to enter freely all round the mouthpiece of the leather pipe.

Many forms of apparatus exist, composed of metal, earthenware, china, or glass, to meet the second mode of application of vapours, in which the patient, by means of a mouthpiece which he takes between his lips, inhales the vapours or the mists developed from them. Mandl's apparatus has obtained considerable popularity. It (fig. 8) consists of a glass globe capable of containing about 150 cubic centimetres, furnished with two tubes, one with a funnel-shaped orifice for filling it and

for admitting air; the other, with a somewhat broader rim, has a caoutchouc tube 12 millimetres in diameter and 30 to 35 centimetres in length fastened to it; to this, by means of a wooden connection, a second caoutchouc tube, 7 to 8 centimetres long, is joined, which the patient receives directly into his mouth in the place of a mouthpiece of wood, horn, &c. The glass globe rests, secured by two forked supports, on a suitable stand, and is heated by a spirit lamp sufficiently to cause the fluid to vapourise; boiling is not necessary.

Other apparatus differ only slightly from this, and from that

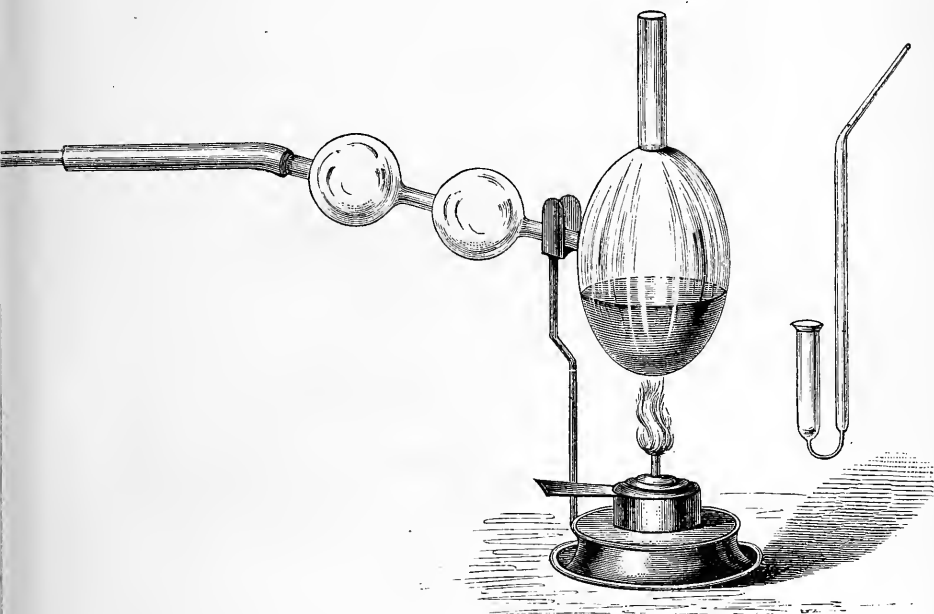

FIGS. 9 and 10.

of Mudge, formerly much used in practice. Lewin (fig. 9) has also invented an apparatus for the inhalation of medicinal substances, which is composed of three alembics. The principal alembic holds ordinary medicinal substances; the first receiver is for ethereal oils, which volatilise at high temperatures and can be carried along with the vapours passing over it. The second receiver is for substances which volatilise at very slight elevations of temperature. A drawback attending this otherwise

well-devised apparatus is that by the rapid cooling of the steam both the glass globes soon become filled with distilled water, and the inhalation is thus prematurely put an end to.

However practical these apparatus, now in general use, may appear, they are nevertheless attended by two drawbacks, which may considerably interfere with their beneficial effect. A patient inhaling by means of a mouthpiece very easily falls into the error of simply sucking the vapour into the mouth, as in tobacco-smoking, and blowing it out again; and as the mouth is partitioned off by the thick layer of the soft palate and the uvula at the root of the tongue from the rest of the air passages, not a particle of it reaches the lungs. With this kind of apparatus the patient must almost always practise inhalation beforehand, and learn to combine every suction movement with an inspiratory movement, as in the Turkish manner of smoking, especially when the vapour has first to be drawn through long and narrow tubes, generally a rapidly exhausting process for the patient. Then, on the other hand, all these apparatus have this fault in common, that the greater part of the mist formed from hot steam becomes cooled in its long passage, and is deposited on the walls of the tubes with which it comes into contact in fluid drops, and thus is entirely lost for inhalation. If, then, we continue to use apparatus with mouthpieces for the inhalation of vapours and mists, it is absolutely necessary to select wide tubes, not less than 12 to 15 millimetres in diameter, as in Mandl's apparatus, and to combine with them correspondingly wide mouthpieces, if the whole result of these inhalations is not to be illusory.

For the inhalation of vapours which are given off at a low or moderate temperature, such as those of the different ethers, chloroform, ethereal oils, turpentine, tar, creosote, carbolic acid, iodine, iodic ether, chlorine, we may employ an apparatus which consists of a double-mouthed receiver, one mouth serving to let in the air, while the other is connected with a tube having a mouthpiece. With very volatile substances, as the various ethers, a small apparatus like the top of a tobacco pipe, made of glass or earthenware (fig. 10), in which is placed some cotton wool saturated with the substance, does very well. If it is necessary to warm the substance before it gives off vapours, we must adopt



a somewhat complicated arrangement, or make use of one or other kind of the apparatus for inhalation, and let the ethereal oil be inhaled from it, mixed with aqueous vapours. The vapours of volatile substances can be evolved in greater quantities, or chlorine can be liberated from the aqua chlori, by passing through the cork which closes the mouth of the receiver which admits the air a second glass tube deep into the fluid, thus letting larger quantities of air pass through at every inspiration (Cannal, Cottereau, Corrigan, Maddock, Snow, &c.)

Fluids which vapourise freely even at ordinary temperatures may be simply sprinkled upon some cotton wool placed in a small flask with a wide mouth, from which the patient can inspire the vapour through the nostrils or the open mouth.

#### MEDICATED RESPIRATORS FOR PERMANENT INHALATION.

During the last twenty years various methods and apparatus have come into vogue with the object of bringing vapours of readily volatilised substances into prolonged and continuous operation.

Sales-Girons (1860), who considers oxygen specially dangerous to phthisical subjects; attempts to reduce its mischievous effect by making the patient inhale frequently in the course of the day and for several hours at a time an atmosphere impregnated with the vapour of tar through the medium of the tar respirator which he invented. This tar respirator differs from the ordinary respirator only in this particular, that it contains within it a receptacle for the admission of tar.

Sales-Girons has termed the method by which gases, vapours, or fumes are inseparably mixed with the atmosphere in which the patient lives, either by evaporation of water, by fumigations, or by medicated respirators, and constantly inhaled by him, the 'Respiratory Regimen.' The beneficial effect of such continuous inhalations does not, however, necessarily depend on their containing any foreign substances, but may be produced by physical conditions of the otherwise normal air, as its temperature, barometric pressure, relative humidity, &c., which may protect the respiratory organs from hurtful influences; in contradistinction to respiratory therapeutics, which

is concerned in the direct application of medicinal substances to the respiratory organs.

In Germany M. Langenbeck (1861) was the first to construct a medicated respirator, which consists of a flattened globe of boxwood or ivory, formed of two halves which are screwed together and perforated behind and before by from six to nine small holes. In the interior of the respirator is placed the medicine, which, if fluid, is dropped on charpie, and if solid is wrapped up in gauze, and the globe, when closed, is introduced within the mouth of the patient.

Langenbeck employs a great variety of medicines to act locally on the lungs. Thus in hæmoptysis he ordered ice with strong-smelling tan and dilute acetic acid to be inhaled, and prescribed the same remedy and cod-liver oil in pulmonary tuberculosis. In severe catarrhs he found elder and chamomile flowers with a few drops of oil of aniseed useful for promoting expectoration. He also used the balsams of Peru and copaiba for catarrhs of the larynx and the trachea. In *febris nervosa stupida* he recommends the inhalations of ethereal oils, or small quantities of musk; ether and chloroform in spasmodic cough and in whooping cough; spirit of sulphuric ether and camphorated spirit of sulphuric ether and aromatic vinegar as cardiac stimulants and analeptics. He believes he has reduced fever by the inhalation of cold air, the air having been cooled by ice and acetic acid. Of much greater importance, however, than the local action of the remedies is, he considers, their influence on the general health, on the condition of the blood and on the nervous system, so that he regards the respiratory surface more as a medium for the administration of volatile medicinal agents.

Ollivier in 1871 introduced a respirator for the inhalation of carbolic acid in phthisis and putrid bronchitis. Sigg also constructed an apparatus consisting of two wire sieves fitting into one another for the inhalation of ethereal oils; he used in the treatment of bronchial catarrhs and in bronchorrhœa to employ this apparatus for the inhalation of equal parts of terebinthol, spirit of turpentine, oil of turpentine, and a 20 per cent. alcoholic solution of carbolic acid.

Curschmann's recently invented inhalation mask seems, however, to be best adapted to this purpose. It consists of a

suitably constructed leaden mask, the margin of which is surrounded by an inflatable caoutchouc ring, so as to fit airtight over nose and mouth. It is dome-shaped, the top of the dome having a circular orifice of 6 centimetres in diameter, covered with wirework, and forming the floor of a capsule about  $1\frac{1}{2}$  centimetres deep, which is closed by a wirework lid. The capsule contains a sponge which is moistened at pleasure with the medicine to be inhaled. As the mask is fastened over the mouth and nose the patient can inhale the medicated vapours for many hours together, and even through the greater part of the day and night the surface of his respiratory organs can

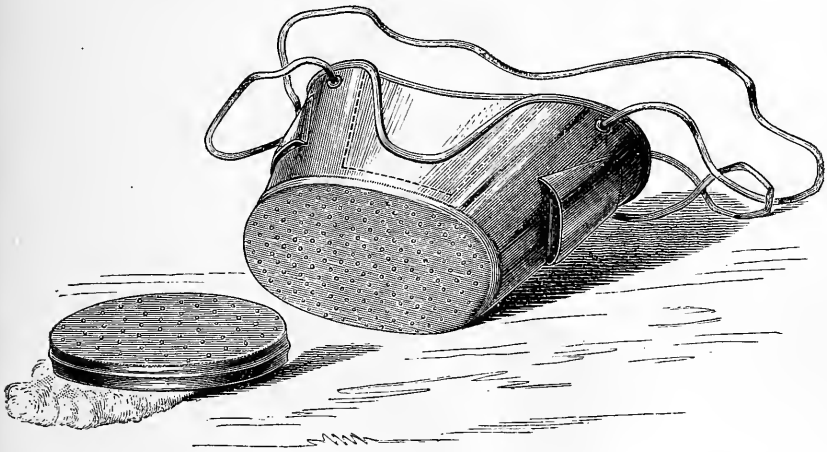

FIG. 11.

thus be brought under their influence. It was a good idea to keep patients, by means of such a contrivance, capable of various modification, for any length of time in a medicated atmosphere in which the medicinal agent is not so diluted as when it is simply allowed to evaporate in a closed room. Many attempts at treatment by inhalation have not been attended by any satisfactory results, because the quantity of the medicine employed and the duration of its application were not in due ratio to the intensity of the pathological processes with which we have had to deal.<sup>1</sup>

<sup>1</sup> This reflection of Oertel should be constantly borne in mind by all those who desire to realise what can be effected by means of inhalatory treatment.—TR.

A respirator suitable for the inhalation of medicated vapours has been invented by Hausmann.

The apparatus (fig. 11) is of conical shape, about  $4\frac{1}{2}$  to  $5\frac{1}{2}$  centimetres deep; its orifice measures 7 centimetres in its transverse and  $5\frac{1}{2}$  in its vertical diameter; a receiver consisting of a box with a perforated floor and movable perforated lid,  $5\frac{1}{2}$  and  $3\frac{1}{2}$  centimetres for the like diameters and 5–6 millimetres deep, is placed at the other end of the cone. At the upper part of the mouthpiece there is a piece cut out for the reception of the nose, so that the medicated vapours may be inhaled by the nose as well as the mouth. This opening can

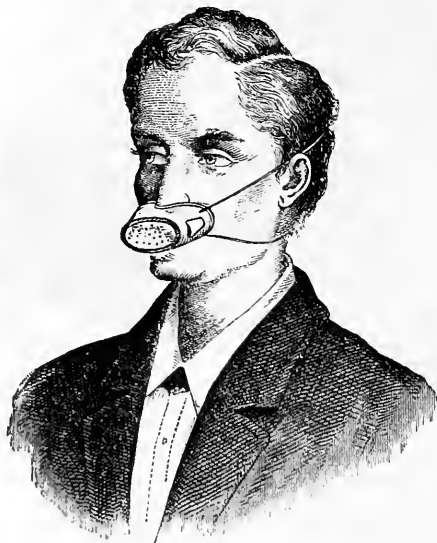

FIG. 12.

be closed by a small sliding metal plate, if inhalation through the nose is not desired. There are two valves on each side for the passage of the air in expiration.

This apparatus is decidedly preferable to Curschmann's, being lighter, more elegant in form, and more convenient and portable; on the other hand its receiver is smaller and shallower, so that it presents a less extensive surface and depth of cotton wool to the inspired air which passes through it, which is therefore less fully charged with medicated vapours than in Curschmann's apparatus. As Hausmann's apparatus does not

lie airtight upon the face of the patient, if a thick layer of cotton wool be placed in the receiver, a great part of the air in inspiration, instead of flowing through the receiver, will pass between the margin of the apparatus and the face of the patient, and thus, as a smaller proportion of the medicated vapour would be inhaled, the effect of the inhalation would be correspondingly weakened. Therefore in using Hausmann's apparatus it is desirable to employ a higher per cent. solution for inhalation than in the more voluminous apparatus of Curschmann.<sup>1</sup>

Dr. Feldbausch, of Strasburg, invented last year an apparatus for continuous inhalation through the nose only. It consists of two small tubes or capsules, each containing a small piece of blotting-paper or flannel, which are introduced into the nares, where they remain fixed of themselves. Feldbausch has had the apparatus constructed in three different large forms (fig. 13).

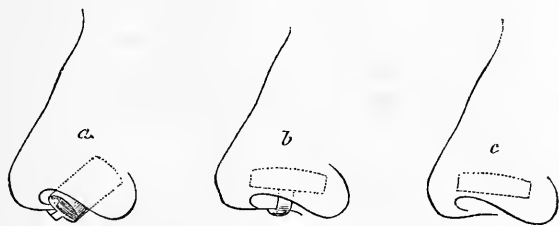

FIG. 13.

The first form consists of two small tubes connected with one another, and fixing in the nose so that it can only be seen in part from outside and does not disfigure the face. Its action is stronger than that of the two other forms, owing to the larger surface of blotting-paper it presents for evaporation. It is also far more handy, as it can be rapidly withdrawn from the nose in case of sneezing from snuff-taking, or in case of an increased amount of secretion. The second smaller form is hardly visible at all externally, as only a part of the narrow connecting piece can be seen, while in the third form the tubes are completely inserted into the nares, and so are altogether

<sup>1</sup> I have described in my '*Lectures on Consumption*' an 'inhalation respirator' which can easily be made by anyone, and which answers perfectly for continuous inhalations of readily volatilised medicinal agents. It is now extensively used, and is light, porous, and inexpensive. It is made by some of the London chemists and sold at prices varying from 3*d.* to 1*s.*—TR.

invisible. The effect of the two last forms is, as Feldbausch himself states, feeble, owing to the limited surface they expose for evaporation, but their effect may be increased by more frequent renewal of the medicament.

A dropping-tube is used for filling the apparatus with medicated fluid. By means of this tube you drop the prescribed number of drops on the blotting-paper, taking care not to wet the outside of the tubes or capsules, and not to saturate the blotting-paper too copiously; otherwise fluid may trickle from it, or in strong inspirations the liquid may find its way into the nasal cavity. When the apparatus is filled the patient introduces it into his nose, and inhales through it for the prescribed time. He should be instructed to take frequent deep inspirations during this process. The frequency with which the medicament is renewed will of course depend on its properties and the special nature of the case. Of substances which volatilise slowly, like carbolic acid or creosote, the former of which Feldbausch preferred, two to four drops are usually sufficient for an hour or more's inhalation, and if the blotting-paper is somewhat more copiously saturated the apparatus may be used the whole night through without renewal.

Convenient as this apparatus is, it is much too small, however, to give off vapour enough to act effectively in local affections of the larynx, trachea, bronchi, or lungs, especially when we have to deal with putrefactive processes; while, in the use of concentrated solutions, it does not protect the adjacent mucous membrane from their corrosive action. It may, however, be very successfully used in diseases of the nose, where the object is to act upon a small portion of the adjacent mucous membrane. The possibility of keeping the apparatus out of sight must not influence us too much in its favour.

Finally, Feldbausch recommends his apparatus for prophylactic purposes, as a protection for those who are necessarily exposed to infective atmospheres. Where it is necessary to keep out infective particles or render them harmless, these capsules are certainly to be preferred to the mask, as they can scarcely be seen and do not interfere with conversation. How far this suggestion of Feldbausch's, which really deserves every consideration, is practicable and likely to be successful must be

decided by future observations. I would earnestly recommend experiments in this direction.

Of the various antiseptic, disinfecting, narcotic, stimulating, and alterative substances which readily volatilise either pure or in solution we can recommend the following for continuous inhalation by means of the medicated respirator: ether, ammonia, amyl nitrite, aq. amygdalar. amar., aq. chlori, benzol, bromine, camphor, carbolic acid, chloroform, iodine, iodoform, creosote, ol. cadinum, ol. eucalypti, ol. junip., ol. pini pumilion. et silvestr., ol. rusci, ol. salviæ, ol. terebinth., thymol, ol. valerianæ, balsam. copaiv., Peruv. et tolut., tar, &c. Many of these have already been largely used in this way.

### *Medicated Cigars.*

Lastly we may include under the head of inhalations of vapours from mouthpiece apparatus the use of medicated cigars for therapeutic purposes, partly for the direct inhalation of vapours given off during the burning of the cigars, partly for generating an atmosphere impregnated with those vapours. In the first case the patient must smoke in the Turkish fashion, an inspiratory effort following the suction movement; in the latter it is sufficient to smoke in the ordinary way, the patient inhaling the fumes of the volatilised medicament mixed with the surrounding air.

Additional apparatus for the inhalation of special remedies will be mentioned under the proper heads.

### III. APPARATUS FOR THE INHALATION OF GASES.

The apparatus used for the inhalation of gases, in order to ensure their penetration into the air passages in fixed and definite quantities, must be provided with a conduit tube connected with a mask or mouthpiece provided with a valve to regulate the flow of gas into it.

The gas may be contained in an ordinary gasometer, or in a bladder or bag, in an indiarubber globe or in gummed or oiled linen or silk bags. The outflow of gas from the gasometer is regulated by the pressure of the water that flows in, and from the other receptacles by pressure on them by means of weights.

Hauke has invented a very simple contrivance for inhaling gases, consisting of a large flask (like those in which oil of vitriol is stored), which serves as a receptacle for the gas, and having a tight-fitting cork perforated for the passage of two glass tubes, one of which is joined to the tube connected with the mouthpiece, and the other, bent into the form of a U, dips with its longer limb into a vessel of water. As the gas is withdrawn from the receptacle by aspiration its place is supplied by water flowing in through the U-shaped tube. The best apparatus we now possess for this purpose is the gasometer of Waldenburg and Schnitzler, which will be fully described hereafter; it leaves nothing to be desired for precision in the dose of gas employed, for constancy of pressure, and for the perfection of the mask and the valve.

Apparatus from which the gas has to be aspired by the patient, instead of flowing out from the receiver by steadily continued pressure, are less worthy of recommendation, because in this case also there is danger that the greater part of the gas may be only sucked into the mouth, as in imperfect inhalation of vapours by means of the mouthpiece apparatus, and little or none ever penetrate into the lungs. But if for some reason or other they have to be used the patient must be instructed how to use them, in the same way as in the inhalations of vapours out of those apparatus. Children, or adults who are much enfeebled by illness, or who are very ignorant, are not able to aspire gas out of these apparatus in an efficient manner, and in their case therefore we should always prefer apparatus in which the gas flows out under active pressure and is conveyed directly into the mouth of the patient, and for this purpose the mask answers best.

The mixture of gases which constitutes atmospheric air is specially adapted for inhalation when its physical and chemical properties are altered in some way so as to confer upon it special therapeutic qualities. Langenbeck's respirator, by which he made fever patients inhale cold air, refrigerated by ice and vinegar, and, as he stated, with the effect of reducing temperature in fever, had almost been forgotten when P. Niemeyer lately suggested an apparatus for the inhalation of air strongly refrigerated by ice in different forms of disease (fig. 14).



This apparatus,<sup>1</sup> designed for the use of one person, consists of a cylindrical leaden receiver  $\frac{1}{3}$  metre in height and twenty centimetres in diameter, with a double mantle filled with air and therefore a bad conductor of heat, and a boxwood inhaling piece, provided with apertures for each nostril and connected with one another by an elastic tube. By means of a valve in the metal tube connected with the caoutchouc pipe inhalation can only take place from the receiver, whereas expiration takes place into the outer air. A layer of cotton wool for filtration lies immediately under the lid of the receptacle, the knob of which has several perforations between it and a second sieve-



FIG. 14.

like cover. In the interior of the apparatus there is a perforated false bottom, through which the water from the melted ice trickles and is separated from the solid ice. From this lower part a metal tube passes upwards and outwards, to be connected with the caoutchouc pipe. Another opening at the lower part, closed with a cork, permits the withdrawal of the melted water accumulated there.

When the apparatus is to be used the interior is filled up to the top with lumps of ice about the size of an egg, which,

<sup>1</sup> To be ordered from the patentee, Stackfleth, Berlin, N. Lindower Strasse 15. Price 30 marks, including packing, &c.

owing to the double leaden mantle, lasts the greater part of a day.

Where a Niemeier's apparatus is not to be had a respirator for the inhalation of cold air may be constructed in another simple manner (fig. 15A).

It generally use for this purpose a wooden vessel like a wine cooler, 35 to 40 centimetres high and 25 centimetres broad, which has an aperture near the bottom which can be closed with a piston (*p*). In the vessel there is a grate (*r*), consisting of a perforated leaden plate having three supports about nine centimetres high, from which springs a tube forty-eight centimetres high and eighteen millimetres wide, bent at its

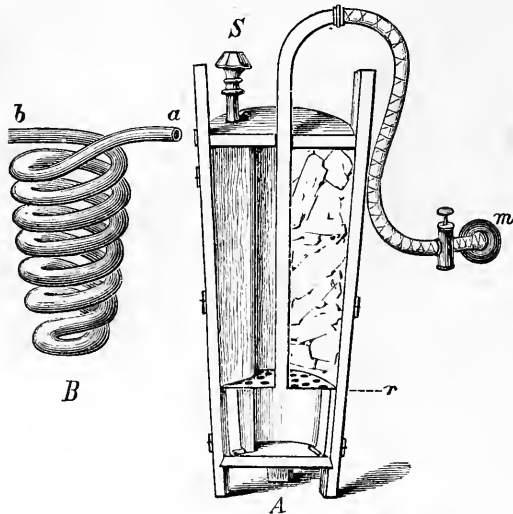

FIGS. 15A and 15B.

upper extremity. This is connected with a caoutchouc tube of the same width, having a mask to cover the mouth and nose (*m*) and a valve as in the apparatus of Schnitzler (vide, farther on, Schnitzler's pneumatic apparatus).

By means of the mask inhalations can be performed either through the nose or the mouth, according to the indications to be fulfilled. The wooden vessel is, as in Niemeier's apparatus, filled with pieces of ice as large as an egg (drawn in fig. 15 to the right) and closed above with a suitable lid. The air here

spreads over the surface of the pieces of ice, and becoming greatly cooled accumulates as heavy air below the grate, whence it is aspired and inhaled through the conduit tube. This wooden vessel should be placed in another wider vessel of wood, in order to collect and remove the water from the melting ice, and both should be placed on the ground before the patient for use. The piston (*p*) which works in a wooden tube affords a convenient means of letting the melted water escape.

A second simple contrivance (fig. 15B) consists of a double spirally twisted tube, which is also placed in a wine cooler or some other quite simple, sufficiently large wooden vessel, and is packed within and without with pieces of ice, till the vessel is full. The vessel, as well as the tube, is covered with a bad conductor of heat, and the melted water which accumulates, but which does not interfere so much with the process here as in other apparatus, is poured off from time to time. We can also make an opening in the side of the wooden vessel low down, which we can close with a stopper, and which will allow of the water being removed. For filtration of the air before inhalation some cotton wool can be placed in one end of the tube (*b*) enclosed in gauze and fastened outside by means of a string, to prevent its slipping down into the tube. On the other end (*a*) a caoutchouc tube about twenty mm. wide, with a suitable mask, may be fitted, or the end of the tube may be used directly for inhalation. The caoutchouc tube can even be used for nasal inhalations, if it is only wide enough, and a semilunar portion is cut away to admit the nose conveniently.

In using Niemeyer's apparatus the patient, lightly clothed, either seats himself in front of the apparatus placed on a table before him of a convenient height, and holds with one hand the terminal piece of the caoutchouc tube before his nose, or, if he is in bed, he lies flat on his back, while another person applies the nosepiece, or it is fastened with an elastic band round his head (Niemeyer).

A full and strong inspiration must be taken, the thorax being dilated gradually, till it is clear that the lungs are completely filled with air; then the patient must keep the thorax dilated as long as he possibly can without inconvenience to himself;

and when it becomes impossible to hold his breath longer he must allow the ribs to collapse, and expire quickly and strongly through the mouth.

As regards the time and the duration of the inhalations, Niemeyer directs that they should be used as frequently and as long as possible, till the feeling of exhaustion and of sleepiness which, especially with fever patients, sets in as a result of the cooling process, makes a pause desirable.

The more frequent and the deeper the inhalations, the more effectual will be the action of the cold air.

#### IV. APPARATUS FOR THE INHALATION OF SOLID SUBSTANCES.

At present the inhalation of remedies in the solid, pulverised state is scarcely ever practised. It has been completely superseded by the inhalation of pulverised medicinal solutions. Consequently no attempts have been made to devise new apparatus for this purpose, and a brief glance over this part of inhalatory mechanism will suffice.

The earliest apparatus for the introduction of pulverised substances into the air passages was the reed or the quill; with this the older physicians blew remedies of that kind into the air passages during an inspiration, or the patient introduced the reed or quill deep into his mouth, and then, by a vigorous inhalation, the nose being closed, aspired the powder contained in it into the larynx and trachea. Ebert, of Berlin, fills the hollow of a steel pen with the pulverised substance, such, for example, as a mixture of 0·15 nitrate of silver and 3·5 sugar of milk, &c., and plunges this for about half its length into one end of a quill open at both ends; then he introduces the quill deep into the mouth of the patient, so that the steel pen comes to rest on the root of the tongue; then he makes the patient shut his lips tight round the quill, closes his nose, and directs him to inspire rapidly and strongly through the quill. Though the first attempt generally fails with all patients, yet, as a rule, the second or third attempt immediately following succeeds more or less completely, and fits of coughing with tickling in the larynx coming on directly after show that a portion of the substance has penetrated into the interior of the larynx. It is

needless to say that in applying medicines in this way to the laryngeal and tracheal mucous membrane precision of treatment is out of the question, and that the amount of the substance applied, as well as the place to which it is applied, are only determined by chance. This mode of treatment, therefore, could only be justified at a time when there were no other means of subjecting the affected parts to local applications.

Darwin has invented a more complicated contrivance for the inhalation of substances in powder. He produces an atmosphere of dust in a box about 10" high and 8" broad by means of a rotating brush, whose bristles dip on one side into the powder to be diffused, and in rotating rub on the other side against an iron cross-bar, thereby producing thick clouds of dust. At the upper part of the box there is a funnel-like aperture or mouth-piece, whence the dust can be inhaled, while at the lower part there is a second opening for the entrance of air. This is identical in principle with the wheel which Sales-Girons subsequently used for pulverising medicated fluids; and the lithographer Niedermayer, of Ratisbon, independently adopted the same principle in the apparatus which he constructed for his own use.

Lewin used tubulated retorts for the inhalation of powdered charcoal, especially to demonstrate its penetration by means of the laryngoscope; through the tubulure of the retort a tube was passed, which reached to the charcoal lying at the bottom of the retort. One or more inspirations at the anterior extremity of the retort tube sufficed to inhale a sufficient quantity of charcoal for this purpose. I myself at an earlier period also employed a retort for producing an atmosphere richly charged with a medicinal powder, in which the glass tube dipping through the tubulure into the retort was connected at its upper end with a bladder, so that when this was slowly set in motion thick clouds of dust came out of the neck of the retort and could be inhaled with ease by the patient.

Lastly, experimenters used for the same purpose double-necked flasks, Wulf's flasks, wooden boxes, &c., into which two glass tubes were inserted, one of which reached down into the powder, for the entrance of the air and the blowing up of the dust, while the other was used for direct inhalation.

Nowadays this method of applying pulverised substances to the mucous membrane of the respiratory organs has completely passed away, and these remedies, when they seem indicated, are blown in by the physician himself through an insufflator, and this under guidance of the eye by means of the laryngoscope. For a more detailed exposition of this method we must refer to the sections treating of the laryngoscopic surgical treatment of affections of the larynx.

### MODES OF PRACTISING INHALATION.

If we would attain as far as possible the therapeutic effect which is the aim of medicinal inhalations, we must consider seriously not only the nature of the apparatus and the selection of the remedy, but also the mode of administering the inhalations which best correspond to the physical and anatomo-physiological conditions which they will encounter.

This, however, is dependent on the position and behaviour of the patient generally during the inhalation, also on the several parts of the respiratory tract being in the right position, as well as on the kind of respiration by which the fluid dust and the vapours are inhaled; the behaviour also of the patient before and after the inhalations will not be without influence on their action.

The most suitable time for inhalations both of vapours and of pulverised fluids is either before the principal meals or some time after them, when the stomach of the patient is not over-distended by a heavy meal and the depth of the inspirations thereby impeded. In feverish illnesses, such as diphtheria, &c., or where the number of inspirations is abnormally increased, these disturbances will be averted by the regimen appropriate to the malady. So, again, no inhalation should be attempted during or shortly after any great vascular disturbance or immediately after violent bodily exercise, and it should not be commenced till after a shorter or longer period of rest, when the vascular system is perfectly quieted.

During the inhalation the patient should avoid all bodily exertion, such as, for instance, working a pump to set the apparatus in motion, and he should not allow his attention to

be distracted by anything whatever from the regular carrying out of the inhalations. Therefore the patient should not be spoken to during the inhalatory process, nor should he take part in any ordinary recreations or be distracted by reading.

The fluid accumulating in the mouth, especially when it contains narcotic or other different substances, should be spit out into a vessel standing near, and only swallowed when its general effect through absorption by the digestive organ is also aimed at. At the close of the inhalation the patient may, if the treatment is not directed to the mucous membrane of the mouth and pharynx, remove the superfluous medicament from the mouth and pharynx by gargling with pure water; in the opposite case this will of course be omitted, to allow the remedy a longer local action.

After the inhalations, especially if they are employed at a high temperature, the patient must remain some little time—ten to fifteen minutes—in his room, and abstain from speaking as much as possible. Further special directions and precautions, which are to be observed during the application of particular remedies or in the treatment of distinct pathological processes, will be fully discussed in their proper place.

The sitting position is the best which the patient can adopt during the inhalations, with his elbows resting on a support, so that he can bring his inspiratory muscles into powerful action; and the apparatus is placed opposite to him in such a manner that, if he does not receive the outflow aperture itself into his mouth, it should stand somewhat higher than this orifice. Lewin recommends the patient to keep the head somewhat bent back, not that the entrance to the larynx may become free, but that the mouth may be so placed with regard to the larynx that the fluid particles, as they describe a certain curve in falling into the oral cavity, may pass on in their course uninterrupted by the palate and the posterior wall of the pharynx, and without being condensed there.

When the patient is confined to his bed he can inhale either sitting up or placed sideways at the edge of the bed, and he may be either completely recumbent or raised somewhat and his arm supported. The apparatus is at the same time placed at a suitable distance from the patient's bed, or an

attendant holds it in front of him, while he himself either inhales the free vapour or takes the tube directly into his mouth, which may or may not be connected with the apparatus. In the latter case, when the cylindrical mouthpiece is not connected with the apparatus, an attendant must hold the apparatus steadily in such a position that the aperture through which the spray escapes shall be exactly opposite the centre of the wide funnel-shaped end of the mouthpiece, so that the cone of spray may pass directly along its axis, without striking against any part of its walls. If the object is only to make the pulverised spray and the vapour act upon the oral and pharyngeal mucous membrane, as in diphtheria, &c., the inhalations may be continued during the sleep of the patient, and kept up for a long time, the patient lying at the edge of the bed, with the glass cylinder passed far into his mouth, while an attendant carefully holds the outflow aperture of the apparatus opposite the centre of the funnel-shaped orifice of the cylinder. As the object in such cases is only the action of the hot vapours and irrigation of the affected parts with disinfecting fluids, of course deep inspirations are not necessary, and the simple, superficial breathing of the sleeper is sufficient, as the disinfecting fluid will of itself be driven by the current of steam in sufficient quantity to the place where it is required.

In the case of grown-up children it is best to take them on the lap during the inhalations, the end of a somewhat narrower tube being placed or held in the open mouth. To dissipate the fear and dislike which we may encounter at starting we should ourselves first inhale before them, and repeat it from time to time. I have always by calmness and patience gained my point even with young self-willed children.

The position of the several parts of the respiratory tract must depend essentially upon whether we wish to act upon its upper or lower part.

If the disease is limited to the oral and pharyngeal cavity, it is sufficient if the axis of these cavities coincides with that of the column of spray or vapour, without paying any regard to the position of the deeper-seated parts. The patient holds his mouth wide open opposite to the apparatus, or takes the small end of the cylinder itself into his mouth, while the



tongue lies in the floor of the mouth or is pressed backwards, its tip touching the posterior surface of the lower row of teeth. The medicated fluid will be driven directly upon and completely irrigate the affected parts by the steam flowing out under a pressure of a half to three-quarters of an atmosphere. It will be necessary sometimes, but not often, to keep the back of the tongue down with a spatula.

The case is entirely different if we desire the pulverised fluid to reach the larynx at the same time. In this case it is necessary that the junction of the oral and pharyngeal with the pharyngeal and laryngeal cavity should occur not at a right angle, but at a very obtuse one, in order to facilitate the aspiration of the in-flowing spray, which, under the influence of the strong impelling force of the apparatus, can only be slightly diverted from its course when these join at a right angle. When the epiglottis lies deeply it may even be necessary to elevate it by drawing out the tongue and so uncovering the entrance to the larynx. Of course the technical method here described can only be put into practice when the opening of the mouth is not too much obstructed by the projected tongue, or when the isthmus of the fauces is not obstructed by its dorsum.

When, lastly, the medicated solutions are intended to reach the mucous membrane of the trachea and bronchi, and even into the air cells, the several parts of the respiratory tract must be placed so as to resemble a funnel-shaped tube, whose axis is a curved line which should correspond with the curve described by the falling clouds of spray, and which may be regarded as the resultant between the horizontal impulse given to the spray and the aspiratory power of the lungs.

The patient should then inhale, with his head somewhat bent back and his mouth wide open; and the tongue, according to the obstruction it causes, or according to the position of the epiglottis, must be kept either stretched out or lying as flat as possible in the floor of the mouth, its tip pressing against the lower incisor teeth. Only in isolated cases, when there is no other way of overcoming the difficulty, is it necessary to employ a spatula to keep the tongue down and maintain the pharyngeal cavity freely open.

The force of the respirations must also be proportional to

the extent of the respiratory tract and the distance of the parts we desire to act upon.

If our object is to treat only the oral cavity, the palate, the pharynx, or the surface of the epiglottis, we must direct the patient to take shallow inspirations, and to avoid deep ones as much as possible ; on the other hand, if we desire to act on the larynx and the trachea, and if we wish the particles of spray to penetrate into the terminal ramifications of the bronchi and into the air cells, we must cause the patient to make inspirations as deep and energetic as possible. If the patient is in a very weak state, the efforts attending deep inspirations must be avoided as much as possible, and only from time to time a deep inspiration be permitted ; it is, however, generally safer to be satisfied with the more superficial inspirations, even though a smaller quantity of fluid is thus introduced into the respiratory tract.

## NUMBER AND DURATION OF THE INHALATIONS.

### DOSES.

In whatever manner we bring medicinal agents in their various physical conditions in contact with parts of the respiratory tract by inhalation, we must always bear in mind that it is impossible in this method to separate healthy from diseased parts, and that the substances which are intended to produce a topical effect upon the diseased parts come also into contact with the parts which are healthy. And this is all the more necessary since the respiratory organs are very sensitive to the contact of foreign bodies, and when incautiously experimented upon manifest symptoms of irritation. Also the absorbent capacity of the mucous membrane is very considerable, and the rapid absorption of the inhaled substances into the blood favours in a high degree their general therapeutic effects, whenever they produce any.

It is clear that these special circumstances must be taken thoroughly into account in the carrying out treatment by inhalation, and must determine the choice and the dose of the remedies.

Strong, caustic remedies should never be used in such con-

concentrated solutions as to risk serious lesion of the mucous membrane or so as to act corrosively, and even in a diluted condition their inhalation will always require great caution, so that, while the strength of the solution is carefully adapted to the sensitiveness of the pharyngeal and laryngeal mucous membrane, it may not by deeper, incautious inhalations excite irritation in the lungs. The medicines and the degrees of their concentration must therefore be always so selected that they may be brought into contact with the healthy parts without injury, while they exercise a local therapeutic effect upon the pathological processes.

Substances whose general action on the organism is undesirable also require special attention in their application, and should be avoided altogether if they can be replaced by other remedies; in every case the quantity used in the application should not exceed the dose used when given internally, and in many cases it should be even less than that. Medicines whose local application offers no advantage over their internal or subcutaneous administration must usually be excluded, and remedies used for their general effect should only be selected if they produce more rapid and more favourable results when inhaled than when given in any other way.

The doses of remedies applied in the form of inhalations will, in contradistinction to their administration in any other way, be determined not only by the nature, intensity, and extent of the pathological changes, but also by the mode of application itself, dependent on the various constructions of the several apparatus for carrying it out.

(a) In Lewin's glass apparatus, constructed on Sales-Girons' principle, 60 grammes of fluid are pulverised in one minute with about 48 to 52 strokes of the pump; thus Lewin's apparatus pulverises at one sitting about a litre and a half in twenty-four minutes, and this is found to be about the most desirable quantity. Of this quantity, however, only about 90 grammes reach the mouth of the patient, and this amount must therefore contain the whole dose of the medicine which it is intended should come into contact with the mucous membrane of the pharynx, larynx, and bronchi.

(b) In Bergson's apparatus there is not so much waste as in those of Sales-Girons and of Lewin. Inhaled at the proper

distance, Lewin calculates that about  $\frac{3}{8}$  of the whole quantity of pulverised fluid finds its way into the mouth of the patient. This portion of the  $1\frac{1}{2}$  litre of fluid of his glass apparatus will correspond to about 240 grammes, which can be pulverised in about 12 to 14 minutes, if the aperture of the outflow pipe is proportionally wide.

(c) If the fluid is pulverised by steam, as in Siegle's process, then, according to the width of the aperture and the tension of the vapour, in about a quarter of an hour the apparatus will yield from 30 to 90 grammes of medicated spray, and if the patient takes the anterior orifice of the cylindrical mouthpiece into his mouth he will receive the greater portion of the fluid into that cavity, and, at a distance of 4 to 5 centimetres from it, about  $\frac{3}{4}$  to  $\frac{5}{8}$  of the whole, i.e. from 22 to 24 or from 66 to 72 grammes, will reach the mouth of the patient. In order, then, that about 90 grammes of fluid may come into contact with the mucous membrane of the pharynx, larynx, and bronchi, the patient must inhale for about twenty minutes, with outflow aperture and vapour tension equal to pulverising about 90 grammes of fluid in a quarter of an hour.

If we compare these calculations, which, it is needless to say, are only approximative, we require, in order to convey about 90 grammes of fluid into the respiratory organs, if we use—

(a) Sales-Girons' or Lewin's apparatus, 1,440 grammes of fluid and a period of 24 minutes ;

(b) Bergson's hydroconion, 240 grammes of fluid and 12 to 14 minutes ;

(c) The steam pulveriser, 120 to 150 grammes of fluid and 20 minutes.

In addition to this difference in quantity, which is unavoidable in the use of the different apparatus, we have to consider also the degree of concentration of the medicated fluid, which cannot be regarded as perfectly equal in the several apparatus.

If the medicated fluid be pulverised, as in Sales-Girons' apparatus, by impact against a disc of metal, or, as in Bergson's hydroconion, by compressed air, every particle possesses the degree of concentration of the original solution, and acts as such upon the mucous membrane with which it comes into contact. If, on the other hand, the pulverisation is effected by

steam, the steam becomes intimately mixed with the spray generated, and is deposited on cooling in the form of liquid drops upon the surface of the respiratory tract. In this process, however, the concentration of the solution is altered and attenuated exactly in proportion to the quantity of water evaporated in the pulverisation. In the apparatus constructed by Siegle for every 30 grammes of fluid pulverised some 25 grammes of water will be converted into vapour, and also in the more recently constructed apparatus on this principle an evaporation of 20 to 25 grammes of water is necessary for the same quantity of the medicated solution. These 20 to 25 grammes of water must naturally be taken into account in fixing the degree of concentration of the medicated fluid, and we must make it about  $\frac{2}{3}$  higher than in the case of the medicinal substances which are pulverised by Sales-Girons' or Bergson's apparatus.

The following account of remedial agents and estimate of their several relative quantities is based exclusively on the use of the steam spray, assuming a pulverisation of 30 grammes in 15 minutes, and that  $\frac{3}{4}$  to  $\frac{4}{5}$  of this quantity finds its way into the mouth of the patient. In using other apparatus, therefore, a reduction of the maximum dose by two-thirds must be made, or as near this as possible.

Together with the degree of concentration of the medicated solutions we must necessarily consider the number of inhalations and the number and duration of the sittings, for they together give the complete dose of the medicine employed. The number and duration of the inhalations, as well as the degree of concentration of the fluids, must be determined by the nature and intensity of the pathological process, the vulnerability of the mucous membrane, and the sensitiveness of the individual; different prescriptions must be given for chronic and for acute diseases. It is difficult, however, in this place to lay down general rules, but more exact estimates will be adduced when we come to treat of the several pathological states.

As regards the number of daily sittings for inhalation, it will be decidedly necessary to place it higher than has hitherto been the case if the desired result is really to be attained, and this not only in acute but also in chronic diseases. In acute processes

the number of sittings should amount to from 2 to 4 up to 6 or 8, and they should be repeated hourly or half-hourly in the course of the day, or even through a part of the night, while in subacute or even chronic cases seldom only 1 to 2, and much more frequently 4 to 6 or 8, and even a larger number of sittings must be ordered, if the obstinate processes are to be attacked with any good result.

The duration of the several sittings must also be measured by the sensitiveness and the powers of endurance of the patient, and should generally extend over 15 to 20 or 30 minutes; in the beginning the sittings may be somewhat abridged and limited to 5 or 10 minutes, afterwards either gradually prolonging them or increasing their number but lessening their duration.

During the sittings themselves the patient should be allowed to make more or less frequent, longer or shorter pauses, according to his strength. It is needless to say that in ordering medicated inhalations, in determining the number and duration of the sittings, as well as in the choice of the medicament and the determination of its degree of concentration, very much must be left to the discretion of the physician, and that no rules can be laid down beforehand to meet every case.

After these technical notices we have now to speak somewhat more particularly of the medicinal substances used in inhalatory therapeutics. We have classified them, as far as possible, according to the therapeutic action of the several substances, as well as with special regard to the mode of treatment under consideration, of which indeed they form the *materia medica*. Such a classification is all the more justifiable here because we are almost exclusively concerned with the local action of the substances in question; and the effects of the several drugs, according to the manner of their application and the possible degree of concentration of their solutions, do not diverge in the same manner as is the case with their internal application.

This plan seems the one best adapted for affording a scientific survey of therapeutic inhalents.

## REMEDIES ADAPTED FOR INHALATION.

### 1. REMEDIES WHICH WITHDRAW HEAT.

#### *a. Cold Air.*

*Mode of Action.*—Inhalations of air strongly refrigerated by ice will produce approximately the same effects upon the surface of the respiratory organs which cold also produces upon other parts directly accessible to it. The only difference will be that the influence is not so continuous and uninterrupted as in the application of cold in the form of ice compresses and ice bladders to the external surface, because for one thing the time devoted to inhalation is shorter, and also because, from the nature of the respiratory mechanism, alternating changes of temperature necessarily occur as the inspiratory current is cooled and the expiratory current is warmed, and this must of itself modify the effect of cold. On the other hand the amount of heat withdrawn by the cooled air will be proportionate to the depth of inspiration, in the same way as we found to be the case with the temperature of pulverised fluids. So also the farther the air penetrates into the respiratory organs, especially when it is inspired through the narrow posterior nares, whose mucous membrane is extremely vascular and has a very extensive surface, the more will the influence of the cold be diminished, till in the terminal ramifications of the bronchi and in the air cells of the lungs the air will be maintained at a more equable temperature, less influenced by the fluctuations of temperature caused by inspiration and expiration, but its temperature, however, will still be lower than that of the air of the lungs ordinarily is. Proportionally with the reduction of the temperature other physical properties of the air will also suffer change—namely, its density and its amount of moisture. Owing to the increased density of the inspired air, a larger amount of oxygen will, bulk for bulk, be conveyed to the respiratory organs than in the more heated air of the room, while the low absorption capacity of the strongly refrigerated air for aqueous vapours, which is still further reduced when the inspired air first passes through or over water and becomes charged with

moisture, will diminish the vaporisation of water from the surface of the lungs.

According to these conclusions we shall by inhalations of strongly refrigerated air—

1. Withdraw heat from the whole surface of the respiratory tract and from the lungs, and the degree of the cooling will be in inverse proportion to the depth to which the air penetrates. But as the depth increases the transverse section of the air passages—i.e. the surface which experiences the cooling process, the whole of the bronchial mucous membrane and the superficies of the lungs—increases also in a very remarkable manner, so that considerable lowering of temperature will be produced in spite of the heating of the air as it passes over the upper parts. This cooling influence will also be considerably promoted by the superficial position of the capillaries in the wall of the alveoli, which are only separated by a thin epithelial stratum from the air in the air cells, so that of all the vascular regions of the body they are the least protected from loss of heat by non-conducting tissues.

We can thus produce an antiphlogistic effect by withdrawing heat, not only in cases in which the temperature of special portions of the respiratory tract is heightened by inflammatory processes, but also in cases of fever with general rise of temperature, and, according to Langenbeck and P. Niemeyer, we are thus able to cool the whole mass of the blood and reduce the fever temperature. Niemeyer states that about twenty deep inspirations from the respirator and retention of the breath for a few seconds will be sufficient to lower the bodily temperature, taken in the axilla, by several degrees.

2. The breathing of air at a very low temperature, just in the same manner as cold applied to the external surface of the body, excites the contractility of the vessels, and thus by the diminution of their calibre lessens the flow of blood into the vascular region immediately exposed to its influence; it therefore tends to reduce the hyperæmia of the congested surfaces of the mucous membrane. The anti-hyperæmic effect due to the inhalation of cold air diminishes in proportion to the increasing warmth and surface extension of the deeper parts. If any styptic action can be attributed to these inhala-



tions, it can only be in the case of small capillary hæmorrhages in the upper vascular regions of the respiratory tract, as the cold no longer acts with sufficient intensity upon the bronchial and pulmonary surface to stimulate the ruptured vessels to energetic contraction; but certainly such inhalations, carefully administered, will act more favourably than the inspiration of the over-heated, steamy air of the room, and tend to promote the closing of the vessels and the formation of a thrombus. The styptic effect of strongly refrigerated air cannot be aided by deep inspiration and retention of breath, owing to the rapid and notable rise of intra-thoracic pressure and the resulting pulmonary hyperæmia—a combination of influences calculated to produce the very reverse of what is intended, viz. a larger loss of blood or the re-opening of a provisionally closed vessel. At the same time there is no doubt that in cases in which hæmorrhages are to be feared, where there is a predisposition to them, inhalations of cold air may act prophylactically and counteract hyperæmic conditions which may become the source of renewed hæmorrhage.

3. Since the anti-hyperæmic action diminishes and impedes the passage of the fluid and the corpuscular elements of the blood out of the contracted vessels, it must necessarily exercise a limiting influence on secretion and transudation. For by lessening the supply of blood to the glandular organs of the mucous membrane its secretory activity will be diminished, and not only will serous transudation and infiltration be impeded, but also the formation and secretion of mucus and pus cells in catarrhal conditions of the respiratory mucous membrane.

4. As the density of the air is increased by refrigeration, so also the density of the contained oxygen must be increased, and therefore a greater amount of oxygen is conveyed to the lungs, and this is even further increased by the circumstance that the deeper and stronger inspirations expand the lung more completely and bring a larger extent of respiratory surface in contact with the air. By this increase in the pressure of the oxygen and in the amount of blood coming into contact with it a chemico-physiological effect on the processes of respiration and oxidation must be produced, and this again must exert a subordinate influence on the nutrition and blood-formation of the

patient. Moreover its value in inspiration is increased by the fact of its filtration and contact with fluid, by which it is cleansed from injurious admixtures. An actual disinfection, a complete arrest or temporary suspension of putrefying and decomposing action in septic, putrid, and gangrenous processes must not, however, be looked for from these inhalations. Cold, which certainly arrests fermentation and putrefaction, and checks and destroys the vegetative process of schistomycetes, does not act here in the degree necessary to reduce sufficiently the vital activity of the lower fungi on the surface of the respiratory mucous membrane or of the lungs, as this is constantly being warmed by the subjacent blood currents. Convincing proof of this is given by fermentation experiments at various low temperatures. In severe cases of diphtheria, where even the direct application of ice which the patient keeps in contact with the infected parts, by means of pieces of ice in the mouth and pharynx, fails to suspend the decomposing process, in putrid bronchitis, in bronchorrhœa, and in the decomposing processes in bronchiectatic dilatations and cavities, no result is obtained by inhalations of air, however strongly refrigerated. These inhalations only so far exercise a favourable influence in diseases attended with fermentative and decomposing processes that they by their cooling action, where it is necessary, withdraw heat and lessen hyperæmia, and also, owing to the purity of the inspired air, a fresh introduction of deleterious substances into the respiratory organs is averted, and any further aggravation of the processes of decomposition already present checked.

5. Lastly, cold air, by reason of its low degree of saturation for aqueous vapour, will be of considerable value in relieving the heat and dryness of the mucous membrane in febrile cases where there is a greatly increased evaporation of water from the surface of the respiratory organs. This will be especially felt when the air passes over melting ice and the surface of water, and becomes, for its degree of temperature, completely saturated with aqueous vapour. The elevation of the temperature and of moisture capacity which the air undergoes after its entrance into the lungs will never be sufficient to occasion loss of water approaching even in amount that which is caused by inspiration of the dry, warm, and over-heated air of a room.

*Indications.*—The chemico-physical effects produced by inhalations of cold air render their application useful in many cases.

1. In all hyperæmic conditions of the respiratory organs, more especially of the larynx and of the lungs, brought about by increased activity or over-strain of these organs, as in public speakers, singers, &c., or in other persons from various causes. The air inhaled exerts in these cases a cooling and refreshing influence upon the heated parts, and not only withdraws the heat by exciting the vessels to energetic contraction and diminishing the blood contents, but also averts the exudation and tumefaction of the affected organs which the hyperæmia may produce. The secondary inflammatory conditions and disturbances of nutrition gradually set up in these persons by oft-repeated injurious influences will thus be most effectually warded off, and the development of diseases, such as chronic laryngeal and bronchial catarrhs, relaxation of the vocal cords, &c., which may be regarded as professional diseases, will be delayed as long as possible.

2. In all acute inflammatory affections of the respiratory organs, in the upper as well as in the deeper parts, extending over small or large tracts, the heat-abstracting and hyperæmic action of inhalations of cold air will directly combat the inflammation, and be found of equal, if not of greater, value than other methods.

Among these affections must be included acute catarrhal inflammations of the respiratory mucous membrane generally, of the nose, the larynx, the trachea, and the bronchi, which tolerate the action of cold better than that of astringent fluids; so also the graver affections of the lungs, such as pneumonia and pleuro-pneumonia, ought theoretically to be benefited by the application of cold in the form of inhalations of cold air, and be favourably influenced by them objectively and subjectively. But we have no satisfactory observations on this point as yet. It is needless to say that, where these processes do not occur as substantive diseases, but are secondary to a deeper-lying affection—and all the diseases of this nature connected with pulmonary phthisis come under this category—inhalations of cold air are not counter-indicated; only the results will be less favourable.

3. It is only rational that in febrile diseases we should not only seek to produce a strongly refrigerating effect on the surface of the respiratory organs, but also try to reduce the general temperature, in the same way as by the action of cold baths, in which heat is rapidly given off through the skin. In all feverish ailments, especially in general infectious diseases, and acute exanthemata, attended with high temperature, a reduction of the temperature by inhalations of cold air may be attempted, in which case the influence of cold on the hyperæmic and inflammatory conditions of the respiratory organs in certain of these diseases may in itself arrest the development of dangerous complications. The anxiety lest the admission of cold air into the larynx and the lungs should aggravate instead of diminish the existing affections of the respiratory organs, or even, like other causes of chill, superinduce cough and catarrh, if these are not already present, is wholly unjustified and easily set aside by facts. The patient himself finds these inhalations cooling and refreshing, and they afford subjective alleviation in circumstances in which it cannot be obtained by any other means.

4. In connection with this effect of the inhalation of cold air in local and especially in feverish ailments, its slight capacity for moisture, dependent on its low degree of temperature, is of value, as it tends to diminish the increased evaporation of water from the surface of the respiratory organs caused by the fever, and so serves to maintain their normal amount of moisture. As the inhalations of cold air at once abstract heat, diminish hyperæmia, and check evaporation, they are perhaps more useful than any other means now at our command for reducing the heat, dryness, and hyperæmia caused by fever, and so alleviating the subjective sufferings. Filling the respiratory organs with cold air will be followed by the same results, and its application is indicated in local erythematous and inflammatory conditions attended with symptoms of heat, dryness, and smarting, such as erythematous and acute catarrhal inflammation of the nasal mucous membrane, of the mucous membrane of the oral and pharyngeal cavity, in catarrhal angina, &c. Cold inhalations also bring subjective relief to the patient in parenchymatous and phlegmonous inflammations of the tonsils, of the peritonsillary tissue, of the uvula, of the mucosa and submucosa of the oral and pharyngeal cavity,

as also in those cases, in which suppuration is not imminent, they, in alternate combination with the local application of ice, will further the resolution of the inflammation. If this does not succeed we must later on substitute heat for cold and hasten abscess-formation by the inhalation of warm emollient vapours. Also in the deeper regions of the respiratory tract, in the larynx, trachea, and bronchi, inhalations of strongly refrigerated air are found to act beneficially upon the patient, partly by its low temperature and partly by its slight capacity for moisture, and to ensure a speedy recovery either alone or with the aid of other measures.

5. The inhalation of cold air is decidedly useful in cases of respiratory insufficiency, on account of its greater density and consequently its greater amount of oxygen. The desired effect is also increased by the refreshing influence of cold, which must here be taken into consideration. I may here refer to the eagerness with which the asthmatic sufferer rushes during an attack to the cold night air, while he does not experience the same relief from compressed air of the same density, and possessing therefore in the same volume the same amount of oxygen, as he does from inhaling the greatly cooled atmospheric air. There is frequent opportunity of making the same observation with regard to other sufferers from apnœa, such as tuberculous patients, those afflicted with stenosis of the air passages, with cardiac affections, &c.

The effect of inhalation of cold air by means of the respirator can of course be only palliative in certain cases, as it cannot exercise any curative influence upon chronic difficulty of breathing, emphysema, nervous asthma, pulmonary tuberculosis, croupous or septic affection of the larynx, trachea, or bronchi. Whether the action of cold on an emphysematous lung may for the moment rouse the elasticity of the pulmonary tissue, and so, by lessening the expiratory insufficiency, cause the removal of a part of the residual air, highly charged with carbonic acid, from the dilated pulmonary vesicles, while it conveys at the same time a relatively larger amount of oxygen to the lungs, and thus considerably promotes the exchange of gases, this theoretically may certainly be possible, but is not yet established by a sufficiently large series of reliable observations. This

hypothesis, however, seems to me highly probable from the immediate effect which inhalations of cold air produce during an asthmatic attack, and which cannot be explained solely by the mere increase of the oxygen contained in the inspired air. We should not be justified, however, in at once inferring from these phenomena that in inhalations of cold air we probably possess a means of restoring emphysematous pulmonary tissue to its normal condition. We must for the moment be content if in the future we succeed in procuring in an asthmatic attack or any other form of apnœa the relief which for the present is afforded only rarely and temporarily.

In croup and diphtheria of the deeper air passages the chief value of inhalation is to preserve the life of the patient till suppuration is set up, leading to the detachment and expectoration of the membranes, or, if this does not take place, the liquefying them first of all in some other way (v. infra, Diphtheria, &c.) We must above all things beware of waiting too long in such cases, and so losing the most suitable time for tracheotomy, which is frequently inevitable, and thus be obliged to perform this operation under less favourable conditions.

6. Finally, as regards the styptic effect of the inhalation of cold air, it will be limited, as we have already said, to capillary hæmorrhages of the upper part of the respiratory tract, which may be arrested, however, more rapidly and effectually by other means. It is quite useless in hæmorrhages from the deeper bronchi and from the lungs, as has been proved by practical experience. On the other hand it may be useful in the after treatment of persistent hyperæmia, taking care to avoid too high a negative pressure in the thorax, and its employment seems to be specially indicated in cases of frequently recurring capillary hæmorrhages.

#### *b. Cold Water.*

Water, especially ice water, has also been used for the application of cold to the respiratory organs, as this, reduced into the finest spray, can be inhaled deeply into the bronchi.

But in this case, far more than inhalations of strongly refrigerated air, secondary warming interferes with the effect, as the aqueous particles, as we have already shown, even in passing

from the apparatus to the mouth of the patient, alter in temperature and absorb heat or become resolved into vapour. This phenomenon will naturally obtain still more the further the particles penetrate into the respiratory organs, so that when they reach the lower part of the air passages they are scarcely at all cold, and the effect of the inhalations is little other than that of water.

It is obvious that for the pulverisation of cold water we must use only such apparatus as are independent of heat (steam) as a motor power; we must therefore especially select those constructed upon Matthieu and Bergson's principle, the spray from which also penetrates more rapidly into the oral cavity and is less heated by the warmth of the room than is the case with apparatus founded upon Sales-Girons' principle.

*Mode of Action and Indications.*—In order to form an accurate estimate of these physical processes, before pronouncing judgment upon the application and effect of pulverised cold water we must first consider in what cases it can be used.

1. In the upper part of the respiratory organs, in the mouth and pharynx, cold water, like cold air, has a refreshing and moistening effect, and to some extent also lessens hyperæmia, so that its application is indicated in cases in which these mucous membranes are erythematous, dry, and hyperæmic, as in catarrhal and phlegmonous inflammations, either idiopathic or appearing as sequelæ of other affections, e.g. the general infectious diseases, typhus, the acute exanthemata, &c.

So also in chronic catarrhs attended with heat and dryness, in so-called *pharyngitis sicca*, cold water is quite invaluable, and many invalids cannot do without it. Seitz has used the spray of ice-cold water with advantage in *angina tonsillar*is.

In cases where ropy secretion, difficult of expectoration, adheres to the mucous membranes, especially to the posterior pharyngeal wall, as in many forms of pharyngeal catarrh, a partial liquefaction of such masses may be at once effected by these inhalations, and their expectoration facilitated. When, however, the secretions form tough and firm crusts, upon which simple water will not exert a sufficiently solvent action, recourse must be had to remedies which have a decidedly solvent influence.

Cold water administered in the form of spray will produce similar results also on the mucous membranes of the larynx and to some extent of the trachea too, and will exercise a cooling, refreshing, and moistening influence in the case of singers, public speakers, teachers, officers, &c., after violent exertion of their vocal organ. So also after violent exertion and overheating of the vocal organ, producing considerable evaporation of water from the surface of the mucous membrane, it will act as a solvent and liquefy the scanty, viscid mucus which under such circumstances is secreted. Masses of secretion even more tenacious and richer in cellular elements may be partially liquefied and made easy of expectoration by the cold-water spray. We may therefore use these inhalations with advantage in chronic catarrhs of the larynx and of the trachea, whether simple or secondary.

2. The deeper the aqueous particles penetrate into the trachea and bronchi, the fewer they become, and the more rapidly will they become warmed by the surrounding air and in part resolved into aqueous vapour, so that in such cases we must no longer expect them to exert any refrigerating influence. On the other hand, as their temperature is still lower than that of the pulmonary air and the respiratory mucous membrane, they will in some measure produce a refreshing effect, and in some degree moisten the mucous surface.

It is only when the inhalations are continued for a sufficiently long time, longer than is customary, from thirty to sixty minutes, that they exert a liquefying influence upon the secretions contained in the bronchi, for the amount of spray which penetrates into the bronchial tubes is generally much too small to be capable of giving off water enough to liquefy sufficiently the tenacious, adhesive, firm secretions in the larger and smaller bronchi. We must never forget in this case, as also in the case of the medicated inhalations to be subsequently enumerated, that the quantity of fluid becomes less and less as it penetrates deeper and deeper into the air passages, and that the surface over which they spread, if they have really penetrated, becomes more and more extensive.

In these regions of the respiratory organs, then, the action of cold-water spray entirely coincides with that which we obtain



by the inhalation of emollient, solvent fluids and warm vapours. We may therefore refer to the latter for further details.

3. In cases of dyspnœa, especially in advanced tuberculosis, it has been observed that patients breathe water spray better than ordinary air, and even in asthmatic dyspnœa inhalations of cold water afforded unmistakable relief. We are therefore fully justified in attempting to give relief in such cases by the application of the spray of cold water, especially when the ordinary remedies have failed us.

Inhalations of cold spray have also been much recommended in croup and in laryngeal and tracheal diphtheria, but in these cases warm spray and emollient aqueous vapours are more in repute. After the operation of tracheotomy the inhalation of pulverised water may also be adopted, but, according to our present experience, it is better to choose, instead of pure water, medicated solutions, especially disinfectants and solvents, which respond more to the indications than ordinary water spray (v. infra, Diphtheria).

4. Lastly, cold-water spray, pulverised ice water, has been used to arrest hæmorrhage. Fieber was the first to recommend its use in pulmonary hæmorrhages.

Lewin also expressed the opinion that cold-water spray, even if only slightly cooler than the air of the room, would, in accordance with physical laws, exert an astringent influence upon the mucous membrane and the vessels of the bronchi.

There is no doubt, however, that this influence will always be a very insignificant one, and will gradually diminish the farther the spray penetrates into the very regions which are the chief seat of the hæmorrhages, where it absorbs heat, so that eventually it will exercise no cold effect whatever. Even in hæmorrhages from the mucous membrane of the trachea, the larynx, and the pharynx we should not waste time in trying experiments with inhalations of cold-water spray, but proceed at once to more energetic and effectual measures.

## 2. EMOLLIENT REMEDIES.

*Mode of Action.*—These substances, when applied in a suitable form to the mucous membrane, alleviate the irritation produced by acute, subacute, or chronic inflammatory processes,

without themselves entering into chemical combination with the albuminates of the tissue. They act locally partly by their contact and their diffusion over the surface of the mucous membrane, and partly by penetration into the more superficial epithelial strata and layers of the pathologically altered mucous membrane.

The remedies belonging to this class contain in the water which is their chief constituent, and which itself relieves irritation, simply either a small amount of some readily volatilisable aromatic substance, usually not more precisely specified, or some of the constituent parts of seeds which, when triturated and mixed with water, form real or semi-emulsions, or they contain bland, unirritating fatty oils, which when used are usually triturated with some emollient body, or with gum or mucilage; lastly glycerine, either simply dissolved in water or in combination with some other remedy, is used for the same purpose.

When these substances are brought into contact by inhalation with the diseased mucous membrane, they will, wherever from inflammation and swelling it has become hot, dry, and tense, produce a cooling, moistening, and relaxing effect; they will loosen hard, inspissated, or ropy secretions, liquefy them, and facilitate their expulsion. In parts where the mucous membrane has been deprived of its epithelium, or which have become the seat of superficial or even deeper excoriations, these substances may form a protecting covering under which the injured mucous membrane and the more or less exposed nerve terminations are protected from irritation, especially from the irritation of the atmospheric air, as well as of the secretions and also of many ingesta.

The effect of the increased temperature at which these inhalations are used is to produce, in cases which admit of healing, energetic cell-proliferation in the mucous membrane, over which a layer of pus corpuscle and young formative cells collects, while the serous infiltration is reduced by a more rapid current of lymph through the lymphatics, whereby the tissue is relieved from the accumulation of blood and plasma. Where the epithelium is lost and superficial catarrhal and even deeper ulcerations have been formed, a healthy suppuration and cell-formation will take place, by which the injuries to the tissue

will be replaced, while the retrogression of the pathological changes accompanying these injuries will be accelerated. By means, then, of emollient, protective, and relaxing applications—

1. The irritation of the inflamed tissue will be reduced in a degree noticeable by the patient himself, and

2. The healing process will proceed more rapidly in cases where this is possible.

*Indications.*—In all inflammatory processes of the mucous membrane of the respiratory tract, attended with increased irritation of the parts affected, we may employ emollient remedies simply for their topical action with the twofold object—

1. Of improving the subjective condition of the patient by diminishing the painful sensations which are produced by constantly recurring irritations which reach the affected mucous membrane from without ;

2. By keeping off these injurious sources of irritation and presenting at the same time more favourable conditions, it may be possible for the pathological process to run its course in a shorter time than would otherwise be the case.

The diseases which require the employment of protective, emollient, and relaxing applications are—

1. *Catarrhal Inflammations*, whether acute or subacute, in which the mucous membrane of the air passages becomes hot, dry, tense, stiff, and swollen, denuded of epithelium or covered with deep erosions. When this is the case the oxygen of the atmospheric air acts as a violent irritant on the mucosa and produces a sense of burning and soreness in the affected part. If the larynx, the trachea, or the bronchi are especially attacked, each inspiration may be constantly attended with tickling and a desire to cough, while, if the mouth and pharynx are affected, the contact of the ingesta at the posterior part of the epiglottis and of the larynx is followed by burning and smarting, difficulty of swallowing, and an irritative cough.

2. *Parenchymatous and Phlegmonous Inflammations.*—In these cases emollient applications will be especially indicated, where cold is either no longer suitable or has not been well borne, or when from any reason it does not act favourably. Inflammations of the mouth and pharynx as well as of the larynx may lead to suppuration or ulceration. The irritation

of the dark red, hot, dry, tense mucous membrane, projected by the generally diffused infiltration of the sub-mucous tissue far into the cavities of the organs affected, will be greatly lessened by emollient remedies, which moisten the surface and cover it with a protective layer of emulsified oil, gum, or vegetable mucus, while the subjective condition of the patient is greatly improved until the swelling disappears or the abscess discharges.

3. *Pseudomembranous Inflammations*.—I wish to group under this head specially those diseases which are characterised by the formation of a coagulated fibrinous exudation on the surface of the mucous membrane, such as diphtheria and croup, as well as those maladies in which the mucosa of the respiratory organs participates in the general disturbance, such as scarlet fever, measles, scurvy, syphilis, and in diseases of the sub-maxillary bones, &c. In these diseases oily, mucilaginous remedies are less effectual than emollient vapours in combination with solvent or antiseptic substances, which promote the loosening and detachment of the adherent membranes. The pain also attending the secondary swelling of the adjacent parts will be relieved by the action of hot vapours and by irrigation with the spray of some vegetable infusion, &c. For the disinfecting and antiseptic treatment of these processes see farther on.

4. *Ulcerative Processes*, especially those of an inflammatory or erethic character, in which the ulcers are in a state of hyper-irritation. These ulcers, according to their situation, may be either more or less protected from mechanical irritation, or they may be constantly exposed to it, and the pain thus produced may become unendurable and lead to functional disturbances. This will be especially the case with ulcers of the pharynx or at the margins and apex of the epiglottis, on the posterior external surface of the larynx, &c., so that deglutition often becomes impossible, and the patient from inanition is still further reduced. It is rarer for ulcers of the vocal cords, of the processus vocales, or of the posterior laryngeal wall, by their painfulness to give occasion to such disturbances. These ulcers may (*a*) be of a *favourable* character, in which by the inhalation of medicated fluids injuries have been warded off,

and where this has been followed by rapid repair of the loss of substance by abundant cellular proliferation and young connective tissue with or without any considerable cicatricial formation, or in which in the first instance a favourable reaction has been established by caustic and alterative remedies, a process which may subsequently be further advanced by the application of emollients and so ultimately end in recovery; or (b) there are others in which, in consequence of the *incurability* of the *fundamental lesion*, as phthisis and carcinomatous degeneration, recovery is almost or altogether impossible, and which therefore demand above all things a thorough palliative treatment. It is only by the persevering use of protective measures that we can procure for many of these patients even a tolerable state of existence. If phthisical patients suffer very great pain from ulcers occurring on the epiglottis, or on the posterior covering of the arytenoid and cricoid cartilages, and if it is impracticable to apply strong solutions of nitrate of silver in order, by the formation of a superficial albuminous combination, to provide a protective covering to the ulcerated surface, if only for a short time, or any other continuous operative treatment, then a combination of emollients with narcotic substances, if the former alone are insufficient, is generally effectual in reducing the excessive sensitiveness of the affected tissue.

5. Finally, in all cases of injury caused by *burns*, *scalds*, *corrosions*, from the swallowing or penetration in any other way of boiling or corrosive fluids, alkalies or mineral acids, into the alimentary or respiratory canal, when antiphlogistic treatment is no longer applicable, the use of emollients is indicated. In the same cases also when the irritable injured parts suffer mechanical irritation in speaking or swallowing, and are exposed to the contact of substances not altogether inoffensive, their irritability may be reduced to an appreciably less degree by protective measures. In advancing suppuration purifying, antiseptic remedies, aromatic infusions or narcotic combinations may be applied in conjunction with the emollient solutions.

These remedies are counterindicated in the cases cited only when, from excessive suppuration and mucous secretion, the surface of the mucous membrane is charged with those

exudations, expectoration is checked, and the lumen of the air passages is contracted under the simultaneous swelling of the mucosa itself, and thus dyspnoea, more or less severe, has been set up. In such cases the first thing is to attempt to remove these obstructions by solvent and expectorant remedies, and not till then shall we succeed by means of protecting and emollient applications in combating successfully the accompanying erethic conditions and the ulcerations of certain parts of the mucous membrane.

#### MEDICINAL SUBSTANCES.

##### 1. *Moist Heat, Aqueous Vapour, Aqueous Mist, Hot Water.*

The simplest form of emollient remedy is moist heat in the form of hot aqueous vapour or the spray of some indifferent fluid. The first of these was employed in ancient times by Hippocrates, Celsus, and Galen, and was again introduced into therapeutics in the seventeenth century by Bennet and later by Willis; but it was not universally adopted till the close of the last century. The latter was made possible by the invention of the inhalatory apparatus and has only recently come into use.

The simplest emollient remedy is pure unmixed aqueous vapour, the mist of water, as it is given off from a vessel containing boiling water, and which may be inhaled through a funnel or some other contrivance. Special apparatus for the purpose have been devised by John Mudge, Mandl, Jenner, and others. Instead of water milk has been used for evaporation (Hippocrates, Skoda), in which together with the aqueous vapour traces of an aromatic substance are volatilised, the action of which is not yet chemically ascertained, which gives milk its peculiar smell; for this reason the vapour of milk is preferred by many patients to simple aqueous vapour. The same may be said of the vapours of special emollient herbs, such as the radix althææ, from the decoction of which also aqueous vapour, together with an aromatic substance, is obtained, while their actual mucilaginous constituents remain behind in solution.

In the second form we must first take into consideration the heated water, which, resolved into spray by a pulverising apparatus, acts admirably as a medium for alleviating irritation.

The most suitable water for the purpose is distilled water or rain water, or boiled spring or river water tolerably free from solid ingredients. Water is eminently serviceable for dissolving the mucilaginous ingredients in the form of infusions and decoctions of the various emollient herbs—*radix althææ*, *radix glycyrrhizæ*, *flores verbasci*, *flor. malvæ*, *herba pulmonariæ*, in the proportion of 1 to 4 per cent. infusion or decoction. They are applied by placing their decoctions as fresh as possible in the receiver of a steam spray-producer, where they are pulverised in the usual manner. With infusions and decoctions are associated solutions of

### 2. *Gum Arabic.*

in water, which may be applied in 2 to 4 per cent. solutions, and perhaps even somewhat more concentrated. It is difficult to pulverise stronger solutions by means either of air or steam.

### 3. *Glycerine*

may also be used for inhalation diluted with water, under the same indications as the preceding remedies. In this case also the remedy must be diluted with twice or more its volume of water, to make it pulverisable. Finally, with these are also associated

### 4. *Oily Emulsions*

prepared from *ol. olivarum* or *ol. amygdalarum dulc.*, or from *ol. papaveris*. We generally mix 1 to 5 parts of oil with 1 to 2 parts of gum arabic and 100 parts of water. Stronger emulsions cannot be pulverised by the apparatus. Olive oil was recommended by Fr. Fieber as a protective and alleviating remedy in the dry cough of phthisis, and also in whooping cough by him and by Leiblinger; Lewin used oil of poppies and oil of sweet almonds with success for the relief of irritative cough.

## 3. NARCOTIC REMEDIES.

*Mode of Action.*—As narcotic remedies contain acrid as well as stupifying ingredients, they will act generally according to their chemical composition, and produce a stupifying, paraly-

ing effect in the most marked form of paralysing the sensorium, or they will at the same time act as irritants to the tissues and the different nerve elements, especially when the mucous membranes are deprived of their protective covering.

Some of these remedies are capable, if applied for a long time, of producing local anæsthesia. So also when narcotic substances are absorbed after inhalation, they will be attended by the same phenomena and

1. Produce a stupifying and paralysing effect upon the sensorium, ranging from a simple diminution of central excitability to complete unconsciousness ;

2. They also reduce existing irritable conditions in the several nerve tracts and the sensory and motor excitement consequent upon inflammatory and other processes, as well as paralyse that of the reflex centres.

Though in the case of one narcotic its effect may be so general that hardly any nerve region remains exempt from its influence, yet with another its influence is exerted by preference on quite distinct nerve tracts and over special physiological and pathological conditions and irritations, so that these remedies must be regarded as having specific actions. The organs which are accessible to the influence of the several narcotics when they are absorbed into the organism through the medium of inhalation, are in the first place the brain and the medulla oblongata, then the peripheral terminations of the sensory and motor nerves, the vagus and the sympathetic, and through these on the involuntary and voluntary muscular fibres and the vessels. Which of these organs suffer a diminution of their physiological excitability by narcotics, and which remain uninfluenced, or in which a stimulation and increase of excitability take place, is dependent on the peculiar physiological or rather pharmacological behaviour of the organs towards these several substances, and will be further considered in the description of the remedies in question. If these substances are conveyed into an organism in which, by special disturbances, abnormal conditions of excitement, of a pathological character, have been set up in the organs mentioned above, then they will produce changes in these conditions corresponding to their general influence on these organs. So that either the pathological state



itself is removed, or the organism is placed in such circumstances that it will be enabled to overcome the disturbances and their consequences more easily and completely.

If we now give therapeutic expression to the different action of these agents, we shall group them with reference to their absorption through the lungs in the following manner. These substances act—

1. By lowering the peripheral excitability of sensory fibres, calming, quieting pain, and in increased quantity inducing sleep, and are designated by the different authors as sedatives and hypnotics ;

2. By reducing the increased excitability of the motor nerves, and so quieting convulsive movements—antispasmodics ;

3. By lowering the excitability of the reflex centres after irritation of sensory fibres, e.g. alleviating cough ;

4. By benumbing and producing a depression of the sensorium amounting to unconsciousness and insensibility—anæsthetics.

*Indications.*—According to their pharmacological action narcotics are closely allied to emollients, with which they may also be combined, when the latter are insufficient of themselves to quiet the painful irritation proceeding from the pathologically altered mucous membrane. The effect which is obtained by this combination is simply to strengthen the special action of the emollients, which narcotic preparations on the whole do not alter. When they are applied to the affected mucous membrane, like topical remedies in general, they cannot act directly upon it, but, in proportion to their absorption, develop their peculiar property of quieting and soothing irritation, and thus increase the number of conditions upon which the rapid and favourable termination of the process depends.

Narcotics will then—

- (a) Be used with advantage in all cases in which emollients are indicated, but in which the violent peripheral excitement of the sensory nerves requires a more energetic reduction than can be obtained by their means. The fear has been expressed in various quarters that by using narcotics in large doses, especially in ulcerative processes, a too rapid and too copious absorption from the injured mucous membrane may occur, and severe

symptoms of intoxication may thus at once be induced. But I have never observed such symptoms developed, and I also believe that we have certainly not more to fear from this method than from all the various endermic methods hitherto practised.

(b) On the other hand, narcotics are sometimes combined with medicines whose action does not coincide with their own, but is to some extent opposed to it. Some medicines, when they are brought into contact with the mucous membrane, exercise a strong stimulating effect upon it and excite sensory as well as motor reflex action, pain, cough, and spasm, and it may be necessary to combine narcotics with them, in order that their therapeutic effect may not be counteracted by the irritation they tend to produce upon the surface of the mucous membrane, upon the denuded mucosa, and the exposed vascular lumina. In the first place it is especially the styptics, then the astringents, and in a certain sense also the solvents which make such a combination necessary. It is not necessary in such cases that every part upon which the medicines are to act should be readily susceptible of such irritation, but even outside this circle, either in the higher or lower parts of the respiratory tract with which the inhaled medicines come into contact, excitement may be produced leading to the manifestation of undesirable reflex movements.

(c) While the action of narcotics in these cases is to be regarded on both sides as only accidental and supplementary, and the main benefit to be due to other remedies, still in a series of diseases of the respiratory organs the disturbances are of such a character that the desired therapeutic effect can only be obtained by the influence of the narcotic media themselves. This applies to all those diseases in which an abnormal excitement of sensory and motor nerves either lies at the foundation of the whole network of symptoms or takes a very prominent part in their production, and is at the same time combined with an increased reflex excitability of the nerve centres. In this case the inflammatory and other changes of tissue, if they are present, are of somewhat subordinate import, and their restoration to the normal state after the removal of these irritating conditions will either follow of itself or with the partial aid of

suitable topical remedies. Lastly, where there are extensive changes of tissue beyond the hope of remedy, conditions may arise in which these nervous irritations and heightened reflex movements acquire such strength that they must be regarded as substantive diseases and combated as such. In such cases the paroxysmal attack may be momentarily subdued by whatever depresses these excited conditions, but the pathological changes of the organ remain behind, and may on the next provocation cause a renewal of the attack in all its violence; or in certain chronic changes in the air passages and lungs a paroxysmal excitement recurring from time to time (excitement of the branches of the vagus) is the disturbance which persists the longest; when it has disappeared the patient's condition will be easier.

Thus we have the following *indications* for the use of narcotics:—

1. In *irritative cough* or *nervous cough* as a simple neurosis, or with simultaneous inflammatory disease of the mucous membrane of the air passages accompanied with slight catarrhal changes.

2. In *cough* with a predominance of *spasmodic* symptoms, as in *whooping cough*, where the therapeutic problem is, in the absence of a specific remedy or of a method of combating the disease itself with success, to endeavour to alleviate and diminish the paroxysms.

3. In *inflammations of the lungs* and *pleura*, generally on the fifth or sixth day, when the greater part of the lung is hepatised, and another part is found in a state of collateral fluxion, and, owing to the sharp pains attending inspirations, they are superficial and insufficient. We may then by a strong narcotic influence (chloroform), almost amounting to benumbing the sensorium, enable the patient to take deep, full inspirations and prolong life till the crisis sets in, the fever and the pains abate, and a rapid solution of the inflammatory exudation takes place.

4. In *asthma*, not only catarrhal but more especially that nervous type in which the obstruction is chiefly attributable to spasmodic excitement of the involuntary muscular fibres of the bronchi, whereas in the former the accompanying catarrh is itself the immediate cause of the asthma and demands direct

treatment, while we at the same time endeavour to alleviate or remove the paroxysm.

5. In affections of the air passages and lungs attendant upon *pulmonary phthisis*, when during its chronic course irritative conditions are developed, such as tickling cough, nervous cough, oppression, difficulty of breathing, and asthmatic troubles dependent on painful, spasmodic, and reflex irritations. To reduce these irritative conditions, and so get rid of the results which they involve, is an imperative indication, considering the character of fundamental disease.

(*d*) Lastly, a number of the narcotic agents which are given in the form of inhalations for their therapeutic effect are not intended to act on the respiratory organs themselves, but are intended to be absorbed through the lungs into the circulation and there exercise rather a general than a local influence. The extraordinary volatility of various medicinal agents which come under this category, and the consequent rapidity with which they are absorbed, enables them to be introduced into the organism by inhalations and to be conveyed into the blood more rapidly and completely than by any other method, without a partial decomposition by the way.

According to their specific action upon the several nerve tracts or upon the sensorium generally, these remedies will be applicable—

1. In morbid processes in parts that lie outside the respiratory tract, to relieve distinct pathological symptoms (amyl nitrate in tinnitus aurium);

2. With the view of arresting the irritation and the reflex movement due to pain by inducing a rapid benumbing of the sensorium even to complete unconsciousness, whether these pains are caused by the disease itself or dependent on operative measures (ether, chloroform, nitrous oxide).

#### MEDICINAL AGENTS.

According to their chemical constitution and their behaviour when exposed to high degrees of temperature, narcotic remedies may be employed either in the form of fumigations or in the form of vapour, or in pulverised solutions.

It is only quite recently that narcotic fumigations have been re-introduced into the practice of medicine, although they were employed in antiquity for religious purposes, and in the treatment of certain nervous diseases which were ascribed to the influence of evil demons. This was especially practised by the so-called Magi, or miracle-working physicians.

Hufeland collected many observations out of the domain of what is called *medicina fumigatoria*, and published a series of cases which were partially cured or relieved by narcotic vapour-baths (herba hyoscyami and belladonna).

Opium, stramonium, nicotiana tabacum, belladonna, hyoscyamus, and the leaves of cannabis indica have been used as fumigations in which the fumes, or rather the products of dry distillation, developed by burning, when once inhaled, at once produce strong narcotic effects, while conium maculatum, nicotiana tabacum, atropa belladonna, datura stramonium, and hyoscyamus have been employed for infusions in which the narcotic substance was contained in aqueous vapour. At present we can use either the alkaloids of these narcotic plants dissolved in water or their infusions, or more rarely decoctions of their leaves, stalks, &c., for inhalations, by means of pulverising apparatus, and thus their uses and doses can be estimated with much greater precision than was possible by the former methods; nevertheless their application in the form of fumigations may still be useful in cases of marked individual idiosyncrasies and under certain special circumstances.

### 1. *Opium and its Preparations.*

It was in India and China that opium was first used for inhalation, where the custom of smoking narcotic substances—chiefly opium—had existed for centuries, the inhalation of which into the lungs exerts a calming and narcotising influence and induces a pleasant, agreeable sleep.

In Germany the fumes of opium were first applied to medicinal purposes by Ettmüller. He used to burn 0·6 to 0·2 gramme of opium on a hot iron close to the patient's bed, and make him inspire the smoke it gave off. He observed good results from it in hysteria, melancholia, and in cases of violent convulsions. 'The sleep was not in the least stertorous, the

blood was not driven to the head, and beyond an unusual feeling of comfort the patient remarked no enraptured ecstasy.'

The narcotic substances which are given off in the burning of opium are not yet accurately known, and it is not yet chemically ascertained whether one of the constituent parts of opium sublimes without being decomposed or whether new products of decomposition form which give rise to the intense narcotic effect observed.

At present opium, but especially the morphine contained in it, is used more in the form of pulverised solutions. The *tinctura opii spl.* and the *extr. opii aquos.* are inhaled either alone or in combination with aqueous solution of gum arabic, or some other mucilaginous body, especially for pain and irritation of the laryngeal and bronchial mucous membrane, for acute and chronic catarrh, and also for tuberculous and syphilitic ulceration, combined in the last case with mercury or preparations of iodine. The effect, as in the case of opium, varies with the individual, and Lewin advises us to begin with small doses and to increase them gradually. With the *tinctura opii spl.* a solution containing 0·2 to 2·0 per cent. is a suitable strength, while the watery extract has been used with advantage by Seitz and Schöller in 0·2 to 0·4 per cent. solutions for irritative cough, whooping cough, and in the first stage of pulmonary tuberculosis.

Like opium, morphia has also been used in acute laryngitis with violent irritative cough, in laryngeal phthisis, in chronic bronchitis with severe cough, as well as in the distressing cough of phthisical patients. Only the dose must, of course, be proportionately lower, and the solutions intended for inhalations should not contain more than 0·02 to 0·1 per cent. of morphia.

## 2. *Extractum Hyoscyami.*

For this preparation the same indications apply on the whole as for opium, only it has been thought that those cases are specially adapted for this remedy in which spasmodic symptoms prevail, as is the case in *tussis convulsiva* and other diseases (v. infra, Whooping Cough). Fieber has used the extract reduced to a 0·05 per cent. solution in a thin olea-

ginous mixture, and according to his experience this remedy does not shorten the duration of whooping cough, but distinctly diminishes the violence of the paroxysms. The employment of the extract of hyoscyamus in intense bronchitis has proved equally advantageous. Leiblinger also ordered it in inhalations to relieve pain in tuberculosis. Lewin begins with 0·1 per cent. and increases the dose gradually.

### 3. *Extractum Conii Maculati.*

This has been recommended by Nega in hyperæsthesia of the fifth and tenth pair of nerves, and Lewin uses it in cases of hyperæsthesia of the laryngeal mucous membrane in which there is a feeling of irritation without any apparent objective cause, or where it is out of proportion to the intensity of the exciting cause.

The dose, according to Lewin, should be 0·25 to 0·5 per cent. of the extract in solution in spirits of wine, if this is not counter-indicated, with the addition of 1 per cent. of bicarbonate of soda. According to Lewin its use is sometimes attended with brilliant success. I have myself used this preparation in a few cases of hyperæsthesia of the laryngeal and tracheal mucous membrane, with perfectly satisfactory results. Waldenburg uses the tinctura conii maculati in about 0·15 to 0·8 per cent. solution.

### 4. *Stramonium.*

The use of stramonium in diseases of the respiratory organs, especially in asthma, also originated in the East, where, as in the case of opium, the active ingredients are inhaled by smoking. At Madras stramonium-smoking is regarded as a specific against asthma. For this purpose the roots and the lower part of the stalk of the purple thorn-apple (*Datura feroæ*), freshly cut, are dried in the shade and then pounded till they look like coarse-grained hemp. The preparation is smoked during a paroxysm like tobacco, either alone or mixed with the latter, according as the patient is accustomed to tobacco or not. In this process the smoke must be inspired deeply into the lungs, as in the Turkish manner of smoking, and the saliva secreted during the smoking must be swallowed. In India men accustomed to tobacco-smoking are desired to begin by

smoking two clay pipes full daily, and women three pipes half full, to be interrupted whenever giddiness, nausea, and vertigo are set up. After a few days, when these secondary effects disappear, the patient increases gradually to four to five pipes daily, till the asthmatic attacks cease; then the remedy is discontinued till perhaps mild relapses, which seldom fail to occur, compel its resumption for a short time (Waldenburg).

In Europe the use of stramonium in this form has rapidly become popular in consequence of numerous successful results, and testimony of its specific action has been advanced by Miquel, Mühry, Trousseau, Salter, Thiéry, Merkel, and others, so that stramonium has taken a permanent place in the therapeutics of asthma, and especially in popular medicine.

Miquel recommended his patients who were almost cured by the use of stramonium to afterwards steep the tobacco which they smoked for twenty-four hours in a concentrated decoction of stramonium, and then to dry it slowly. Tobacco thus treated was said by him to possess soothing, anti-asthmatic properties. Soon afterwards cigars containing stramonium leaves within them came into use, and were recommended by Broussais, Cruveilhier, and especially by Trousseau. The mixture which Trousseau used for his *Espic* cigarettes was the following:—

Folia belladonnæ . . . . .	0.300 grm.
.. hyoseyami . . . . .	0.150 „
.. stramonii . . . . .	0.150 „
Extr. opii gum. . . . .	0.013 „
Aq. laurocerasi . . . . .	9.500 „

The leaves are cut fine and saturated with the aqua laurocerasi in which the opium is dissolved; they are then dried and filled into paper tubes which have also been previously saturated with aqua laurocerasi and then dried. Trousseau advised the smoking of two of these cigars daily.

In order to dispel the heavy vapour which is developed in stramonium-smoking Danneccy recommends that the leaves shall be previously saturated with a solution of saltpetre, which at the same time promotes their complete combustion.

Besides this, blotting-paper or filtering-paper saturated with a solution of extract of stramonium and rolled into *tubes antasthmaticques* for smoking, or else inhalation of the fumes



evolved by their simple combustion, has been recommended. Nitre paper (v. infra) has also been steeped in extract of stramonium and used in the same way. Nowadays a whole series of such stramonium cigars, cigarettes, tubes, and stramonium nitre paper are sold by chemists.

The results which I have seen in asthma follow the use of these preparations, and which in many cases are quite startling, depended chiefly on the fact that the inspiration of the smoke either from the cigars or more effectually from the tubes was followed by a violent fit of coughing, which liberated great quantities of clear, watery mucus, so that in a short time half a litre and more was expectorated, by which temporary relief was obtained. It was therefore not actually the soothing properties of the stramonium and nitre which were operative here, but the energetic stimulation which the smoke exercised upon the bronchial mucous membrane, and which by violent fits of coughing expelled the sero-mucous transudation effused into the bronchi. In cases in which the relief was not followed by expectoration, the asthma was not dependent on acute catarrhal swelling, but rather on spasmodic contraction of the finer bronchi. This must be assumed as the cause of the dyspnoea; moreover I have observed no remarkable result arise from smoking these different preparations *during* the attack.<sup>1</sup>

##### 5. *Cannabis Indica*.

Indian hemp, the preparations of which have been used internally even as substitutes for opium, has been, according to Pollak, used in Persia to a considerable extent and for a very long time in the form of fumigations in pulmonary diseases.

For this purpose the leaves and the stalks of cannabis indica are carefully dried, cut fine, soaked in solution of nitre, dried again, and used in pipes or cigarettes. These cigars have also acquired a certain reputation in relieving asthma, and those especially of Grimaud in Paris have had a very large sale. Demartis recommended that hemp leaves should be smoked for the sake of their narcotic influence in pulmonary phthisis.

<sup>1</sup> Oertel's experience under this head is certainly at variance with that of many other observers.—TR.

Leiblinger and Da Costa also give the extract of *cannabis indica* to relieve the cough of tuberculous patients.

#### 6. *Tobacco (Nicotiana Tabacum).*

Tobacco has also been used with success in asthma, especially in the case of non-smokers, as I have often observed ; but even in the case of moderate tobacco-smokers I have not infrequently seen more or less relief produced by it, chiefly when smoked in the Turkish fashion.

According to Salter, tobacco has an analogous effect to ipecacuanha ; only the depression produced by tobacco is deeper than that which arises from the internal administration of ipecacuanha, and it may even amount to collapse. But the relief is also more rapid and complete. Soon after the usual results of tobacco-smoking with those who are not accustomed to it, the well-known collapse akin to sea-sickness, giddiness, powerlessness in the limbs, sensation of utter weakness, cold perspiration, incapability of speaking or thinking, nausea, vomiting, have set in ; after these symptoms, according to Salter's observations, the asthma yields suddenly, as if exorcised by magic.

Even in hay asthma Salter says that smoking tobacco until nausea is produced not only gives more relief than any other remedy, but that it acts as a preservative against it, and he mentions a case in which a patient had an attack of asthma every time he forgot to smoke a cigar before going to bed. A fully developed attack might also be more or less mitigated by tobacco-smoking, but then a larger quantity of tobacco would be required.

#### 7. *Hydrocyanic Acid.*

Hydrocyanic acid and its preparations, *aqua amygdalarum amararum* and *aqua laurocerasi*, which have also been employed for inhalations, must be included amongst narcotics.

Pure hydrocyanic acid was first used by Deport and by Maddock ; the latter claims to have frequently observed a rapid and considerable relief in whooping cough and nervous asthma from its use. Latterly Lewin was the first to advise the administration of hydrocyanic acid in small doses, and Fieber

recommends 1 to 2 drops of acid. hydrocyanic. to 240 to 360 grammes of water. As he holds that absorption takes place more rapidly from the bronchial mucous membrane than from the stomach and intestine, especially when ulceration is present, he considers that these small doses are desirable as a precaution against symptoms of poisoning.

Lewin and Siegle recommend aqua amygdalarum amararum particularly for mitigating the irritating action of other medicines, as of astringents, especially ferric chloride, or in combination with emollients. Lewin administered it in inhalations of the strength of 0·5 to 3·0 per cent., whereas Siegle advised about 4 per cent. added to the solution of some other remedy.

The vapour of aqua laurocerasi was first ordered to be inhaled by Kriemer and Meyer, and afterwards by Brofferio in whooping cough. The latter heated coarse sand in a flat iron vessel, poured a spoonful of aqua laurocerasi upon it, and caused the patient to inhale the vapour by holding his mouth over the vessel, his head as well as the vessel being covered with a cloth. This treatment was repeated six times a day. During the first two days the patient seemed rather worse than better, but on the third day all the symptoms disappeared, and by the eighth recovery was complete. He states that he has observed this result in many cases.

We now use aqua laurocerasi chiefly as a sedative in painful affections of the larynx and of the other air passages, as also in violent irritative cough (Siegle). The dose is calculated at 2·0 to 4·0 per cent.

#### 8. *Bromide of Potassium and Bromide of Ethyl.*

Bromide of potassium in 0·2 to 0·5, 1, or 2 per cent. solutions.

Attempts have been made to utilise this remedy, almost exclusively limited to internal use, for inhalations, and it was expected that its local application would produce the same effect as its internal administration. But it is only when administered in large doses (1·0 to 2·0 or 5·0 for a dose) some 3 to 4 times and more in the day that bromide of potassium acts upon the reflex excitability and sensitiveness of the mucous membrane of the base of the tongue, the velum palati, the pharynx and larynx, so that the quantity required would

amount to 10 to 15 or 20 grms. It has also been stated by various authors that painting the above regions with strong solutions (1 : 1) had the effect of reducing reflex irritability and diminishing the excessive provocation to vomiting which is produced by coughing in many phthisical patients.

I have repeatedly convinced myself, and Waldenburg has also maintained, that bromide of potassium exercises no anæsthetic influence over the pharyngeal and laryngeal mucous membrane, even in strong solutions. Waldenburg proposes it as a resolvent remedy for allaying irritation in catarrhs attended with smarting sensations, especially in the throat, in violent, irritative cough, and in convulsive cough, especially in hysterical subjects. Gerhardt and Helmke have also employed it with the same intention in whooping cough. It has also been used in various quarters, and bromine also, in the treatment of diphtheria and croup, but the indication was altogether erroneous, as it possesses no antiseptic or disinfecting properties whatever, and is incapable of detaching croupy membranes, as was wrongly supposed; this I have repeatedly ascertained by experiment.

Turnbull<sup>1</sup> and Tervillon<sup>2</sup> have tried bromide of ethyl, hydrobromic ether, as an anæsthetic, and state that it has two essential advantages—one, that it does not irritate the respiratory mucous membranes, nor does it excite fits of coughing or choking when it is first inhaled, and, unless large quantities are used, it does not affect the heart or the respiration; the second, that patients, instead of exhibiting the pallor and corpse-like appearance which generally attends chloroform inhalations, manifest a decided congestion of the face and neck, which justifies the assumption that in the application of this remedy there is no fear of the dangerous cerebral anæmia which attends the use of chloroform. It provokes vomiting also less frequently than ether or chloroform.

Four, six, or eight grammes of bromide of ethyl are sufficient to produce anæsthesia, without the aid of any special apparatus. A simple compress, such as is used with chloroform, is all that is needed.

<sup>1</sup> Turnbull (Philadelphia), 'Ethyl Bromide, a New Anæsthetic,' *Med. and Surg. Reporter*, March 1880; *London Med. Record*, No. 4, 1880.

<sup>2</sup> Tervillon, 'Ethyl Bromide, a New Anæsthetic,' *Gaz. hebdom.*, No. 24, 1880; *Med.-chir. Centralbl.*, No. 31, 1880.

According to the observations of Turnbull, Levis, Sims, Conner, and Tervillon, the narcosis produced by bromide of ethyl is deep enough and of sufficient duration to admit of the performance of the greatest operations; on the other hand, it must always be remembered that the narcosis produced by this agent is sometimes fugitive, and that in all cases awakening is almost instantaneous.

It is therefore advisable to operate quickly as soon as the narcosis commences, and not to interrupt the inhalations of the ether till the narcosis is complete. It also greatly promotes a favourable result to calm the patient beforehand, to protect his eyes from the influence of light, and not to speak to him when narcosis is coming on. Lastly, it should be remembered that with bromide of ethyl the anæsthesia is sometimes completed before relaxation of the muscles has fully set in. The occurrence of râles or stertor from relaxation of the muscles of the palate and cheeks must be taken as an indication that the narcosis has been pushed far enough, but it may be re-induced, if necessary, a little later on (Levis).

As an anæsthetic bromide of ethyl may occupy a place between chloroform and nitrous oxide, over which it has some considerable advantages.

### 9. *Ether and Chloroform.*

The low boiling-point of ether, 35° C., and of chloroform, 62° C., enables us to use them easily for inhalation even at the ordinary temperature.

Their anæsthetic action early suggested the idea of applying these remedies locally in the various diseases of the respiratory organs, attended or associated with increased irritability of the peripheral nerves, sensory and motor. But as the reduction and suppression of sensibility do not depend upon anæsthesia of the peripheral, but upon a temporary paralysis of the central apparatus, while the spinal reflex centre may remain still intact and the peripheral sensory nerves still remain irritable even under protracted chloroform intoxication, the results obtained by chloroform inhalations have therefore by no means answered to the expectations entertained in many quarters. It is only where the temporary removal of a peripheral irritable condition

can be brought about by a more or less complete benumbing of the nervous centre that distinct indications for the use of chloroform may be said to exist, and its inhalation, generally carried to the commencement of narcosis, be of any use.

In the last century it was tuberculous patients in particular that were experimented upon to a great extent with inhalations of ether, or ether in which some narcotic was dissolved, as *extr. cicutæ* (Pearson and Morton), *extr. belladonnæ* and *balsamus toltanus* (Maddock). Inhalations of ether were considered to be indicated chiefly in the dyspnoea and apnoea of the phthisical, especially when the oppression was very distressing, when they afforded the most complete relief (Clarke). Ether was also supposed to reduce the hectic fever, to relieve asthma, to promote expectoration and improve its character. Eberle also used the inhalation of ether with success in nervous asthma.

More recently chloroform has almost entirely supplanted ether even in inhalatory therapeutics, although indications for its use have not multiplied nor its application become more general. Chloroform inhalations have been used with advantage in many attacks of convulsive cough and whooping cough (Carrière, Churchill), especially with older children, as soon as the patient begins to feel the peculiar tickling in the chest which precedes the paroxysm; so also in spasmodic dyspnoea, which sometimes can be relieved by no other means, as in so-called spasmodic asthma; also in asthmatic attacks, such as occur in emphysematous patients and occasionally, though much more rarely, in the course of pulmonary phthisis (Spencer-Wells).

It may be indicated, in order to save life, in persistent, frequently recurring spasms of the glottis (Will), in chorea, when the muscular restlessness is continuous; in epilepsy, when the fits return incessantly, threatening pulmonary oedema; lastly, in very violent tetanus, when life is directly endangered by the spasm of the inspiratory muscles. About the end of the first half of this century chloroform inhalations were extensively employed in inflammation of the lungs in its different stages, and the results obtained by this new method were sufficiently marked to retain for chloroform down to the present time a distinct indication in the treatment of a disease the course

of which can be so little influenced by any system of treatment.

Baumgärtner was the first to experiment on a large scale with inhalations of ether and chloroform in pneumonia, and he found that in inflammations of the lungs, as well as other affections of the chest, these inhalations relieve the feeling of constriction, the stitch in the side, and diminish expectoration and sleeplessness; the cough, however, is sometimes aggravated in the early stage of ether inhalation, where there is a considerable accumulation of secretion, but in the course of time it also is relieved. Wucherer in the year 1848 published an original brochure on this subject, and Varrentrapp in the hospital of Frankfort-on-Maine, and Professor Theile at Berne, treated a great number of pneumonic patients with chloroform inhalations, in both instances with satisfactory results. Also V. Pfeuffer in his clinique at Munich, where I was clinical assistant during the years 1860-1863, administered chloroform inhalations to pneumonic patients, generally in the later stages of the inflammation, about the fifth or sixth day, where there was diffused hepatisation, accompanied with acute pleuritis, and when the breathing, in consequence of pains in the lung and pleura, became irregular, frequent, short, and superficial, and the expectoration was more or less suppressed, the bronchi were filled with viscid pneumonic secretion, widely diffused crepitant râles were heard, and often rapidly increasing cyanosis pointed to defective aëration in the lungs. The inhalations were administered frequently, 3 to 4 or 6 times a day, up to initial narcosis, and the result was entirely satisfactory in most of the cases which I observed. Generally, even before narcosis set in, the respirations became deeper, the pleuritic pains accompanying them less; the cough and the tendency to cough were diminished, and ceased altogether with the continuance of the anæsthetic treatment. Even afterwards the fits of coughing were less distressing and generally attended with more or less copious secretion from the bronchi, the irregularity and frequency of the respirations abated; even the first few inhalations relieved the oppression of the chest, which ceased for a longer or shorter time even after the narcosis had passed off; the râles diminished, there was a free exchange of gases in the lungs, and the

cyanosis decreased in a remarkable degree, and we generally succeeded in preserving the life of the patient till the critical day was over and resolution of the pneumonia set in. I have also frequently had occasion to observe the increased heat and sweating observed by Varrentrapp, Lorrain, and others. I consider inhalations of chloroform according to the preceding indications to be a valuable remedy in the treatment of pneumonia, and one not easily replaced.

The counter-indications for the inhalation of chloroform were stated by Baumgärtner to be tendency to headache, giddiness and rapid stupor, extensive engorgement of both lungs, and, lastly, general prostration.

If chloroform inhalations are to be administered with real benefit in inflammation of the lungs, the physician himself must conduct them, either by means of one of the chloroforming apparatus in common use or in the ordinary way, by dropping 10 to 12 drops of chloroform on a handkerchief and holding it before the mouth and nose of the patient in such a manner that a sufficient amount of atmospheric air may be inspired with the chloroform vapour. In other illnesses a similar quantity of chloroform may be poured into a wide-mouthed phial containing cotton wool or charpie, and the patient made to inhale it till he gets relief.<sup>1</sup>

The value of chloroform inhalations in surgery and obstetrics need not be considered here.

#### 10. *Nitrous Oxide.*

Pure nitrous oxide free from oxygen, when inhaled, produces, in human beings, symptoms resembling intoxication—buzzing and humming in the ears, indistinct vision, subjective sensation of heat, a feeling of extraordinary buoyancy and lightness in the limbs. Soon consciousness is completely lost, the respiration becomes dyspnoëic, and, when asphyxia is produced, the heart ceases to beat, the face becomes deadly pale, and the mucous membrane cyanotic. Removal of all feeling of pain

<sup>1</sup> Inhalations of chloroform afford great relief, and indeed form almost the only effectual treatment in those distressing cases of paroxysmal dyspnoea which occasionally occur in the later stages of some forms of chronic renal disease.—Tr.



usually coincides with the onset of cyanotic symptoms, so that the former may be concluded from the latter. If the narcosis is not pushed beyond this stage, an agreeable state of consciousness returns after 1 to 2 minutes. But if the breathing and the cardiac action stop, life may be restored by the speedy performance of artificial respiration (Hermann).

Nitrous oxide has for many years been extensively used as an anæsthetic, especially in dentists' practice, as the transient narcosis, lasting 1 to 2 minutes, which this gas produces is just sufficient for such operations, and the rapid loss of sensation and the pleasant feeling on recovering from it makes this species of narcotisation particularly agreeable.

Nitrous oxide has not so far been found applicable to the more important operations, because when complete unconsciousness is produced symptoms of asphyxia appear, arising from the total absence of air during the inhalations of the pure gas, and these necessitate the immediate suspension of the narcosis.

Paul Bert has tried to obviate this disadvantage attending narcosis from nitrous oxide, without impeding its anæsthetic influence, in the following manner. The fact that nitrous oxide must be pure in order to produce complete narcosis leads to the conclusion that the tension of this gas must be equal to one atmosphere, in order that a sufficient quantity of it may penetrate into the organism; under normal pressure, therefore, the gas must amount to 100 per cent. But if the patient is made to breathe in an apparatus in which the pressure is raised to two atmospheres, the necessary tension will be maintained with a mixture of 50 per cent. of nitrous oxide and 50 per cent. of air. It will thus be possible to procure anæsthesia, while at the same time the normal proportion of oxygen is maintained for aeration of the blood, and the normal conditions of respiration are preserved.

When Bert caused animals to inhale a mixture of atmospheric air and nitrous oxide, contained in a bag under a pressure of two atmospheres, he succeeded in keeping up a state of complete insensibility for an hour with normal respiration; and each time when the bag was removed, and the animal drew 2 to 3 inspirations in free air, he witnessed a complete return to the normal condition. During the influence of the nitrous oxide

the animal manifested no sign of feeling when denuded nerves were bruised or limbs amputated; only calm respiratory and cardiac movements showed that the animal still lived. No secondary effects of any sort have been observed.

From the results of his experiments on animals, P. Bert recommends surgeons to employ nitrous oxide in the manner suggested by him.<sup>1</sup>

Quite recently S. Klikowitsch<sup>2</sup> has used a mixture of nitrous oxide with oxygen for inhalation in the proportion of 4 : 1, and has observed in several cases of angina pectoris (insufficiency of the semilunar valves) after 5 to 10 inhalations the paroxysms considerably shortened and relieved. In bronchial asthma also inhalations of nitrous oxide reduced the frequency of respiration and increased the depth of inspirations. In a case of aortic aneurism with distressing paroxysms of coughing, which sometimes lasted uninterruptedly for an hour, the cough ceased during the inhalations, and only recurred very slightly in the course of the next five minutes, after their suspension. A mixture of one part of nitrous oxide with three parts of oxygen produced a favourable influence upon the regulation of the cardiac movement; the pulse went down in this case from 120 beats in the minute to 100, became fuller and stronger, and the urinary secretion increased at the same time. In two phthisical cases the inhalations composed one patient to sleep and diminished the cough in the other; in this case the influence lasted several hours. In many instances where oxygen inhalations as such had no alleviating effect or very little, inhalations of nitrous oxide acted more favourably, without producing a feeling of dryness in the throat. In no case did he observe any harm from its use. For the favourable influence of a mixture of nitrous oxide and oxygen as an anæsthetic in parturition, v. 'Arch. f. Gyn.' xviii. p. 81, 1881.

Lastly, the record of experiments lie before us which have been carried out with favourable results by Blake and Hamilton<sup>3</sup> with nitrous oxide in neurasthenia, headache, sleeplessness, so also in cases of spinal irritation, nervous exhaustion, hysteria

<sup>1</sup> *Allgem. med. Central-Zeit.*, p. 55, 1879, and *Apoth. Zeit.*, No. 1, 1879.

<sup>2</sup> *St. Petersburg Medical Weekly Record*, 1880, No. 15.

<sup>3</sup> Blake and Hamilton, 'Preliminary Communication upon the Use of Nitrous Oxide in Melancholia and Nervous Exhaustion,' *New York Med. Record*, No. 5, 1880.

without apparent uterine disorder, melancholia, and delirium tremens. The gas had here a similar effect to alcoholic stimulants without the subsequent depression. According to both authors the use of this gas is counterindicated in sthenic affections, but chiefly in conditions which are connected with cerebral congestions, among which the hyperæmiæ of the plethoric are to be reckoned.

The effect of nitrous oxide in such cases depends essentially upon the greater or less admixture of atmospheric air, which can be regulated by opening a valve in the vicinity of the inhalatory tube, through which the outer air can penetrate. At the same time other effects, such as anæsthesia, intoxication, unconsciousness, must be guarded against, and so soon as the fingers begin to become numb, or the look somewhat wandering, the inhalations must be suspended. According to Blake and Hamilton a certain quantity of the gas may be inhaled every day without detriment to the health, if only it be sufficiently diluted with atmospheric air.

#### 11. *Nitric Ether, Nitrite of Amyl (Amylenum Nitrosum).*

Nitrite of amyl, discovered by Balard in 1844, according to the investigations of Guthrie, Gamgee, Brunton, Wood, Eulenburg, Pik, Fihlene, and others, exercises an influence chiefly upon the vascular system and produces intoxication and insensibility.

So small a quantity as two to five drops, inhaled by a healthy individual, produces in half a minute an intense flushing of the cheeks, which also extends more or less over the whole upper part of the body, associated with a sensation of heat, an intoxicated feeling of weight or giddiness in the head, cardiac palpitation, pulsation of the carotids, dilatation of the cerebral vessels, and increased frequency of pulse. On the other hand the retinal and pulmonary vessels (Fihlene) take no part in the dilatation. With the increase of cardiac activity and frequency of pulse occurs a great lowering of the blood-pressure, increasing more and more the longer the nitrite of amyl is inhaled, reaching on an average about fifty millimetres of mercury. The tension in the arteries decreases, and the sphygmographic tracing shows the complete disappearance of

dicrotism on the descending side of the curve. Again, the temperature of the skin, especially of the face and of the upper half of the body, rises, while the temperature in the interior of the body is lowered.

With the suspension of the inhalations these phenomena subside rapidly; but after prolonged inhalations, or in the case of sensitive or anæmic persons, after the inhalation of one to two drops, complete unconsciousness, fainting, and shock-like collapse may occur. In other cases persistent dryness in the throat and irritative cough may be observed during and after inhalations of nitrite of amyl.

We do not yet possess a satisfactory theory of the action of these ethers, and the phenomena observed in human subjects were at first referred to the muscular coats of the blood-vessels and a paralysis of their (vasomotor) nerves caused by the inhalations, and supposed to proceed either from peripheral or central parts of the vascular nervous system.

This remedy was tried therapeutically in cases in which the symptoms were supposed to be caused by arterial spasm, excessive tension in the arteries in the region of the cerebral vessels, causing arterial anæmia of the brain and other parts of the nervous system, as of the spinal cord and of the nerves of special sense. Among these were to be classified those forms of migraine which were termed *hemierania sympathico-tonica* or *angiospastica*, answering to the forms of *angina pectoris*, while, according to other theories, convulsive neuroses, such as epileptic, eclamptic, tetanic, and hysteric attacks, were also favourably influenced by inhalation of nitrite of amyl. In lead colic which is attended with excessive arterial tension nitrite of amyl produces decrease of pressure and temporary cessation of the pains. It was also found to act as an analeptic in cases where the excitability of the respiratory centre had sunk below that of the vasomotor centre, as in Cheyne-Stokes's respiratory phenomenon (*Fihlene*). As to its efficacy in asthmatic cases, we are not in possession of sufficiently numerous observations. Biedert has administered nitrite of amyl in combination with compressed air in asthma with success.

In most of these conditions inhalation of nitrite of amyl should only be attempted when the patients turn pale at the

very outset of the attack, and where symptoms of spasm of the cerebral vessels are present; it should be avoided where the face becomes cyanotic from the first (Rossbach). It may also be employed in certain affections of the visual and auditory apparatus, attended with diminished local supply of blood from arterial anæmia or ischæmia, as in cases of amblyopia combined with pallor of the optic disc and of the retina, and in many cases of tinnitus aurium and otalgia.

The inhalations must be watched by the physician himself. Pour 1 to 5 drops of nitrite of amyl on a handkerchief or blotting-paper, and hold it in front of the nose of the patient, who should sit on a chair and make deep inspirations. If the patient should collapse, artificial respiration must be at once attempted, together with cold affusion and cutaneous irritation. It is best to begin the inhalation with the smallest possible doses, and where the remedy is tried for the first time the practitioner should begin with one drop, and increase very cautiously. In order that the dose may be exact, it is well to use drop glasses and lymph tubes, which are only capable of containing one to two or three drops.<sup>1</sup>

#### 4. ASTRINGENT, STYPTIC, AND CAUSTIC REMEDIES.

*Mode of Action.*—The remedies hitherto mentioned, when they come in contact with the mucous membrane, exert no direct action on the tissue itself. If the texture of the tissues had been altered by inflammatory or other pathological processes, these remedies were only useful in warding off certain external injuries or secondary conditions of irritation produced in a reflex manner, so that the pathological process going on in the mucous membrane might be influenced favourably in its action, and a more rapid development of the reactionary symptoms (suppuration and new cell-formation) be promoted. They exerted no influence upon the histological elements so as to directly combat the inflammation, nor was it desirable they should, since all such influence acting upon a highly irritated mucous membrane would have aggravated the inflammatory symptoms.

<sup>1</sup> Small capsules containing a definite dose are commonly used in this country.—Tr.

But we now come to the consideration of remedies in the treatment of diseases of the respiratory organs, which exert a direct influence upon the morbidly irritated tissues, and so on the development and the course of the disease itself.

Astringent, styptic, and caustic remedies act, according to their chemical constitution, directly—

1. Upon the epithelial and cellular structures on the surface of the mucous membrane; upon these especially, and also upon the mucosa and submucosa denuded of epithelium;

2. Upon the connective-tissue elements, elastic fibres, and involuntary muscular fibres;

3. Upon the capillaries and larger bloodvessels;

4. Upon the lymph channels, lymphatic vessels, and secretory organs;

5. Upon the sensory, motor, and nutritive nerves;

6. Upon the fluid of the tissues and on the blood;

7. Upon the albuminous bodies of the organised tissues generally.

These various actions upon the tissues in general are effected first by the absorbent and desiccative properties of some of these bodies, and also by their capability of forming insoluble combinations with albumen, precipitating albumen from its solutions, and forming a coagulum with the constituents of the blood.

The epithelial cells which have been loosened and swollen by inflammatory serous exudation as well as masses of young deciduous cells are destroyed by absorption of their water and by combination of these bodies with their albuminates, and thus an impulse is given to vigorous new cell-formation; while at the same time the salts and astringent substances, by absorbing water through the epithelial layer, from the connective tissue of the mucosa and submucosa, act as desiccants, and diminish the quantity of fluid which infiltrates these tissues.

They also, in virtue of these properties and of their stimulating influence, cause constriction of the contractile parts of the mucous membrane, which is attended by a diminution of secretion and transudation, while at the same time the emigration of the white blood-cells is prevented by contraction of the vascular walls. In this way not only is the fluid secreted on the surface of the mucous membrane reduced in quantity,

but the fluid infiltrating the tissues is also lessened and contraction of the mucosa and submucosa is induced. This effect will be further increased by the concurrent stimulation of the sensory, motor, and nutritive nerves, and these again exert a reflex influence on the contractile elements of the mucous membrane.

When these substances come into contact with the blood itself (as, for example, when it is diffused over the surface of a ruptured vessel), they at once precipitate its coagulable elements and produce thrombi which, extending into the vascular canal, close the opening. But as they at the same time come into direct contact with the ruptured and denuded vascular walls, they stimulate these to energetic contraction, and so cause complete closure of the rupture.

In a degree of concentration beyond that which can be employed for inhalation, a portion of the astringent combines directly with the tissue, and, destroying its anatomical structure and vital properties, forms an albuminate, which is detached from the subjacent parts over which it forms a more or less thick crust. The extent of tissue thus destroyed by dilute or concentrated solutions will depend on the density, resistance, and vital energy of the tissues on the one hand, and the caustic properties of the substance and its affinity for albumen on the other. A degree of concentration sufficient sometimes to destroy fungous excrescences will produce no corrosive influence upon the normal mucous membrane protected by its epithelium.

These substances, by means of this property of combining with albuminous bodies even in feebly saturated solutions, not only destroy the vital properties of the albuminous bodies with which they come into contact, but also the fermentative activity of those organised bodies which occasion decompositions of various kinds, and, by destroying their influence, act to some extent as disinfectants.

Lastly, when of a certain concentration, they will, by the irritation which they exert upon the tissues and the vasomotor nerves, create an inflammatory excitement which results in hyperæmia, increased transudation, and accelerated flow of fluid in the parts affected, and occasion, in processes running a chronic course, disturbance and absorption of old inflammatory deposits, and promote their dislodgement and removal

*Indications.*—The following are the cases which call for the use of astringent, styptic, and caustic remedies :—

I. *Subacute and chronic catarrhs* of the mucous membranes, attended with hyperæmia, increased transudation, swelling and softening, serous or cellular infiltration of the mucosa and submucosa.

The surface of the mucous membrane may be covered either with thin fluid, sero-mucous or muco-purulent secretion, or a viscid, scanty, inspissated secretion may adhere to it, which can only be detached with difficulty. The epithelium is swollen, softened by serous effusions or purulent infiltrations, and the surface covered with deciduous cells or pus corpuscles. The mucous glands, distended with secretion, either discharge it in great quantity on the surface or remain swollen by its accumulation, or occasionally distended into cysts by occlusion of their excretory ducts, or by compression or obstruction from inspissated secretions and exudation plugs.

The connective, the lymphatic, and the elastic tissues are also infiltrated with serous fluid or present generally an abnormal aggregation of cells in patches. The capillaries and veins are dilated and distended with blood corpuscles and present a condition of passive hyperæmic stasis. The lymph channels and lymphatic vessels are filled with plastic lymph, more or less laden in parts with white blood-cells; they are dilated, and present numerous flaky granular bodies, resulting from the breaking down of these cells. The lymph stream itself is retarded, tissue-change becomes sluggish, and the inflammatory exudations due to the original acute attack remain, undergoing very slow metamorphosis, only to a slight extent absorbed, and, instead of undergoing extensive fatty change, either those parts which have been absorbed are replaced by fresh inflammatory products or receive other additions, more or less abundant.

Again, the sensitiveness and painfulness of the affected parts is generally slight, and the sensory reflex actions which are liberated by them—spasmodic movements, coughing, choking, spasm of the glottis—do not form a prominent feature in most cases, and may be altogether absent; in a few isolated cases, however, they are more pronounced, while the other symptoms



of catarrh have also a subordinate importance. In these cases also the catarrh may be prominent or exclusively of a secondary nature, caused by mechanical injury due to the violent reflex movements, such as occur in various neuroses. Astringent remedies are then either powerless or tend only to aggravate the already over-excited nerves. It is only after the neurosis is relieved or has disappeared that they can promote a retrogression of the catarrhal changes. We may employ astringent remedies, then, in all cases in which the respiratory mucous membrane has become the seat of the pathological changes which we have described, and which form the anatomical basis of the clinical phenomena; they are as follows:—

1. *To the mucous membrane of the mouth and pharynx:* in simple subacute and chronic angina catarrhalis, tonsillitis, and pharyngitis;

2. *To the larynx:* in subacute and chronic laryngitis catarrhalis, especially when localised in the form of chronic catarrhal epiglottitis, arytænoiditis, mesoarytænoiditis, chondritis ventricularis and vocalis, &c.;

3. *To the trachea:* in subacute and chronic catarrh of the trachea, and

4. *To the bronchi:* in subacute and chronic bronchitis, in which the constitutional conditions are normal, or when they have already undergone some morbid change from anæmia and chlorosis, scrofula, chronic pneumonia, from previous syphilis, or in consequence of emaciating illnesses. In these latter instances the application of astringents will fulfil only one of the indications present, and the result will be influenced by the co-existent manifestations of the general disorder.

II. *Hæmorrhages.*—Owing to the property these substances possess of coagulating albuminous and fibrinous fluids, and of producing an astringent effect on the tissues and especially on their contractile elements, they are also valuable for arresting hæmorrhages, in cases where it would be impossible to apply ligatures and compresses or energetic refrigeration. The conditions under which they are available are that the hæmorrhage should be from the surface of the tissues, that the opening in the injured vessels should be free, and that the remedies themselves can be brought into continuous contact with them in the

necessary strength and quantity. The less these conditions obtain, the more uncertain will be the result of styptic inhalations.

III. *Neoplasms*.—There are two ways in which caustic fluids, when carried by the inspiratory current into the air passages and the lungs, may destroy any neoplasms that exist therein—1st, by breaking up the chemical constitution of the organised structures and combining partially or wholly with some of their constituent elements and forming albuminates, saponifications, &c.; 2nd, they may act in a simpler way, viz. by the absorption of water and the formation of coagula in their tissue, and so destroy their vitality and gradually set up a process of mortification.

But this can only take place when these fluids come into contact with the structures which they are to dissolve in sufficient quantity and concentration. Besides, their action must be limited to such parts as appear as foreign bodies in the organised structure of the mucous membrane, and whose removal without any injury to the adjacent parts is the object we have in view. We may here observe that in the inhalatory method of applying medicinal bodies they diminish in quantity the deeper they descend into the several parts of the respiratory passages, which are therefore proportionally exposed to their influence.

Therefore the attempt to remove certain structures by means of inhalation presupposes a considerable difference of vitality and resistance in the parts which come into contact with the substances inhaled, some having to bear this contact without suffering any damage, while others suffer mortification and gradually disappear. With these necessary presuppositions we shall find, however, that but few formations are so soft, vulnerable, and readily disintegrated that mortification is set up in them through irrigation with the inhaled substances, if the parts higher up, which are exposed to a stronger current, and the adjacent mucous membrane remain intact.

According to my experience hitherto of growths occurring in the larynx and in the trachea, there are scarcely any neoplasms which answer to these conditions. If, then, we hear in different quarters of the disappearance of papillomatous or other structures in consequence of the inhalation of astringents,

these growths must have been at most filamentous or fungous, ill nourished and imperfectly developed excrescences which often form on the margins of ulcers in laryngeal phthisis, but disperse of themselves in a few days or weeks, without the aid of any astringent or caustic agency. All other formations which occur in the larynx always possess vitality enough to resist strenuously all the influences that can be brought to bear upon them by means of inhalations. I have myself had repeated opportunity of witnessing in many patients during the most careful application of inhalations ordered by others the development of papillomata which were capable of offering considerable resistance even to the excising knife.

We are forced to conclude, then, that the inhalations of astringent or caustic media are valueless for the removal of neoplasms, and that these cases must in every instance be dealt with by some other mode of treatment. Such attempts are founded wholly on a misapprehension of the range open to this local treatment of the respiratory organs, as well as the means at its command and its attainable object, and they could be only possible in an age when it is thought justifiable to expect every imaginable curative result from a new method.

#### MEDICINAL BODIES.

As drugs of this class are not vapourisable, their topical application in aqueous solutions to the deeper-seated parts of the respiratory tract, the mucous membrane of the trachea, of the bronchi, and to the pulmonary surface itself, was first made possible by the invention of Sales-Girons' pulverising apparatus, although they had been frequently applied before in a pulverised form, by insufflation into the pharynx and larynx or by inhalation through the medium of Darwin's brush apparatus, or by the introduction of a solution by means of a syringe, brush, or sponge to the more accessible parts.

##### 1. *Tannic Acid (Acidum Tannicum).*

As astringent in 0·2 to 3·0 per cent. solution.

As styptic in 1·0 to 10·0 per cent. solution.

Tannic acid, or tannin, is used as an astringent and as a hæmostatic.

According to the observations hitherto made, tannin acts chiefly upon the surface of the mucous membrane, contracting it and diminishing its secretion; it also acts upon the free mucus which it coagulates, and upon the secretions generally, which it modifies.

These properties make it available in subacute and especially in chronic catarrhs of the respiratory mucous membrane with copious secretion, and that along its whole extent from the fauces down to the finer bronchi. In chronic catarrhs with very scanty secretion other remedies are more suitable.

Usually after a few applications the secretion is visibly diminished, expectoration is less frequent and less copious, somewhat more consistent however, but it is not on that account more difficult of expulsion.

But if it is used in too large a dose it may be followed by dryness and huskiness in the throat, a feeling of oppression on the chest, and difficulty of expectoration. This is all the more probable since by the direct application of astringents to the secretion a coagulation of the mucus occurs immediately; the mucus then remains hanging in flakes on the walls of the respiratory tract, and the smaller its quantity the more difficult it is for the patient to expectorate it.

In order somewhat to lessen this secondary effect, when such patients inhale tannic acid, I have always added common salt to it, and have observed that it has the effect of greatly diminishing the feeling of heat, dryness, and difficulty of expectoration.

In acute catarrhs tannic acid, as indeed all other astringents, must be avoided, as it only aggravates the existing irritation and sometimes produces rapid exacerbation of the subjective and objective symptoms; it never succeeds in arresting the acute inflammatory process, which is the object in view.

Tannic acid, in combination with carbolic acid, has also been used in simple catarrhal erosions; in chronic pulmonary phthisis, not only in the initial stage but also in the stage of softening of the caseous infiltrations and the formation of cavities; lastly, in bronchorrhœa and bronchiectasis, for the purpose of diminishing the secretion from the mucous membrane.

Tannic acid has also been recommended by Trousseau in

œdema glottidis and gangræna pulmonum, by Stephan in whooping cough, and by Barthez, Trousseau, Lewin, and Fieber in croup and diphtheria. With regard to the two last diseases I would only call to mind that diphtheritic and croupy membranes harden in tannic acid solution, so that their detachment and removal are impeded.

As a styptic tannic acid is useful chiefly in slight hæmorrhages from the air passages, and was recommended especially by Dr. Polansky, who treated a number of cases of hæmoptysis with it. Fieber has also used it with success in these cases, and Waldenburg called attention to the fact that tannic acid causes a rapid coagulation of the effused blood, and a very concentrated solution of it may be used, as it dissolves in water in the ratio of 1 : 3.

It should be remembered that solutions of tannic acid ought to be examined from time to time, and replaced when they have become opaque and flocculent, partly through the separation of gallic acid. A solution of tannic acid in glycerine and water, first used by Demarquay, keeps better; tannic acid glycerine, which he recommends in chronic pharyngitis, is a mixture of 1 part tannic acid, 50 parts glycerine, and 100 parts water.

An effect similar to that of tannic acid, but weaker, is produced by most preparations obtained from plants containing it; to these belong rhatany (Trousseau and Bataille), oak bark, infusions and extracts of which, or other preparations soluble in water, can be used for inhalations. They possess no kind of advantage over pure tannic acid.

## 2. Alum (*Alumen Depur.*)

As astringent in 0·2 to 2·0 per cent. solution.

As styptic in 1·0 to 5·0 per cent. solution.

The action of alum as an astringent and styptic is on the whole not essentially different from that of tannic acid, so that what has been said of the preceding preparation holds good generally of this, and it may sometimes be difficult to decide in practice which of the two remedies is to be preferred.

According to Waldenburg, who made most use of this remedy, alum has, like tannin, an astringent influence upon

the surface of the mucous membrane, and a modifying one upon the secretions, but less energetic. On the other hand, he says it is absorbed with extraordinary readiness by the mucous membrane, and is thus capable of acting energetically upon the deeper-lying parenchyma of the mucosa and of the tissue beneath it, as well as of promoting the contraction of the blood-vessels in the deeper layers. Thus Waldenburg was of opinion that tannin acted with more energy temporarily upon the surface of the mucous membrane, but that alum acted more lastingly and extended deeper. He therefore preferred alum whenever he had to deal with processes not purely catarrhal, but parenchymatous, consequently in those inflammations of the pharynx and larynx in which the whole tissue of the mucosa, or even of the submucosa, is swollen, and also in most cases of phthisis pulmonum.

He considered also that as a styptic it was valuable, since its action extends deeper and specially causes contraction of the bloodvessels, so that the result obtained was more permanent than with tannin. On the other hand, it is less soluble in water, only in the proportion of 1 : 18.

Lastly, in the practical estimation of these two remedies regard must be had to the peculiar taste of individuals, and to the very marked idiosyncrasy in some patients in favour of one preparation or the other, so that the question may be decided by the preference of the patient.

Fieber gives the preference to alum in inflammatory and irritable conditions. Its action seems to him then to be analogous to that of preparations of lead. Lewin used it in diphtheria. Its hæmostatic influence is said to be more permanent than that of ferric chloride, and Tobold in particular has collected numerous cases in which it has acted favourably. Dr. Polansky has also arrested pulmonary hæmorrhages with alum, so has Schlesinger in Berlin. When irritable conditions are present, it may be advisable to combine a narcotic, such as opium or its preparations, with alum, as also with tannic acid. Alum has also been employed with success in the form of inhalations as an antiseptic, either alone or combined with tar water in ozæna, bronchorrhœa, bronchiectasis, and in putrid bronchitis.

3. *Ferric Chloride (Ferrum Sesquichloratum)*,

(or, according to the ordinary liquid form, the liquor ferri sesquichlorati of the German pharmacopœia).

As astringent in 0·2 to 2·0 per cent. solution.

As styptic in 1·0 to 5·0 per cent. solution.

Ferric chloride is not much used as an astringent, on account of unpleasant secondary effects; and as the indications for its use coincide with those for alum and for tannic acid, these remedies are substituted for it in all ordinary cases.

In the first place, when liq. ferr. sesquichl. has been used for some time it injures the teeth. Then, owing to its powerful astringent action, it makes the mucous membrane of the tongue and of the mouth sore, and as it were corroded. It destroys the sense of taste for a long time after each inhalation, and the appetite of the patient is more or less impaired by the quantity of liquid swallowed. For these reasons only weak solutions of ferric chloride should be chosen in cases in which the remedy, for the sake of its astringent influence, is to be used for a long time, and in this way it may be used as a prophylactic after hæmoptysis, with the view of preventing an early return of the hæmorrhage by its prolonged action, and it is said that with this treatment an unusually rapid increase of strength is observed, probably due to absorption of the iron. So also it may be used in colliquative conditions of phthisis, in which the ferric chloride inhaled into the bronchi and lungs not only reduces the secretion, but also, owing to the amount involuntarily swallowed, tends to cure any diarrhœa which may possibly exist, as Gerhardt and Waldenburg found.

Ferric chloride is also valuable as an astringent in the chronic bronchitis and bronchiectasis of anæmic persons and as an antiputrescent, either alone or combined with tar water in copious, fœtid sputum from dilated bronchi or cavities, and in pulmonary gangrene. Lewin has also used it in chronic pharyngeal and laryngeal catarrh, in croup and diphtheria, and also in hysterical aphonia.

According to Lewin this remedy is counter-indicated in the delicate, excitable constitution of those pale phthisical women with excessively vulnerable mucous membrane, in whom it may

give occasion to hæmorrhage by the very effect of its astringent action.

As a styptic ferric chloride has the advantage over all other preparations; it is of all others the most rapid and certain. When a hæmorrhage has assumed serious dimensions and threatens immediate consequences, concentrated solutions should be applied at once. As ferric chloride forms an insoluble compound with the albumen of the blood, it gives rise to a kind of thrombus in the smaller ruptured vessels; or if a large quantity of blood is collected in a cavity, it coagulates it, and thus perhaps opposes a mechanical obstacle to further hæmorrhage. It is of vital importance in these cases not to waste time in the inhalations of very dilute solutions, which are too weak to exercise a hæmostatic influence, but only irritate considerably the mucous membrane, and, provoking more or less violent cough, may keep up and aggravate the hæmorrhage. I have observed a series of cases in which hæmorrhages of alarming dimensions have been arrested in a short time by inhalations of ferric chloride, which had resisted other remedies, such as injections of ergotine and of sclerotic acid.

On the other hand, we must not omit to observe that there are many cases in which inhalation can do nothing, since the conditions necessary for the closure of the bleeding vessels are absent (v. supra), and no inhalations whatever can be borne.

The disagreeable and irritating odour of chlorine, all the stronger in proportion to the concentration of the solution, and unpleasant even in dilute solutions, is best disguised by the addition of aqua amygd. amarar. concentr.

#### 4. *Argentio Nitrate (Nitrate of Silver).*

In 0.02 to 1.0 per cent. solutions.

The strength of the solution employed must depend on whether it is to be applied to the mucous membrane of the pharynx and larynx, or lower down, to that of the trachea and especially that of the bronchi, but the degree of concentration must always be such that it shall act as an astringent, and not as a caustic.

The application of nitrate of silver is attended with some drawbacks, as the salt is very easily decomposed, and when



brought into contact with the epidermis under the influence of light turns it grey. For this reason the solution must be kept as pure as possible, protected from the action of light, and pulverised by means of glass apparatus. The skin discoloration may be guarded against by a mask of linen or pasteboard, as Richter and Niemeyer recommended, or an ointment composed of any kind of fat mixed with common salt may be smeared over the face or round the vicinity of the mouth, previously to inhalation (Waldenburg). Siegle makes the patient inhale through a sort of pasteboard funnel, shaped like a trumpet, or like an inverted lamp-shade, and the mouth is adapted to the smaller aperture. For the removal of any chance stains a solution of potassium iodide is preferable to that of potassium cyanide, when there are any abrasions on the surface.

Nitrate of silver, when inhaled by means of the pulverising apparatus, undergoes partial decomposition into chloride of silver from the chloride of sodium contained in the saliva, and albuminate of silver by combining with its organic constituents. As the salt forms analogous combinations with the glandular secretions in the pharynx, Lewin attributes to it a cleansing effect on the pharyngeal mucous membranes, so mechanically favouring the function of its glands, which is frequently interfered with by obstruction of their narrow excretory ducts by viscid and tenacious mucus. The further influence of the undecomposed portion of the salt seems to be antiphlogistic, as it constricts the contractile muscular fibres of the tissues and the vessels, and thus prevents their softening and over-distension. In ulceration of the pharynx and larynx the application of lunar caustic at once forms a coagulum with the purulent exudation covering it, and this coagulum adheres to the ulcerated surface, and forms a thin incrustation over it, protecting it from the air and even from slight mechanical irritations; thus nitrate of silver, as I have proved in numerous instances, acts as an anodyne and facilitates the healing process, when this is possible.<sup>1</sup>

Lewin recommends nitrate of silver in pharyngitis (0·1 to 1·0 per cent.); when there are superficial ulcerations he uses a higher strength (0·5 to 1·5 per cent.), and in diphtheria 0·1 to 5·0 per cent. With regard to pharyngitis, he is supported by

<sup>1</sup> Compare Lewin and others, p. 368.

Wedemann, who in Gerhardt's clinic has observed brilliant results from the use of nitrate of silver (0·3 to 0·4 per cent.); he also speaks favourably of its action in pulmonary tuberculosis. Siegle recommends a solution of 0·2 to 2·0 per cent. in inflammatory and especially ulcerative processes in the pharynx and larynx, and Niemeyer administered inhalations of 0·2 to 0·8 per cent. solutions in chronic laryngeal and pharyngeal catarrhs. Waldenburg uses it in weaker solutions.

Lastly, we must not overlook the possibility in protracted treatment with concentrated solutions—since the amount of nitrate of silver absorbed by inhalation cannot be so accurately measured as when it is given by the stomach—of producing the characteristic discoloration of the skin of our patient (argyria), although no such case has hitherto been reported.

#### 5. *Neutral Acetate of Lead (Plumbum Aceticum).*

In 0·5 to 3·0 per cent. solutions.

Neutral acetate of lead, when inhaled, gives rise first to a sweetish, then a nauseous, bitter metallic taste on the tongue, and a feeling of constriction which extends to the deeper parts of the pharynx and larynx.

Even in medium dilutions it throws down upon the mucous membrane a precipitate of lead albuminates, arrests all the secretions, and coagulates the albuminous constituents of the adjacent cells, and causes them to contract. The superficial vessels of the mucous membrane are strongly constricted, and ulcers are covered with a protecting crust by the formation of lead albuminates, just the same as occurs by the combination of silver with albuminous substances after inhalation of *argentum nitricum*. If any considerable quantity of this substance is swallowed during the inhalations, it diminishes the secretion and lessens the peristaltic movements of the intestines, causing constipation. Lastly, neutral acetate of lead, by its tendency to combine with albuminous bodies, exerts a deodorising and disinfecting influence.

Inhalations of acetate of lead are indicated in all inflammatory affections of the respiratory mucous membranes, attended with increased secretion. Weak solutions might also be service-

able in more acute catarrhs of the larynx and the bronchi, as they are less irritating than other astringents, and relieve the heat and pain more effectually. Fieber has recommended lead preparations for this purpose. Again, by prolonged application of the acetate of lead, we frequently succeed in checking the profuse secretion in bronchorrhœa, the so-called catarrhus pituitosus, when it occurs with or without bronchiectasia, and to this class are to be referred no doubt the cases of phthisis cured by lead, the phthisis pituitosa of the older authors (Rossbach). Simultaneous tendency to hæmorrhages from the bronchial mucous membrane may afford a double indication for the use of lead, for, besides promoting coagulation and the formation of thrombi, it acts as a hæmostatic by constricting the vessels of the bronchial mucous membrane and especially their denuded lumina. Waldenburg has used it successfully in phthisis, chiefly in the stage of breaking-down of caseous deposits and where there existed a tendency to diarrhœa. It has also been recommended in pulmonary gangrene. Fieber has found this remedy less effectual in chronic catarrhs of the respiratory mucous membranes than the other astringents, and it is generally counter-indicated in the cases of persons whose nutrition has suffered, and where there are disturbances of the digestive organs and persistent constipation. A black deposit of sulphide of lead forms on the margins of the teeth if they are neglected.

The non-official preparation, plumbum nitricum and plumbum oxalicum, have an analogous action to that of the acetate, but their solutions are not so easily decomposed by the carbonic acid of the atmosphere with the formation of carbonate of lead.

#### 6. *Sulphate of Zinc, Zinc Vitriol (Zincum Sulfuricum).*

In 0·5 to 5·0 per cent. solutions.

Sulphate of zinc, on the one hand, by combining with the albuminates of the secretions and of tissues, acts as an astringent and desiccant; on the other hand, it acts directly on the vessels, constricting them, and so increases its own effect in diminishing secretion. Taken in larger quantities into the stomach, it excites vomiting.

Its application is therefore indicated in all affections of the

respiratory mucous membrane which are attended with increase of secretion, but it must not be employed during the existence of any violent, acute, inflammatory symptoms. Where irritative conditions are present it may be advantageously combined with *tinctura opii simplex* or *extractum opii aquosum*.

It may also be used as a styptic in slight lesions of the vessels and hæmorrhages, in the blood-tinged expectoration of the phthisical, in virtue of its above-mentioned influence on the vessels. Its disinfectant and antiseptic properties are too slight to warrant its use for these purposes.

Sulphate of zinc was recommended by Fieber, then by Lewin, Türk, and Siegle, for inhalations in catarrhs of the pharynx, larynx, trachea, and bronchi. In the bronchorrhœa of emphysematous patients Fieber administered a 0·5 per cent. solution with marked success. He also found it serviceable in reducing the expectoration of a tuberculous subject; in this case the zinc sulphate acted at the same time hæmostatically, so that the sputa under its influence lost the previous abundant admixture of blood. In combination with the *tinct. op. simpl. gtt. vi.* to a 1 per cent. solution, or thereabouts, he used it with advantage in catarrh of the larynx and the trachea, attended with aphonia. Leiblinger also treated bronchial catarrh successfully with a 0·2 per cent. solution.

#### 7. *Sulphate of Copper, Copper Vitriol (Cuprum Sulfuricum).*

In 0·2 to 1·0 per cent. solutions.

Cupric vitriol acts chiefly as an emetic. Its action upon the mucous membranes is identical with that of sulphate of zinc, by which it can therefore be replaced. The percentage solutions in this case should be set somewhat lower than with the above-mentioned salts.

Solutions of sulphate of copper were first employed by Vogler in phthisis and laryngitis, then Da Costa found them serviceable in ulcerative laryngitis, while Trousseau found inhalations of cupric vitriol effectual against pulmonary gangrene.

### 8. *Sulphate of Iron, Iron Vitriol (Ferrum Sulfuricum).*

The action and doses of sulphate of iron are identical with those of perchloride of iron as a styptic and astringent in anæmic subjects. On the whole it can be easily dispensed with.

### 9. *Tinctura Ferri Pomata (Tincture of the Malate of Iron).*

In 2 to 5 per cent. solutions.

Tincture of malate of iron was first employed in inhalations by Lewin, in order to keep up the action of preparations of iron on the highly vulnerable mucous membrane of anæmic persons. As it contains only about 0·7 per cent. of iron the dose is larger than that of the preceding preparations of iron.

## 5. SOLVENT SUBSTANCES.

*Mode of Action.*—The solution of the secretions which accumulate in the air passages may be effected in different ways, according to the chemical properties of the substances contained in the solutions inhaled.

1. By the simple thinning of the secretion which collects upon the mucous membranes in greater or less quantity, so that it may lose the viscid, glutinous quality which causes it to adhere often pretty firmly in compact masses to the walls, depressions, and projections of the air passages, offering impediments to the current of air in coughing and hawking; being rendered more fluid, it can be more readily detached and removed.

For this purpose water is the chief agent and the substances dissolved in it are of subordinate importance. In individual cases certain indications may exist which make weak solutions of certain substances preferable to pure water, as when there is irritability of the mucous membrane and offensive odour of the secretions, which require mucilaginous and disinfectant remedies, or the patient may prefer a weak infusion of aromatic herbs to the taste of pure water.

2. By stimulating the secretory activity of the mucous glands, and by a copious secretion of thin fluid to dilute and

detach the viscid, consistent masses from the surface of the mucous membrane. There is a series of salts which pre-eminently exercise this influence upon the mucous membranes, and thus stand in opposition to the substances of the preceding group. Saline solutions also increase the secretion of fluid by causing hyperæmia and by stimulating the secretory nerves of the mucous membrane, and this must be regarded as a stimulating effect. By virtue of their chemical composition, through the water and the alkali which they contain, these inhalations will also exert a solvent and diluent influence upon the constituents of the secretions, and thus in several ways promote their discharge from the air passages.

3. By the substances contained in the water either causing a complete chemical solution of the consistent or formed ingredients of the secretory products, or by transforming them into a thin, slimy, gelatinous mass, rendering them easy of expectoration.

(a) The mucin of the viscid, slimy secretions is easily dissolved by dilute alkaline fluids, and when it has been converted by the evaporation of water into glutinous and almost hard crusts, if long exposed to the influence of these fluids, it swells up again, assumes a more rounded form, and its outer layers are liquefied and dissolved. This is more rapidly effected when the mucous glands also, and more especially those covered by the viscid, glutinous mass, are stimulated to more active secretion, and so throw it off from the surface of the mucous membrane.

(b) The amorphous albumen and that of the elementary tissues becomes in like manner thinned and dissolved when it is exposed to the contact of a sufficient amount of fluid, and pus-corpuscles and young formative cells swell up and are destroyed through the agency of pure water. This process takes place even more rapidly when the fluid which is inhaled contains more alkali, in which the albumen of these for the most part deciduous cellular elements readily dissolves. When therefore, owing to suppurating processes in the air passages or in the lungs, a large quantity of pus-corpuscles are secreted and tenacious muco-purulent sputa are formed, copiously charged with these and with disintegrated elements, more or

less blocking up the air passages, inhalation of water may now bring about a thinning and partial solution of the compact masses, so that they can make their way out more rapidly, and the air passages be thus cleared.

(c) Fibrinous exudations. The viscid, elastic, whitish or yellowish white, usually tubular coagula, composed of a substance nearly allied to blood fibrin, which is secreted as a product of inflammation on the surface of the mucous membranes, especially that of the deeper parts of the respiratory tract, when exposed to the action of certain alkalies and some organic acids, either dissolves without much difficulty, or they swell up after a short time and are converted into a light, gelatinous, translucent mass. For this, however, it is absolutely necessary that the fibrinous membranes should be exposed to the contact of a sufficient amount of fluid, and for a long time, its chemical composition remaining unaltered; or if during this time the inhaled fluid forms new combinations which no longer possess this solvent property, a sufficient quantity of the original fluid must be always at hand.

When these masses are brought into contact with a sufficient quantity of the solvent fluid in a test tube, their solubility will appear far otherwise than it does when they still adhere to the mucous membrane and are only sprinkled by the inspired fluid, which, resolved into fine particles, comes in contact with the atmospheric air and may be thus altered. The circumstances, therefore, are widely different in the chemical and in the therapeutic experiment, and the results of the one afford no presumption as to what will be those of the other. The difficulty of bringing about the desired result so effectually as we might expect from the chemical properties of the inflammatory products becomes all the greater the more difficulty we find in bringing the necessary quantity of the unaltered solvent to bear for a sufficiently long time upon the fibrinous exudations.

Thus the result depends not only on the right handling of the apparatus and the selection of the chemical agents, but also on conditions which the state of the disease may more or less interfere with.

*Indications.*—1. In *dryness of the mucous membrane,*

especially of that of the upper part of the respiratory passage, the oral, pharyngeal, and laryngeal cavities, more rarely of the nasal and naso-pharyngeal cavity, in pharyngitis sicca, inhalations of water, or of weak solutions of common salt or of sal ammoniac, have a moistening, refreshing, and soothing effect upon the mucous surface, which may be as dry as if rubbed with a cloth or may be covered with viscid, glutinous incrustation. These remedies do not here act in a directly curative manner, but as palliatives serving to relieve for a time some of the distressing symptoms which make this disease so intolerable. They will therefore necessarily be largely used in the complaints of which we have spoken, even when more active treatment is at the same time adopted, such as paintings of the pharyngeal and laryngeal mucous membrane with solutions of nitrate of silver or preparations of iodine. The healing process advances far more rapidly; the secreting activity of the glands is more and more stimulated; the dried secretion choking up the glandular excretory ducts is dissolved and their orifices set free; at the same time the dull glazy, dry epithelium is moistened and infiltrated with fluid, and all this will be far more promoted by inhalations lasting from 15 to 20 minutes frequently repeated than by brief garglings with the same solutions. Indeed, some cases have been reported in which these diseases were completely cured by the use of such means alone.

2. In *subacute, chronic laryngotracheitis* or *bronchitis*, attended with dryness of the mucous membrane and irritative cough. Here the secretion is either lessened or the expectoration impeded by scanty, viscid masses of mucus. The constant coughing and hawking thus induced is to be regarded as a mechanical irritant which always excites the mucous membrane afresh and keeps up the disease. If these irritating conditions are alleviated or removed by the conveyance of hot steam to the mucous membrane in combination with the inhalations, the catarrh generally takes a rapid course, and recovery ensues in cases which would long have resisted any other mode of treatment.

Where we have to deal with hypersecretion of the mucous glands, without exactly amounting to blennorrhœa, it is possible that, as a result of the large accumulation of secretion, especially



as it is generally tenacious, rich in cells, and difficult of expectoration, repeated acts of coughing and hawking keep up a state of irritation which again exercises a retarding influence on the course of catarrhal affections, especially of the bronchi. In this case no benefit would follow the use of astringents; on the contrary, they would coagulate the secretions and make them firmer, tougher, and more difficult to remove, and only introduce a fresh element of mischief by aggravating the efforts at expectoration, coughing, and hawking, without leading to any material benefit from the astringent action on the mucous membrane, owing to the vast accumulation of secretion.

Again, when the affections of the mucous membrane are dependent on incurable diseases, such as chronic pneumonia, tuberculosis, long-existing emphysema, and cardiac affections, by the inhalations of solvents in the manner already described the existing irritation of the mucous membrane may be reduced, and an improvement of the condition, so far as possible, even if only temporary, may be attained.

These remedies also exert a favourable influence—

3. When *puriform masses* accumulate in the larynx and in the trachea, and especially in the bronchi, in connection with ulcerative and suppurative processes in phthisis laryngis, and ulcerations in the trachea and the bronchi, in bronchiectasia and in peribronchitis. Here the more rapid and easier removal of the puriform masses from the eroded tissue will prevent further irritation and avoid the formation of decomposing masses upon the rough surfaces and margins of the ulcers, jagged and torn from long contact with the products of suppuration and disintegration.

Where decompositions have already been set up either through the agency of organic ferments or by proliferation of bacteria in the older, long-retained masses, the solvents must be combined with actual antiseptic and antiputrid remedies, or the latter must altogether supersede them.

4. The *inspissated contents of cavities* resulting from the suppuration and disintegration of the pulmonary tissue can, by means of alkaline and saline solutions, be more or less liquefied, and so more easily discharged through the air passages. This is all the more important because the advanced degeneration of

the pulmonary tissue leaves but a slight volume of air at the command of the patient for purposes of expectoration. Besides, in such cases ulceration has already been set up in the trachea and especially in the larynx, principally upon the superficial layer of the posterior laryngeal wall, having jagged, callous margins projecting far into the lumen of the larynx, also perichondritis of the vocal ligaments and the arytenoid cartilage; and often, finally, stenosis of the glottis follows, so that the substances brought up from the deeper parts clings here with extraordinary tenacity and in course of time suffers further decompositions. By long-continued contact with these corrosive substances, as well as owing to the difficulty of getting rid of them by violent coughing and hawking, the processes developing in the larynx are again injuriously affected, and this is soon seen in an aggravation of the subjective troubles, increased pain in coughing, speaking, and swallowing, and rapid decay of the tissue by the formation of eroding ulcerations.

5. *For the solution of fibrinous exudations* in the larynx, the trachea, and the bronchi the application of these remedies is urgently indicated, owing to the danger to life from obstruction of the air passages which these coagula threaten.

The solution of the false membranes formed by different pathological processes is accomplished in one of two ways; either the superficial laminæ swell up more and more, become dissolved, and the liquefied mass is coughed up, or the solvent fluid penetrates between the false membrane and the mucous membrane, melts down most of the delicate fibrillar connection between them, and the exudation is generally expectorated by the patient in the form of tubular crusts in larger or smaller quantities, with violent coughing or sense of choking. Unfortunately it is only in the rarest cases that this result can be obtained, for through the respiratory insufficiency, which is already considerable, only a limited quantity of the medicine, quite inadequate to the solution of the false membranes, can be conveyed into the deeper air passages, so that in the most favourable case only the most superficial layers of the fibrinous laminæ are dissolved; or the process spreads to such a depth or advances so rapidly in all directions that even a very copious admission of fluid fails to prevent the occlusion of the air pas-

sages. Lastly, it is possible, as I myself have frequently seen, after completely successful solution of the false membranes, after the dissolved gelatinous, mucous masses and fibrinous shreds have been expectorated, and free respiration has been perfectly restored, in a short time, for a fresh, generally more abundant, fibrinous exudation to be thrown out over the whole of the previously affected air passages, when the exhausted patient is no longer able to carry on the necessary inhalations with the same energy.

It must be borne in mind that the inhalation of these solvents exercises no arresting or limiting influence over the inflammatory process itself, but merely dissolves the fibrinous coagulum which it has deposited; there is therefore nothing to prevent a second secretion of fibrin, unless the inflammation has also itself been arrested and a favourable suppurative action set up. As we might expect, mechanical detachment of the false membrane is generally followed by even a more rapid and energetic exudation, in consequence of the greater amount of mechanical violence inflicted on the mucous membrane. The marvellously favourable results that have been published may probably be accounted for by want of precision in diagnosis, and this remark applies also to the results of tracheotomy. Nevertheless, seeing how little reliance can be placed on other treatment, tracheotomy not excepted, it is advisable, immediately upon the first discovery of false membranes in the larynx and the adjacent parts by the laryngoscope, when their presence is unmistakably indicated by the symptoms, to apply inhalations of suitable fluid solvents and to continue them carefully and perseveringly at intervals of 10 to 15 or 30 minutes for a quarter of an hour at a time. If the cough loses its dry, hollow sound, if it becomes gradually looser and accompanied by râles, we may conclude that the inhaled fluid has produced a favourable effect, and if the expectoration, at first rare and scanty, becomes more copious, mucous, gelatinous, and purulent, we may banish the least doubt as to the more or less complete solution of the obstructing membrane.

## MEDICINAL SUBSTANCES.

If we extend the limits of the application of these remedies somewhat further, we may include the use of solvent inhalations among the oldest recorded methodical local treatment of diseases of the respiratory organs, although they were at first indicated on empirical rather than on scientific grounds.

The favourable influence of residence on the sea coast or of a long sea voyage upon pulmonary invalids, observed by the old Greek and Roman physicians, must be attributed in great part to the influence of the large uniform amount of watery vapour contained in the sea air, as well as to the chloride of sodium it contains, although the physicians of that period were far from thinking of this explanation. We can give but hypothetical answers even now to the question how far the greater amount of oxygen contained in the sea air, or its deficiency in carbonic acid, or presence of iodine or ozone, or the increased atmospheric pressure are influential, whereas the effect of dilute solutions of common salt and of air containing it is accessible to direct observation.

More recently observations have been made in the same sense upon the curative influence of air charged with saline particles in chronic catarrhs and pulmonary affections, and the value of its inhalation has been ascribed directly to the common salt contained in it. But the older physicians had yet another salt which they used for inhalations by means of such appliances as were at their command before technical skill had constructed the apparatus now at our disposal, namely, sal ammoniac, which sublimes with dry heat into white vapours, and is available in this form, but without the simultaneous action of water and aqueous vapours.

No direct use could be made of other salts which exercise an equal and even a stronger influence upon the secretions and inflammatory products accumulated in the respiratory tract, because of the impossibility, at that time, of reducing them to a respirable form.

By means of the pulverising apparatus these salts can now be used in aqueous solutions, so that not only the salt but the

water which serves as an excipient for it is absorbed, and the influence of the latter is indispensable in the treatment of those very affections for which these salts are indicated.

### 1. *Common Salt (Natrium Chloratum).*

In 0·2 to 5·0 per cent. solutions.

*Common salt, chloride of sodium,* will exercise a different influence upon the mucous membrane of the respiratory organs and the lung, according to the different degrees of concentration in which it comes into contact with them.

If concentrated solutions of the salt are inhaled, they will absorb water from the surface of the mucous membrane of the respiratory tract and the lung, and induce a considerable hyperæmic fluxion. On the other hand, if we use highly dilute solutions a very considerable supply of water will be conveyed to these parts, producing a liquefaction of the viscid, glutinous mucus adhering to the walls of the trachea and the bronchi, which can thus be more easily detached from the mucous membrane and expectorated. Whereas concentrated solutions create hyperæmia, very dilute solutions seem in catarrhs of the respiratory organs to reduce the hyperæmic fluxion and at the same time to stimulate ciliary motion (Lewin). The neutral action of solutions of common salt is of importance in cleansing granulating ulcerated surfaces, whose young cells are destroyed by irrigation with pure water. It is difficult to decide to what extent the common salt that is absorbed from the respiratory mucous membrane during the inhalations, as well as that which is simultaneously swallowed and absorbed by the stomach and intestine, may contribute to the therapeutic effect, as it is believed to do by some.

Inhalations of solutions of common salt are useful chiefly in chronic catarrhs of the pharynx, larynx, trachea, and bronchi. They are most efficient of all remedies in dry catarrhs (pharyngitis sicca), in which the sparing or deficient secretion is gently stimulated by the salt, while the swelling of the inflamed mucous membrane is at the same time diminished. They are not applicable, any more than are astringents, in acute catarrhs, or in acute exacerbations of chronic catarrh, as in these cases they,

like the astringents, have an irritating influence on the inflamed mucous membrane. Waldenburg found chloride of sodium to be a valuable remedy in certain torpid forms of pulmonary phthisis, in which the disease follows a chronic course, but is attended with but little secretion, and the caseous pneumonia shows no tendency to acute exacerbations. The dry, distressing cough is frequently relieved by the inhalations of chloride of sodium; the secretion is augmented and expectoration thus facilitated. Waldenburg also observed an increase of appetite under the influence of inhalations of common salt, probably from the fluid swallowed, or possibly from the absorbed sodium chloride. This frequently became voracious immediately after the inhalations. This, together with the thirst excited by the salt, induced the patient to take much solid and fluid nourishment, which was also well assimilated. Thus the general nutrition and the strength of the patient improved.

As a general rule moderate degrees of concentration are used for inhalations; only in old catarrhs, in emphysema and asthma, stronger solutions, which then act as stimulants, may be called for.

## 2. *Sal Ammoniac* (*Ammonium Muraticum, Hydrochloratum*).

In 0.2 to 5.0 per cent. solutions.

Of all the alkaline salts *sal ammoniac* was the earliest to be widely employed as an internal local application in diseases of the mucous membranes of the respiratory organs.

Its property of subliming at a moderately high temperature led to its being used at an early period for inhalatory treatment, and as early as 1804 Fuchs recommended vapours of sal ammoniac, which he developed by means of a heated porcelain plate, in chronic catarrhs of the respiratory organs.

After Fuchs, Gieseler made use of inhalations of sal ammoniac, prepared by throwing 2 to 3 table-spoonfuls of sal ammoniac into a crucible and heating it over a spirit lamp. He thus cured in a few days chronic catarrhs which he had long been treating fruitlessly with other remedies, and even obtained marked improvement in a case of tuberculosis. The treatment

was renewed 2 to 3 times a day, and the patient not only inhaled the vapours directly, but also found himself for about 1 to 2 hours afterwards in an atmosphere saturated with sal ammoniac.

The chief drawback to this primitive mode of treatment is that the sublimed sal ammoniac can diffuse itself freely about the room and deposit itself on the walls and furniture and do them more or less injury. It is therefore preferable to sublime the sal ammoniac in a fumigating apparatus, or, as I have occasionally done, to place a large leaden funnel, or better one of earthenware or pasteboard, above a crucible in which sal ammoniac is being heated, and to conduct the vapours rising out of the tube into the mouth of the patient at a greater or less distance.

Again, there exist two methods of inhaling vapours of sal ammoniac in a nascent state, devised by Pusch and Lewin. The former recommends the following simple contrivance. He pours 5 to 6 grammes of liquor ammonii caustici into a coffee cup, and places in it a watch glass with 1 to 2 grammes of pure hydrochloric acid, so that the white vapours instantly formed may be at once inhaled by the patient.

Lewin has constructed for the same purpose a special apparatus which consists of three glass flasks, two of which communicate with the atmospheric air through glass tubes which reach down to the bottom of the flasks, and the third, with which the two others separately communicate, also by means of glass tubes, is brought into communication with the conduit pipe (fig. 16). Caustic ammonia is poured into one glass jar, pure hydrochloric acid into the second in proper proportions, while pure water strongly acidulated with hydrochloric acid is poured into the third, so that no excess of ammonia may pass into the jar which contains the vapours in a nascent state. If air is inspired through the apparatus by means of the conduit pipe, it passes through the first two jars and saturates itself with ammoniacal and hydrochloric vapours, which in their entrance into the third combine and form sal ammoniac, and can be inhaled by the patient. Moreover, a small quantity of either an oleo-balsamic mixture, or of oil of bitter almonds, or of creosote, may be poured into the third flask to strengthen

or modify the action of the sal ammoniac vapours, and may be inhaled together with them.

This apparatus was modified by Wintrich and others, so that instead of three flasks only two are used, one for the reception of a suitably diluted solution of ammonia, the other of a similar one of hydrochloric acid. The former flask communicates by means of its inflow tube with the outer air; the latter is brought into communication with the mouth of the patient by means of the conduit pipe. The vapours of sal ammoniac are here evolved directly above the solution of hydrochloric acid.

The inhalations with both apparatus are performed according to the Turkish manner of smoking, in which a deep inspiration is taken immediately after sucking at the tube. Lastly, we are

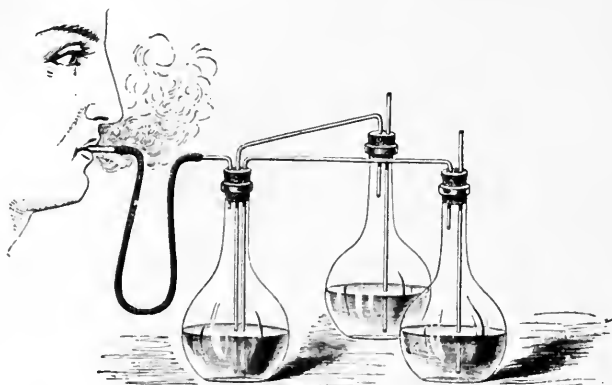

FIG. 16.

in possession of a third method of administering inhalations of solutions of sal ammoniac by means of the pulverising apparatus, and in this case the water in which the salt is dissolved is itself to be regarded as a remedy acting in the same way; and this mode of application ought nowadays in most cases to be preferred to the former methods.

The indications for inhalation of sal ammoniac concur pretty closely with those which have been established for the use of common salt in subacute and chronic catarrhs of the pharynx and larynx, of the trachea and bronchi. Lewin and Waldenburg also employed sal ammoniac in very dilute solutions in acute catarrhs of the air passages, and claim to have observed imme-



diate relief to the patient after these inhalations. The patient feels the annoying roughness in the throat and the bronchi rapidly disappear; the irritative cough is alleviated and the mucous secretion stimulated. In Prof. Gerhardt's clinic, who was then at Jena, sal ammoniac was used by Wedemann in emphysema and in simple bronchial catarrh with very satisfactory results, and Siegen mentions that inhalations of sal ammoniac produced a rapid improvement in a patient with catarrh of the smaller bronchi, who by a walk in cold damp air had suddenly brought on serious dyspnoea with a sense of suffocation. Waldenburg, on the other hand, uses sal ammoniac only occasionally in phthisis, and prefers other means for stimulating expectoration; and where there is fear of hæmoptysis he avoids sal ammoniac altogether.

As regards the dose, it is best in acute catarrhs to choose very feeble concentrations in the first instance; stronger doses of this remedy frequently irritate and do mischief where dilute solutions exercise a remarkably beneficial influence. Chronic catarrhs are capable of bearing stronger solutions; concentrated solutions may be employed in emphysema and asthma, where the object is to produce stronger stimulation and so promote expectoration. When sal ammoniac is employed in phthisis caution must be exercised as to the doses.

### 3. *Carbonate of Potash and Soda (Kali et Natrum Carbonicum Purum).*

In 0·2 to 2·0 per cent. solutions.

The combinations of mucin liquefy far more rapidly and completely in aqueous solutions of alkaline carbonates, potassium and sodium carbonates, than in the corresponding solutions of salt and sal ammoniac.

The viscid or glutinous secretions firmly adhering to the mucous membrane, and forming dried incrustations, at once dissolve under their influence or are loosened, swell up and partially liquefy, so that they may easily be detached from the mucous membrane and expectorated.

Sodium and potassium carbonates, therefore, are chiefly used in chronic pharyngitis, in pharyngitis sicca and granulosa, and

in other analogous affections of the mucous membranes of the larynx and the trachea in the course of which the same kind of secretions and incrustations are formed. The soda solution also exerts a stimulating influence upon the mucous membrane, already partially freed from the phlegm, and excites it to increased aqueous secretion.

Carbonate of soda has also been much used in acute catarrh and acute exacerbations of chronic catarrh; it has proved as effectual as sal ammoniac, especially in the initial stage of pharyngitis and laryngitis, and in acute angina tonsillar. Sometimes it is even more useful than sal ammoniac, in the milder character of its action and the speedier relief of the subjective difficulties of the patient. In croup and diphtheria also sodium carbonate has been tried as a solvent of fibrinous deposits; it stands, however, decidedly below other remedies in these affections. The salt has also been used in some forms of coryza and ozæna.

In general alkaline carbonates, if used at all in acute inflammatory processes, should be applied only in very dilute solutions, and the medium and stronger solutions should be employed only in chronic catarrhs having an obviously torpid character, and with scanty, viscid, glutinous secretion. In other affections other remedies and more energetic measures must be adopted to bring them to a successful issue.

#### 4. *Carbonate of Lithium (Lithium Carbonicum).*

In 0·2 to 2·0 per cent. solutions.

Förster was the first to prove that croupy membranes dissolve more or less in aqueous solutions of carbonate of lithium, and therefore he recommends this remedy for inhalation in croup and diphtheria.

I have frequently made use of it for this purpose; the inhalations were usually well borne, but I have hitherto obtained no better result with it than with the other solvent salts.

In dealing with fibrinous exudations we should begin at once with the strongest solutions, and, as the salt is readily soluble in water charged with carbonic acid, we should prepare a strong solution by means of carbonic acid water. Solutions of a lower percentage may be employed in catarrhal affections, just as carbonate of soda is.

5. *Chlorate of Potash.*

In 0·2 to 2·0 per cent. solutions.

The action of this salt is on the whole not very different from that of common salt.

At one time potassic chlorate had a reputation which is no longer justified in the treatment of aphthous affections of the oral cavity, stomatitis aphthosa, stomacace, as well as in aphthæ of the fauces, and was for a considerable time employed almost exclusively in their treatment, although a series of far more effectual remedies were available.<sup>1</sup> The remedy naturally acted only locally; no one in these days will believe in any local action through the medium of the stomach and intestine. Its disinfecting and antiparasitic influence, as I have shown elsewhere, is extremely slight.

Independently of these affections potassic chlorate was also preferentially employed in superficial ulcerations and erosions of the pharynx and larynx, especially those due to syphilis and mercury.

Lewin tried it in diphtheria, and I myself have often used it. But its action is not specific, and there is no reason for preferring it to common salt.

It cleanses the oral and pharyngeal cavity by continuous irrigation without injuriously exciting the inflamed parts, and in this way aids the action of hot vapours. The remedy may therefore answer to the indications in certain cases of diphtheria only.

6. *Nitrate of Potash and Soda. Nitre Fumigations.*

If we burn nitre with organic substances, as paper impregnated with it, it burns with little crackling detonations, and thick white vapours are evolved which, when inhaled in asthmatic attacks, exercise quite a specific influence.

The therapeutic employment of nitre fumigations for inhalation began in America, and Frivi adopted it for the first

<sup>1</sup> The author's slighting remarks as to the efficacy of this salt in various inflammatory conditions of the mucous membrane of the mouth, &c., will not be endorsed in this country.—TR.

time in Europe in the year 1843 with astonishing success in a case of asthma. Only a short time was needed to bring nitre fumigations into general favour both with physicians and patients as a palliative for asthma, and though, up to the present time, we do not possess a complete scientific explanation of its mode of action, this fact sufficiently establishes its beneficial effect.

According to Eulenburg's investigations the fumes which are evolved in the combustion of the nitre paper are composed chiefly of ammonia and carbonic acid, also, especially when the paper burns freely on a porcelain plate, cyanogen and potassium cyanide, lastly small quantities of carbonic oxide and free potassium. Opposed to this analysis is that of Smee, who obtained in 100 volumes of the gaseous compound 0.5 oxygen, 52.7 carbonic acid, 3.9 carbonic oxide gas, 1.2 hydrogen, and 41.1 nitrogen.

Judging by the mode of action of the fumes on the breathing and the results which follow, as I have constantly observed in a large series of inhalations, it is not so much their narcotic properties which act anæsthetically and anti-spasmodically on the bronchioles and lungs, but rather the stimulating effect of the ammoniacal vapours, which immediately upon their penetration into the deeper air passages give rise to violent coughing and copious expectoration of sero-mucous fluid. This coughing and the discharge of considerable quantities of mucus is generally followed by speedy relief of the paroxysm, and remission of the oppression and dyspnoea. It is the same effect as I have observed from the smoking of stramonium or hemp cigars and antiasthmatic cigarettes, in which also it seems to me to be less the narcotic than the stimulating action of the inhaled vapours and the expectoration thus excited which plays the leading part. How and in what way nitre fumigations act narcotically and purely antispasmodically has not yet been exactly ascertained.

For the preparation of nitre paper it is best to use moderately strong blotting-paper; Salter says it ought not to be too thin, because in that case it will not absorb sufficient nitre, nor too thick, because otherwise the fumes given off in its combustion would be too heavy. Red, moderately thick, blotting-paper

which contains no wool, or else ordinary white filtering-paper, is perfectly adapted for the purpose. The separate sheets of paper are placed in a saturated solution of nitre, and when they are thoroughly soaked they are dried in a suitable manner. This paper is cut into strips about 3 centimetres wide and 10 to 12 long, of which 1 to 2, or in some cases several, are necessary to produce the desired effect.

The burning of the paper itself is best managed on a porcelain plate; it is ignited at one end and is soon consumed, with the evolution of thick white fumes. The patient may either inhale these vapours directly by holding his mouth over them, or the paper may be burnt under a funnel, and the patient, taking the wide tube in his mouth, inhales the fumes mixed at the same time with atmospheric air. A small room, inhabited by the patient, can also be completely filled with these vapours. Nitre paper, smoked either as cigars or out of pipes, is only suitable when the patient is able not only to receive the fumes into the oral cavity, but also really to inspire them into the smaller bronchi in the Turkish manner.

Favrot has suggested that, instead of paper, German tinder (*Feuerschwamm*) should be saturated with solution of nitre, and the fumes given off in its combustion inhaled either out of a bottle provided with a doubly perforated cork or out of a pipe.

Salter also recommended that paper previously saturated with an infusion of stramonium should be impregnated with nitre, in order to combine the action of the stramonium vapours with those of the saltpetre in its combustion. Lastly, Guyot and Dennecy have recommended that instead of paper the fresh leaves of belladonna, nicotiana, digitalis, should be saturated with nitre, and the leaves then dried and smoked either in pipes or in cigars.

As a rule nitre fumigations, if they are begun early enough when an attack is impending, even before the actual outbreak or in its initial stage, produce most favourable results, and, at least according to my observations, exclusively in the manner described above. The attack may even be cut short, or at least made to assume a slighter form. At the climax of the attack the inhalation of vapours can only produce a transient effect, and nitre paper is a favourite palliative with sufferers from

asthma generally, so that they never like to be without some in the house. Waldenburg had a patient under treatment for years who burned nitre paper in his room every evening, and then, although not quite free from a sense of oppression and still with noisy respiration, slept through the night, but who, every time he omitted the fumigation before going to bed, was roused up in the night by an attack of asthma, which was only alleviated by careful fumigation.

The inhalation of nitre vapours is generally thought of special value as a palliative in asthma, but they are incapable of curing the disease or even of reducing the number of attacks. Waldenburg does not mention a case in which such an effect was produced by them; still they cannot well be dispensed with in the treatment of asthma.

### 7. *Sulphides of Sodium and Potassium.*

In 0.1 to 1.0 per cent. solutions.

Alkaline sulphides act as irritants when brought into contact with the mucous membrane, healthy or diseased, and in large quantities produce inflammation.

In combination with the secretions of the mucous membrane they experience, as in the stomach and intestinal canal various decompositions, and when sulphur is liberated, develop especially sulphuretted hydrogen, which soothes irritation and is a suitable remedy in catarrhs, in irritable conditions of the laryngeal and bronchial mucous membrane, also in spasmodic cough and difficult expectoration, like sulphur waters (*v. infra*). The influence of potassic or sodic salts upon the mucine also comes into play, dissolving it, and thus promoting expectoration.

Considering the free development of sulphuretted hydrogen even during the pulverisation, and the formation of sulphur compounds, especially metallic sulphides in the cavities in which the inhalations are employed, it will be well to avoid the use of these remedies as much as possible, especially as they can be replaced by others quite as efficient.

8. *Ammonia. Solution of Caustic Ammonia.*

Gaseous ammonia has only been sparingly used in diseases of the respiratory organs, although some experiments have been made with it, and to a certain extent with successful results.

Pure gaseous ammonia is an irrepressible gas. Smelling it in strong solutions creates a painful sensation in the nose, from affection of the nervus olfactorius, while irritation of the trigeminus produces tears and violent sneezing. If the concentrated gas is inhaled through the nose and mouth, violent coughing, spasm of the vocal cords, and choking are reflexly induced by strong irritation of the mucous membrane.

When brought into contact with the mucous membrane it produces, according to the quantity, more or less violent inflammatory symptoms, hyperæmia, profuse secretion, solution of the epithelium, fibrinous exudation, formation of actual croupous membranes, and extravasation into the tissue and on to its free surface.

Like all the alkalies, it promotes the solution of the mucine in mucus, thus liquefying it and, to a certain degree, facilitating expectoration.

In fumigations with hartshorn, which Galen mentions, carbonate of ammonia was evolved, and was used by the ancients as an excitant to stimulate the sense of smell and to promote respiratory movements. Ammoniacal gas in combination with camphor was employed by Harwood to relieve hoarseness and aphonia; the vapour from a mixture of sal ammoniac and carbonate of ammonia cured a case of aphonia of three months' standing, and Smee recommends inhalations of ammonia in a large series of ailments, chronic hoarseness, incipient angina tonsillaris, and asthma. He asserts that ammonia promotes expectoration by exercising a strong stimulating influence upon the respiratory mucous membrane, and evoking a copious secretion upon it, as it does on the conjunctiva of the eye and on the nasal mucous membrane; and Snow, who administered inhalations of ammonia through an apparatus with a mouthpiece, made the same observations.

According to these authors inhalations of ammonia were

more especially counterindicated in fever and acute inflammations.

In asthma Ducros and Rayer applied ammonia in the following manner. They dipped a brush made of charpie into a mixture of 4 parts of liquor ammonii caustici with one part of water, then squeezed it out and painted the soft palate with it. This application was immediately followed by violent coughing with expectoration of great masses of mucus and with speedy relief, while the attack either disappeared during the night or it assumed a milder character. In this procedure, however, care must be taken not to introduce the brush too far into the posterior part of the pharynx, or to keep it too long there; otherwise fits of coughing and violent spasms of the glottis are set up and a series of dangerous symptoms are superinduced.

Trousseau also recommends caution, and, to prevent such casualties, advises that the patient should first smell ammonia, that the solution for painting should not be too concentrated at first, and that the strength should be very gradually increased. Trousseau also had carbonate of ammonia placed near the bed of the asthmatic patient.

Ammonia in combination with carbolic acid and alcohol has recently been recommended by Hager and Brand for inhalations in acute nasal catarrh. The proportions of the mixture are 5 parts of pure carbolic acid, 5 of caustic ammonia, 15 of rectified alcohol, and 10 parts of water.

Waldenburg has also found this remedy efficacious in a few cases of catarrh. Unfortunately I have myself tried it in a great number of cases without obtaining any satisfactory result. Brand recommends the above mixture in other catarrhs of the respiratory mucous membranes; he pours a few drops on 3 or 4 folds of thick blotting-paper, places it in the hollow of the patient's hand, who, protecting his eyes, inhales deeply through the mouth and nose as long as ammoniacal and carbolic vapours are evolved. Waldenburg prefers to administer the inhalation in the simplest way, directly out of a glass jar containing the mixture or from a wide-necked phial.



9. *Lime Water (Aqua Calcis).*

Undiluted and 1·0 aq. calc. : 8·0 to 16·0 aq. dest.

Lime water is one of those chemical agents which, so far as they have been tested hitherto, possess most completely the capability of dissolving the fibrinous coagula which form on the mucous membranes in croup and diphtheria.

Küchenmeister was the first to ascertain by careful investigation this influence of lime water upon the croupous membrane, and after the publication of these facts Biermer made the first practical application of lime water in laryngeal and tracheal croup, and with successful results. A few weeks after Biermer I myself had the opportunity of making similar observations, and about that time I witnessed in a great number of croupous affections of the air passages a fairly good result from inhalations of lime water, as compared with other methods.

If small pieces of croupous membrane, either fresh or even after having been preserved in spirits of wine and previously well saturated with water, are placed in lime water, they dissolve pretty rapidly and generally completely in ten to fifteen minutes, leaving only a slight, flocculent sediment; the margins and the thinnest portions are first disintegrated, while the thicker parts become transparent. It is only the fibrinous coagula in the false membranes that the lime water dissolves; the more or less numerous cellular and nuclear elements, as well as the epithelial residue, are but little affected by it, and on chemical analysis remain as a sediment in the bottom of the test-glass.

Since in fibrinous exudation in the larynx, trachea, and bronchi the danger lies exclusively in stenosis of these canals and death supervenes from suffocation, the first indication, when this danger threatens, is the removal of the sources of obstruction either by mechanical or chemical means. If the croupous membrane in the air passages of the patient were acted upon by the inhaled lime water in the same way as they are in the test-glass, the treatment of the processes attended with fibrinous exudation would have been considerably facilitated by Küchenmeister's discovery. It would be an easy matter to

introduce enough pulverised lime water into the air passages by prolonged inhalation, that by continuous irrigation and washing of the membranes the same action and solution of the surface should take place as may be at once observed in simple chemical reaction on the extracted membranes. But this is not exactly the case. A large proportion of the calcium oxide in the solution is converted into insoluble inert carbonate of lime by the carbonic acid contained in the atmospheric air, the air in the sick room, and above all in the expired air. It is still possible, however, that, if the lime water is not too much diluted, a sufficient quantity may come into operation and under favourable conditions lead to solution and detachment of the fibrinous coagulum. It is therefore advisable to make use of the officinal lime water only, and that without any dilution, as it must never be lost sight of that the next expiratory current will throw down a part of the lime from the lime water which has happily penetrated into the deeper air passages. Küchenmeister has suggested the addition of a strong alkali, e.g. caustic soda, to the lime to combine with the carbonic acid; and as this, added to pure lime water, throws down a whitish precipitate, he diluted the lime water, and found as the most suitable proportion for inhalation 12·5 of lime water in combination with a 2·5 to 5·0 solution of caustic soda to 100 parts of distilled water. Biermer, on the other hand, considers this combination unnecessary, as, according to his observations, the lime in lime water does not pass completely and immediately into carbonate of lime, but enough of the unaltered lime water always remains present to exercise a solvent influence.

Lime water has been applied not only in diphtheria and in laryngeal croup, but also in croupous, subacute, or chronic bronchitis, and Biermer has employed it in bronchorrhœa. Waldenburg thinks it would be worth while to try it as a solvent and at the same time as a mild astringent in other chronic affections, as in many cases of pharyngitis, laryngitis, and bronchitis, and even in phthisis.

10. *Lactic Acid (Acidum Lacticum).*

In 4·0 to 10·0 per cent. solutions.

In connection with the alkalies some organic acids must be mentioned which are also more or less capable of dissolving croupous membranes. Amongst them must be placed, according to my investigations, acetic acid, formic acid, and lactic acid.

Of these solvents lactic acid has won and retained the highest reputation. It was first recommended by Bricheateau and then by A. Weber, of Darmstadt, in diphtheria and croup, and was afterwards very much used in these complaints. I have not myself formed so favourable an opinion of this remedy, and am more inclined to corroborate Küchenmeister's judgment.

Lactic acid by no means dissolves the croupous membranes completely, but under its influence the membrane becomes strongly bleached, swells up, and becomes lighter. It is not dissolved and disintegrated, as with lime water, and there remains a white, gelatinous, glutinous mass, which is by no means easy of expectoration. A great drawback to the use of the pulverised solution of lactic acid of the necessary strength is its action on the mucous membranes of the lips, mouth, and pharynx, where it sometimes produces a very painful erythematous inflammation.

Hitherto this solvent has been little used except in croup and diphtheria.

11. *Neurine, Trimethyl Ammonium Hydroxide,*

a highly volatile, strongly alkaline base, crystallising with difficulty, which extracts carbonic acid from the air and combines with acids and platinum chloride and forms crystallisable salts; it is obtained from the decomposition of brain and nerve substance, out of which it was first prepared by Liebreich, as well as from the decomposition of lecythin with baryta water. Till quite recently it was thought identical with choline, prepared by Strecker from the bile of the pig and of the ox.

What is of interest to us in regard to neurine is its property of readily dissolving fibrin and coagulated albumen and of pre-

servicing putrefiable substances, so that it ranks partly with the group of solvents, partly with that of antiseptics. E. Ludwig<sup>1</sup> (Vienna) was the first to recommend the use of neurine in the local treatment of diphtheria, and on the strength of these observations Mauthner and many others who have experimented with it (Hauke, v. Becker, Bretzina, Kassowitz, and Winiwarter) have reported favourably as to its action. In these cases a 3 to 5 per cent. solution was painted upon the affected parts.

According to my own experience a five per cent. solution is the most effective.

### 12. *Tetramethyl Ammonium Hydroxide and Tetraethyl Ammonium Hydroxide.*

Both ammonium bases, one of which is crystallisable; the other forms a highly volatile, crystalline mass; they have a strong alkaline reaction, a bitter caustic taste, like caustic potash; they irritate the skin and saponify fat.

As Mauthner has shown, they possess the same properties as neurine of dissolving fibrin and coagulated albumen and of acting antiseptically. A three to five per cent. solution may be recommended.

More accurate investigations into the therapeutic action of these three ammonium bases in the direction indicated are still wanting.

### 13. *Succus Caricæ Papayæ L.*

The inspissated milky juice of this species of carica forms a dirty brownish-green amorphous mass, having a feeble, not very agreeable odour, and a slightly bitter, harsh, astringent taste. According to Rossbach it is insoluble in boiling water, but readily dissolves (1 : 8) in cold water; the filtered solution is clear and of a bright yellow colour.

Croupous membranes which Rossbach<sup>2</sup> treated with these

<sup>1</sup> E. Ludwig, 'On Neurine,' communication to the Medical Association in Lower Austria, No. 10, 1877.

<sup>2</sup> J. M. Rossbach, 'Papayotine, a good Solvent for Diphtheritic and Croupous Membranes.' From the Pharmacological Institute of the University of Würzburg. *Berlin. klin. Wochenschr.* xviii. No. 10, 1881.

solutions were disintegrated into very small particles in about twelve hours.

In one case treated by Rossbach the child's pharynx and larynx were painted every five minutes with a concentrated solution of the preparation and a few drops dropped or injected into the mouth. In about thirty hours the pharynx was perfectly free from diphtheritic membrane. The child succumbed to diffuse atelectasis and pulmonary œdema. No further observations are forthcoming.

#### 14. *Papayotine.*

Papayotine, the pure milky juice of the above-mentioned plant, has lately again been tested by Rossbach as to its property of dissolving coagulated albumen and fibrin which it had been stated to possess by former observers. The result of these investigations will excite great interest in this drug in connection with the treatment of inflammations of the mucous membranes with fibrinous exudation.

Papayotine is amorphous, pure white, not hygroscopic, odourless, and almost tasteless. It dissolves in water in the ratio of 1 : 20, the fluid remaining inodorous and tasteless.

When we put a piece of papayotine in the mouth and chew it (Rossbach), it is just like chewing a piece of chalk, and it has no taste whatever; it produces no alterations of any kind in the epithelium of the oral mucous membrane or in the mucous membranes themselves. Pulmonary tissue taken from a freshly killed rabbit and placed in a five per cent. solution of papayotine showed little alteration after several days, and only looked somewhat paler and shrunken.

In order to test its power of dissolving fibrinous membranes, a large piece of a diphtheritic membrane which had been coughed up by a tracheotomised child was submitted to a concentrated solution of papayotine (1 : 20). Within an hour it was disintegrated and reduced to very minute particles, and appeared only as a light greyish cloud in the bottom of the watch-glass. After another six hours this residuum was also completely dissolved, so that even under the microscope not a trace of any organic elements was to be detected in the clear

solution. On evaporation of the water a number of very fine and beautiful fascicularly and cruciformly arranged crystalline needles appeared, whose nature Rossbach could not distinctly ascertain on account of the small number at his command.

As regards the solubility of the membranes in various strong solutions, Rossbach found that portions of membrane dissolved completely in the five per cent. solution, only very partially in the  $2\frac{1}{2}$  per cent., and not at all in the  $1\frac{1}{2}$  per cent. solution.

Rossbach recommends that this remedy in a five per cent. solution, partly by painting, partly by simply letting a few drops trickle into the mouth and the nares (not only in nasal diphtheria), should be brought into contact with the membranes every five minutes regularly, allowing intervals of an hour or two to elapse between the applications.

For inhalations, as it is necessary to use the saturated solutions which contain only five per cent. of papayotine, we must make use of apparatus constructed on Bergson's principle, because in the steam spray producers the solution is diluted by about half its percentage of steam, and thus its energy considerably reduced.

I would earnestly recommend the combination of carbolic acid inhalations with this drug in diphtheria of the larynx and of the deeper air passages after tracheotomy (vide infra, Diphtheria of the Deeper Air Passages).

## 6. STIMULATING ALTERATIVE, ANTISEPTIC, AND ANTIPUTRESCENT REMEDIES.

*Mode of Action.*—The influence which these medicines exert upon the mucous membrane of the respiratory organs, with which they come into direct contact by inhalations, is—

(a) A stimulating influence tending to excite inflammation, and in proportion to the degree of irritation they cause they will more or less alter the processes in course of development.

If this influence be sufficiently prolonged, they in the first place induce hyperæmia in the parts with which they come into contact. A more copious flow of blood takes place into the superficial capillaries, and their engorgement afterwards spreads

to the deeper vascular regions. With the increased flow of blood an increase of temperature is observable, which may amount to a feeling of heat in the trachea or other affected parts.

Next follows an augmented extravasation of serous fluid and cellular elements upon and within the tissues. By this means tissue change is actively promoted in these parts; their nutrition is energetically stimulated and strengthened. Similarly, as the afflux is increased, so the efflux by the lymph spaces and the lymphatics and blood vessels will be also quickened. The saturation of the tissues with fluid and its freer efflux induces, together with the temporary swelling of the parts, a thorough irrigation which sets free the inert and stagnant accumulations of blood and plasma which have been deposited in the tissues by chronic inflammations, promotes their molecular disintegration, and carries off the products of decomposition by means of the lymphatics and blood-vessels.

The increased afflux of the blood extends also to the glands, and the secretory activity of the better nourished cells is essentially influenced and altered. Too copious as well as too scanty secretion suffers a change and may be completely restored to the normal condition. If the inflammatory irritation which the application excites upon the mucous membrane is excessive, the secretion may cease altogether, and actual inflammatory symptoms be superinduced.

At the same time these remedies, according to their chemical nature and composition, will act more or less on the constituents of the tissue and the products of secretion with which they come into contact, modifying or arresting the processes at work in them, and forming new combinations with the several elements or products of decomposition. Thus these substances, in addition to their stimulating, exciting, alterative influence, will exert an analogous action to that of antiseptics and antiputrescents.

Lastly, these agents, if they are inhaled in sufficient strength to exercise an adequate influence upon the mucous membranes, produce an excitement in the several nerve tracts, and arouse central reflex movements.

(b) Where fermentative and putrefactive processes are at work, a number of substances belonging to this group, when

brought in sufficient quantity into contact with the substances in course of decomposition, have the effect of chemically arresting these processes partially or wholly, or of exerting a modifying influence upon the decomposing matter.

According as organic ferments or vegetable organisms, such as putrefactive fungi, are the excitants of fermentation, these agents will, either by oxidation or reduction of the products of disintegration, or by destroying the vitality of the putrefactive organisms, arrest the further progress of the decompositions and transfer the disintegrated bodies into other combinations. Thus they destroy the injurious products to which these decompositions give rise, and which, when introduced into the human body, produce hurtful effects; and again, by destroying or limiting the vitality of the vegetable ferments, they prevent these organisms entering the interstices of the tissues, into the lymph-spaces, the lymphatics, and the blood-vessels, propagating there and giving rise to fresh decompositions.

By the arrest of these processes and destruction or alteration of their products, the establishment of energetic reaction in the diseased tissue will be more and more promoted, while it is gradually withdrawn from the deleterious influence of these processes, and demarcation and detachment are facilitated. Where gangrenous masses have been detached and favourable suppuration has been set up, they will prevent the infection of the pus by products of decomposition and vegetable organisms, and will establish conditions most favourable to the formation of cicatricial tissue and eventual healing.

Lastly, by the arrest of the putrescent processes and the transfer of their products into other chemical combinations, the development of gases, and the passage of other volatile substances into the air cease, and the fœtid odour which attends these processes, and may be perceived more or less unpleasantly even at some distance, disappears.

*Indications.*—A. *Employment of these medicines as stimulants and alteratives.*

1. In cases in which the *mucous membrane* of the respiratory tract is *ill nourished* and *anæmic* in connection with chlorosis, scrofula, chronic infiltrations of the lungs, and after emaciating illnesses, such as typhus, pneumonia, and diphtheria.



In these diseases *chronic catarrhs* are set up which have an *anæmic* character, and the cases in which they occur are in themselves but little accessible to treatment, a general state of mal-nutrition having already made steady advance. The mucous membrane, in consequence of the scanty supply of blood, is pale and colourless, and frequently at the first glance its appearance does not convey the impression of a catarrhal affection. The secretion is scanty; thinnish mucus is expectorated, generally in small, occasionally in large quantity, or the sputa consist chiefly of pus corpuscles or young ill-developed epithelial cells, which are secreted in considerable quantity from the surface of the mucous membrane.

The inhalations of these substances exert a stimulating and invigorating influence upon such mucous membranes, and the hyperæmia which they induce creates the material for more energetic tissue-change and greater activity in cell-formation. General improvement of the nutrition and sanguification alone will not cure this kind of catarrh, and yet the failure of these processes is the indication for local treatment, and in incurable cases, as in incipient phthisis, these stimulating measures will at least maintain as long as possible what can be maintained.

2. *Chronic catarrhs of the larynx, the pharynx, and the bronchi.* (a) *Of a torpid character.* These catarrhs have generally been developed under the protracted influence of hurtful conditions and repeated acute exacerbations; the mucous membrane is much swollen and discoloured, from a certain amount of venous hyperæmia; its surface is moist and glazed, covered in parts with glutinous, viscid, often puriform mucus, which is sometimes expectorated with ease, sometimes with difficulty. At the same time the voice is rough and hoarse, the cough is usually violent, full, with a dry ring and produced with very strong expiratory efforts, and it frequently happens that only a little glutinous phlegm is expectorated after a number of violent fits of coughing. Painful sensations, such as tickling, burning in the throat, feeling of soreness, may be entirely absent, and only make their appearance from time to time during intercurrent acute catarrhs, when they come on violently.

(b) Associated with *blennorrhœa* of the *mucous membrane*.

Many of these substances, from their influence in checking secretion, are adapted for inhalation in blennorrhœic conditions of the trachea and of the bronchi, also in hypersecretion of the glands of the larynx.

In consequence of the hyperæmia and the increased transudation which the action of these remedies produces on the usually much swollen and softened mucous membranes, the secretion is at first augmented, the expectoration facilitated, and the cough thus diminished. After some time, however, the quality of the secretion is altered. It becomes more consistent and richer in cells, while it diminishes in quantity; at the same time there is no difficulty of expectoration, no feeling of oppression, fulness of the chest, dyspnœa, or asthmatic conditions from accumulation of secretion in the air passages and consequent obstruction of the finer bronchi.

When the cause of chronic bronchitis can be removed by changing the mode of life or occupation, and when we can remove our patient from the continued action of deleterious influences upon the respiratory organs, such as the inhalation of dust and other mechanically or chemically irritating substances, which give rise to these catarrhs, then we may hope to effect a complete cure of the disease by the prolonged use of stimulating and alterative remedies with other suitable prescriptions. Where the disease, however, is due to a deeper-lying affection, such as emphysema with bronchiectasia, pulmonary phthisis, or cardiac diseases with valvular insufficiency, these remedies, as I have repeatedly convinced myself, are far more effectual as palliatives than the so-called internal remedies so commonly employed, which, absorbed from the stomach and intestine, are supposed to act through the blood and the nerves upon the pathologically altered mucous membranes. These remedies always improve matters for a longer or shorter time, and a disease in itself incurable is at least made more tolerable.

3. In *atonic ulcers* in the larynx and in the deeper air passages, in bronchiectasia as the result of interstitial pneumonia, emphysema, and tuberculosis, where there is no tendency to hæmorrhages, the direct stimulating action of these vapours induces a vigorous circulation of the fluids in the tissues, and an increased activity in cell-formation, just as in atonic ulcera-

tions of the external parts stimulating ointments and compresses promote a favourable suppuration, under which, if the possibility is afforded, cicatrisation may take place (Pagenstecher's ointment, dusting with calomel, &c.)

These remedies exert an alterative effect upon the walls of the ulcerated and dilated bronchi, on their contents and on their secreting surface. The increased flow to the part of nutritive fluid promotes the development of more permanent tissue and cells of greater vitality, so that by this means disintegration is arrested and limits are to some extent set to the destructive process. By the disinfecting and antiseptic properties which these substances also possess, they modify the processes of decomposition and putrefaction in the contents of bronchiectatic dilatations and cavities, and thus prevent the formation of corrosive or ichorous fluid and check the further spread of ulcerative and septic processes.

In consequence of this action the remedies under consideration are also indicated in other cases in which cure is impossible, and in which disintegration of the tissue and decomposition of the products of disordered secretion rapidly lead to the deterioration of the patient locally and generally. These are especially—

4. *Carcinomatous* growths in the larynx and the upper part of the trachea, when, owing to the occurrence of rapid disintegration of tissue, there has been no urgent indication for tracheotomy, or where the operation has had to be performed owing to the rapid growth of the tumours. If disintegration of tissue and ichorisation spread rapidly and extensively, still stronger disinfecting antiseptic and antiputrescent agents will have to be employed, so far as the general condition of the patient will allow.

5. *Pulmonary Gangrene*.—What we have already said of the properties of stimulating vapours shows that they are theoretically indicated in pulmonary gangrene. The increased flow of blood affords the possibility of promoting changes in the tissues and of exerting a capacity of reaction, which in the diseased parts has become almost extinguished; while their chemical action on the parts that are wasted and breaking down on the one hand promotes a demarcation and separation of the

gangrenous from the still healthy pulmonary tissue, on the other, by disinfection, or by altering the nature of the decomposing processes at work, averts the danger of absorption of ichorous infective substances and the development of general sepsis. In this case practice has been in advance of theory, or rather the theory has been evolved in seeking an explanation of the discovered facts. (V. infra, Pulmonary Gangrene.)

6. Lastly, when the predominant influence of these stimulating remedies is exercised over the tissues and the terminations of the sensory nerves, they will produce a certain amount of nervous excitement and rouse reflex movements. The inhalation of these remedies has therefore been tried in disturbances of innervation and more especially in *paresis* and *paralysis* of the *laryngeal muscles*, of a hysterical or rheumatic origin. The effect here is of a twofold nature, first, especially in rheumatic cases, from the augmented flow of lymph resulting from the rapidly developed hyperemia and the consequent increased activity in tissue-change, usually also of much importance in those cases of chlorosis or hysteria in which the laryngeal muscles are pale and ill-nourished; and secondly, owing to the strength of the reflex movements excited, whereby the muscles affected are roused to powerful contractions.

B. *Application of disinfecting and antiseptic substances.*  
In the following cases:—

1. *Destructive Processes in the Pharynx and Larynx*, especially when ulcerations have been established and have led to more or less loss of tissue.

As these cases, especially laryngeal ulcerations, are usually complicated with more or less diffused bronchitis or chronic pneumonia or pulmonary phthisis, we almost always find adhering to the somewhat raised, uneven, callous margins of the ulcers some of the expectoration from the bronchi and cavities, containing muco-purulent or purulent debris, perhaps already in a state of decomposition, which when exposed to the air suffers further decomposition, chiefly by the admission of bacterial germs. The immediate result of this is always an extension of the base of the ulceration, which, from contact with the eroding fluids, assumes a malignant appearance and soon shows signs of rapid loss of substance. By energetic local

treatment of the ulcerations, by means of disinfecting and antiseptic inhalations, we may in most cases limit the rapidly advancing destruction and promote healing, if healing be possible.

2. *Diphtheria*. — The method of applying antiseptic remedies locally in diphtheria has been long employed, and, till quite recently, it has been repeatedly recommended and used with more or less success. The contagium which develops in the mouth of the patient, especially when it reaches a suitable soil, such as the mucous membrane seems to offer, continues to propagate the disease, and therefore renders necessary a thorough disinfection of this cavity, to ensure in the first place that the disease shall have as little opportunity as possible of further dissemination by infection, but secondly and chiefly because the disease spreads through the mouth by the parasitic proliferations of the micrococcus diphthericus itself, which is peculiar to this affection. Lastly, the proliferations of this fungus and the accumulation of fibrinous exudations resulting from the inflammatory process tend to develop destructive septic and putrescent processes, which must be encountered by an energetic application of disinfecting and antiseptic remedies.

3. *Fœtid or Putrid Bronchitis*. — Fœtid expectoration occurs in simple dilatation of the bronchi, and sometimes even when there is no dilatation at all, as well as in cases of cystiform bronchiectasiæ, since the secretion of the bronchial mucous membrane is liable under certain circumstances to undergo putrefactive changes. According to Lebert it may arise under a variety of conditions, primary and secondary; it may be accidental and temporary in ordinary bronchitis and pneumonia, or it may form the only differential character of a special form of bronchitis; or, finally, it may occur as a complication in bronchiectasia, broncho-pneumonia, and tuberculosis. According to the observations on record (Leyden, Riegel, and others) antiseptic and antiputrescent remedies act more rapidly and more surely in these cases than the more stimulating and alterative ones, although these also, in the manner we have already described, will exercise a favourable influence (Skoda). If the symptoms of decomposition and putrefaction have to a great extent disappeared, then we must substitute stimulating, altera-

tive inhalations of oleum terebinthinæ, of tar or of balsamic substances, so as to exert a stimulating effect upon the vessels and the glandular apparatus of the mucous membrane; subsequently by means of alkaline and saline solutions the bronchi must be completely freed from the secretions, and finally, by means of astringents, we must get rid of the last changes which the bronchitis has wrought on the mucous membrane, viz. swelling and softening of the tissue and other hyperæmic states.

4. *Bronchiectasiæ and Cavities.*—The contents of bronchiectasiæ and cavities are also prone to putrefactive decomposition, and give rise to symptoms analogous to those of fœtid bronchitis. Here also the indication for the application of antiputrescent and antiseptic remedies is as clear as in the former malady, although the result is not so favourable, for we can only expect to arrest the putrefactive processes in these cavities, and to avert general septic infection or secondary pneumonia, dangers which these processes threaten. A counter-indication, which would make the prognosis of the case far more grave, would be the danger of hæmorrhage, which might call for the substitution of styptic for septic remedies, specially the liquor ferri perchloridi, or a combination of antiseptics with ferric chloride might be employed.

Again, on the occurrence of empyemæ and the commencing putrefaction of the contents, an attempt should be made by means of disinfecting inhalations at least to get rid of the putrescent masses adhering to the bronchial walls and their dilatations and to diminish as much as possible their destructive and corrosive action. This plan of treatment, together with keeping up the strength of the patient, is most urgently indicated, and is, from a pathological point of view, the most rational.

5. *Pulmonary Gangrene.*—Even when shreds of parenchyma, fragments of destroyed lung tissue, are found in the fœtid sputa, and thus it is evident that it is no longer a case of fœtid bronchitis only, but one of gangrene of the pulmonary parenchyma, these inhalations will constitute the best method of treatment, and the inhaled substances which come into direct contact with the diseased part will exercise a disinfecting in-

fluence upon it. For reasons already given these remedies may be either combined with or substituted for the stimulating alteratives, and we need not be afraid that the stimulation which they exercise upon the parenchyma of the lungs will influence injuriously the reactive inflammation in the vicinity of the gangrenous focus. Moreover antiseptic inhalations, if they can be borne in sufficient concentration by the patient, will produce a stimulating and reactive effect, and thus promote demarcation and separation of the gangrenous masses. Lastly, it is not till after complete separation and discharge of the gangrenous masses that we should substitute for these, in order to further stimulate the tissue, the aromatic medicines which exert a gently exciting influence and counteract the offensive smell, by which means also we avoid the unpleasant smell and taste of stronger antiseptic media, which are objected to by many patients.

6. *Pulmonary Phthisis*.—Disinfecting antiseptic treatment is urgently indicated in all advanced forms of phthisical and tuberculous disease of the respiratory organs. Even if we decline committing ourselves to the parasitic theory first put forward by Klebs, the truth of which, however, is extremely probable, still the mycotic processes which arise in the larynx, bronchi, and lungs, in these diseases, are so inevitable, and generally of such intensity, that they now have the strongest claim on our attention. In the treatment of the most simple wound or external ulcer we cleanse them with the most scrupulous care and apply antiseptic dressings, while in this frightful disease the whole surface of the respiratory tract is covered with decomposed secretions, septic pus, and with milliards of fermentative bacteria, which may exercise unhindered that influence over extensive tracts of the most vital organs which we try earnestly to avert from the slightest wound.

A part of our task in the treatment of pulmonary phthisis is to check these processes, and we have no better means of doing this than the energetic use of disinfecting and antiseptic methods by means of the inhalation of the vapours and pulverised solutions of these agents. By reducing these injurious processes we shall always be able to confine the disease itself, or rather the complex pathological processes of which it consists,

within narrower limits, and to lessen their influence upon the diseased organism as much as possible, even though we have not hitherto succeeded in assailing the disease itself in its essence by any kind of therapeutic treatment.

#### MEDICINAL SUBSTANCES.

##### a. STIMULANT AND ALTERATIVE REMEDIES.

##### 1. *Tar (Pix Liquida).*

Although tar was employed in ancient times in angina by Archigenes, its local application in the form of fumigations in diseases of the respiratory organs was first recommended in the last century by Rush, of Philadelphia, who was accidentally led to adopt this mode of treatment by observing the recovery of a phthisical patient while employed in tar works. It was, however, through the labours of Crichton that tar fumigations obtained general acceptance. After Crichton observed, on the one hand, that in his own case the vapour arising from boiling tar, while it made his eyes smart, rendered his breathing much more easy, and, on the other hand, that men who were constantly employed among tar vapours very rarely suffered from phthisis, and that those who were troubled with chronic cough lost it as soon as they took up any occupation connected with the vapours of tar, he tried inhalations of tar as a remedy in diseases of the respiratory organs, and with such success as soon drew general attention to this system of treatment.

The first effect of breathing tar vapours is a troublesome headache with some dyspnœa and a slight aggravation of the cough. If at the same time there is suppression of expectoration, the treatment must be suspended, lest the vapours should cause inflammatory irritation of the bronchial mucous membrane; if, on the other hand, the expectoration increases, a favourable issue may be expected with gradual decrease of the cough, of the expectoration, and of analogous symptoms of pulmonary phthisis. Crichton recommends tar inhalations in the first stage of laryngeal phthisis, in congestive pulmonary phthisis, inflammation of the lungs, in chronic bronchitis, and more especially in bronchorrhœa.



We are now able to employ inhalations of tar in two ways, either in the form of vapour, as originally used by Rush and Crichton, or in the form of tar water pulverised by an apparatus for the purpose.

(a) The following is the most simple and effectual manner of employing tar fumigations:—

Take good ship's tar, and, by the addition of about 10 per cent. of carbonate of soda, neutralise the ligneous acid contained in it, which on evaporation would act as an irritant upon the bronchial mucous membrane and the lungs. It is best at the commencement to dilute this tar mixture with water, so that we may at the same time get the advantage of the emollient action of aqueous vapour on the parts affected. Later on, if the patient bears the inhalations well, and no inflammatory symptoms appear, the amount of water may be gradually reduced, and at the last the pure tar mixture, treated with soda, may be used, simply poured on to a flat dish and heated to boiling over a spirit lamp.

The vapours are evolved in the vicinity of the patient for a quarter of an hour or more at a time, once or twice a day, according to the peculiarities of the patient, while he should remain all day in a room impregnated with tar vapours. So long as the tar remains fluid whenever it is heated, it may be used over and over again, but as soon as it becomes tough and thick it must be renewed.

Inhalation of tar vapours may also be simply and conveniently carried on for any length of time by means of the medicated respirator, in which case 1 to 6 drops of neutralised tar, according to the effect desired, are dropped on cotton wool and introduced into the receiver. Tar ointment, prepared in the proportion of 1 : 4, may also be used for the same purpose, smeared in small quantities on cotton wool (Hausmann). The patient must wear the tar-impregnated respirator for several hours in the morning and afternoon, in order that the respiratory mucous membrane may be submitted for a sufficiently long time to the action of the tar vapours.

(b) *Tar Water*.—For the local application of tar by means of the pulverising apparatus, tar water is mixed in different percentage proportions with water; solutions of 5 to 10 or 50 per cent., or pure officinal tar-water, may be pulverised in an

apparatus and inhaled. This is at present the simplest and handiest way of applying tar, if the action of water seems desirable at the same time for the dilution of putrid secretions.

According to the observations recorded tar and tar water exert partly a desiccating action on the mucous membrane, and diminish the secretion, and act partly as antiputrescents in the case of decomposing, excessively foetid secretions, and Siegle terms tar water an antiseptic *par excellence*.

Its use is therefore indicated in all affections of the mucous membranes of the respiratory organs, attended with augmented secretions, which are exposed to decomposition; therefore in bronchorrhœa and bronchiectasia, putrid bronchitis, pulmonary gangrene, and pulmonary phthisis, in the stage of softening as well as in the profusely secreting cavities which succeed this stage.

If the remedy is applied in gradually increasing doses the result is a reduction of the hitherto profuse secretions, without any difficulty of expectoration or inflammatory irritation and hæmoptysis; at the same time the processes of decomposition are arrested, and the foetid odour disappears. Waldenburg, with whose opinion I entirely coincide, considered that the small doses prescribed by various authors were insufficient to produce the widespread effect aimed at.

## 2. Oil of Turpentine (*Oleum Terebinthinæ Rectif.*)

In form of vapour and suspended in water 0·1 to 0·5, 2·0, or 4·0 per cent.

Oil of turpentine was used in very remote times as a local remedy in pulmonary affections, and its value was attested by the wholesome influence which residence in pine woods exercised upon sufferers from chest complaints, as mentioned even by Pliny.

It is well known that fumigations with pine cones and chips of different species of fir were employed by the ancients (Pliny, Antillus), but also in modern times Billard, Copland, and others have successfully used fumigations derived from compounds of wax, turpentine, and various resins in bronchitis and pulmonary phthisis.

Turpentine inhalations attained a wide celebrity through

Stokes, who prescribed inunctions with a liniment of oil of turpentine and acetic acid over a large surface of the chest in the case of patients suffering from bronchitis and phthisis. By this mode of application firstly an erythematous condition of the skin was produced, which had a revulsive effect, and secondly the atmosphere which the patients inhaled was permanently filled with vapours of the oil of turpentine. Snow also observed diminution of cough and expectoration in phthisis under the influence of inhalations of oil of turpentine.

In Germany Skoda greatly popularised turpentine inhalations, and drew universal attention to them by curing a case of pulmonary gangrene by this method. Skoda administered inhalations of oil of turpentine with a Mudge's apparatus, or he placed the patient in a tub in which was placed at the same time a vessel of boiling water into which a few spoonfuls of oil of turpentine were poured; the tub and the patient in it were then covered up with a linen cloth, so that the patient inhaled uninterruptedly the air saturated with vapours of oil of turpentine and water.

Another method which he suggests is more convenient, i.e. charging the atmosphere of an air-tight room with such vapours, which offers the additional advantage that the patient may spend not only a short time but whole days in the atmosphere, and thus continue his occupation without the smallest inconvenience. Skoda has recommended turpentine inhalations not only in pulmonary gangrene, but also in laryngeal and tracheal catarrhs, in paralytic aphonia, and even in pulmonary phthisis. From that time oil of turpentine has been employed with favourable result in all cases where it was indicated.

The administration of vapours of oil of turpentine is conducted either in the manner advised by the above-mentioned authors, or, as I frequently prescribe it, by pouring 10 to 12 drops of oil of turpentine into a vessel in which pure water or water treated with aromatic herbs is heated to boiling point, and causing the vapours thus evolved to be inhaled by means of a funnel-shaped pasteboard contrivance. The inhalations must be repeated 4 to 6 times a day, and prolonged often for 6 to 10, 15, or 30 minutes at a time.

If a few drops of oil of turpentine are introduced into water

and shaken up several times, so that a part of it remains in suspension, such a mixture may be pulverised by the pulvérisateur and used as an inhalent. Solutions of other substances which have a resolvent or astringent influence, such as common salt, sal ammoniac, alum, &c., may also be combined with oil of turpentine in these suspensions, in which case the combined effect of both remedies is experienced by the respiratory mucous membrane and the secretions adhering to it.

Continuous inhalations of oil of turpentine are best carried out by means of the medicated respirator, which, after 10 to 12 drops of oil of turpentine on cotton wool have been introduced into its receiver, may be worn for hours during the day or the whole night.

Inhalations of oil of turpentine appear to act as follows:—

1. They diminish the catarrhal disposition of the laryngeal and bronchial mucous membrane consequent upon chronic catarrh, emphysema, and asthma, and at the same time exercise a favourable influence upon the catarrhal affections themselves.

2. They diminish, as tar preparations do, the excessive secretion in the bronchi in cases of bronchorrhœa and chronic bronchitis, and exert a stimulating influence upon the sensory nerves of the respiratory mucous membrane, which on the one hand influence the secretory activity of the glands, and

3. On the other stimulate reflex movements (paralytic aphonia, Skoda); and lastly

4. They exercise a marked antiputrescent influence on decomposing and putrefying secretions and destructive processes in the bronchi, in bronchiectatic cavities, and in liquefying processes and gangrene of the pulmonary tissue, as Skoda first demonstrated.

An agency analogous to that of oil of turpentine, only weaker, is exercised by oleum pini sylvestris, oleum pini pumilionis, oleum juniperi e bacc., oleum cadinum, while their odour is more agreeable and is better borne by many patients. The doses of these substances are higher than those of oil of turpentine.

Fieber has found the infusum turionum pini (30·0 to 100 filtration) to be efficient in a case of irritative cough attended with abundant secretion, while Wistinghausen administered inhalations of extractum turionum pini.

3. *Balsams*—*Balsamum Peruvianum*, *Balsamum Tolutanum*, *Balsamum Copaivæ*.

Balsams act in the same manner as oil of turpentine and olea pini (Köhler) on the respiratory mucous membrane; when their vapours, either in the form of fumigations or mixed with water, are inhaled, they diminish secretion, promote expectoration, and are to some extent disinfectant.

In antiquity and in the Middle Ages fumigations of galbanum, ammoniacum, myrrhæ, benzoin, &c., were very much used in diseases of the respiratory organs, especially in bronchorrhœic conditions, as in phthisis, because they considerably diminished the amount of secretion from the bronchial mucous membrane. Thus Billard used a fumigation of a mixture of yellow wax and resin. M. Solon employed the balsams in combination with aqueous vapour; he used the tincture of benzoin or balsam of Tolu with the steam of hot water or an infusion of aromatic herbs, and so formed emollient balsamic inhalations.

Nowadays the balsamic remedies are almost wholly superseded by ethereal oils. Quite recently M. Schmidt has returned to the use of inhalations of vapours of Tolu and copaiva balsam combined with aqueous vapours in phthisical ulcerations of the larynx and of the trachea, and has derived good results from them.

The active constituent of these balsams seems to him to be benzoic acid, but his patients could not endure inhalations of pure benzoic acid with aqueous vapours. For balsamic inhalations Schmidt uses 10 to 12 drops of a mixture of balsam of Peru, &c., with spirits of wine in the proportion of 2 : 1, which is added to half a litre of camomile tea, and is kept boiling by a spirit lamp. Some chloroform may be added in cases of violent irritative cough. The vapours can be inhaled through a conical roll of paper  $\frac{3}{4}$  of a yard long, the larger lower end covering the vessel and the opposite end having an opening large enough to admit the mouth. The patient inhales 3 to 4 times a day for 5 to 15 minutes at a time.

An aqueous infusion of balsam of Peru may also be prepared, and inhaled through a steam spray-producer. 5 grms. of balsam

are mixed with 200 grms. of boiling water and left to stand half an hour, shaking frequently; in this way a watery solution of benzoic acid is obtained.

The *mixtura oleoso-balsamica* v. *balsamum vitæ Hoffmanni* was composed of three parts *balsamum Peruvianum*, one part *oleum lavandulæ*, *caryophyllorum*, *cinnamomi*, *cassiæ*, *thymi*, *citri*, *macidis*, *florum aurantii* to 240 parts of spirit, and was given in combination with spirits of wine or a solution of gum, 0·2 to 5·0 per cent., in *emphysema* and *asthma*. Their action on the mucous membrane and its secretion, as well as the indications for their use, are the same as in the case of tar, oil of turpentine, phenol, and the other alterative and antiseptic remedies.

Lastly, it is possible to apply balsams in the form of pulverised fluid if they are mixed with a thin solution of gum, 2 to 5 per cent. of balsam, with half as much gum arabic, in bronchorrhœic conditions and for the disinfection of secretions. Still for both purposes they are inferior to the vapours already mentioned, if it were only on account of their form.

#### b. ANTISEPTIC AND ANTIPUTRESCENT REMEDIES.

##### 1. *Chlorine (Chlorum)*.

The use of chlorine for inhalations in pulmonary phthisis was first suggested by Cannal, in the year 1818, in a *mémoire* presented to the Academy of Medicine in Paris, in which he advocated inhalations of chlorine as a remedy for diseases of the respiratory organs, and in particular for pulmonary phthisis, founding his theory on the fact that phthisical subjects found relief during their employment in bleaching factories, in which chlorine vapours accumulate.

Here again we have a series of authors who lay claim to startling successes in treating phthisis with chlorine. But later observations (Rayl, Little, Morton), and especially Toulmouche's experiments with the inhalation of chlorine, furnished contradictory results and proved the delusive character of the former observations. Toulmouche never succeeded in effecting a cure in pronounced pulmonary phthisis; although in almost all cases a temporary improvement might be traced to the

chlorine inhalations, expectoration was facilitated, the excretion became more natural, and the appetite was improved. Patients could not long support this treatment, for it set up a burning sensation in the larynx and a feeling of dryness in the chest attended with cough, and they succumbed to the complaint in a longer or shorter time. On the other hand Toulmouche obtained more satisfactory results from the application of chlorine vapours in acute and chronic bronchial catarrhs, and according to a tabulation of 141 cases of acute bronchial catarrh the great majority were cured in 5 to 6 days, the minority in 11 to 15 days, while in 65 cases of chronic catarrh, 17 of which were double-sided and 4 complicated with emphysema, recovery occurred in 16 to 30 days, with two-thirds of the patients in 25 to 27 days.

Toulmouche employed for his inhalations a wide-necked flask, into which, by means of a doubly-perforated cork, two glass tubes were introduced at different depths. The one, which opened below the surface of the fluid contained in the flask, served for the passage of the air; the other, which terminated a little below the cork, was fitted with a mouth-piece, suitable for the inhalation of the vapours generated in the flask. The flask itself was one-quarter filled with hot water, to which at first 10 drops of chlorine water were added, and then gradually increased up to 30 and 40 drops; the patients inhaled 6 times a day from 10 to 15 minutes at a time.

Stokes was the most decided opponent of the treatment of phthisis with chlorine inhalations, and repeatedly states that he never witnessed any but mischievous results from them in this disease; fresh symptoms of irritation in the lungs, pain in the side, oppression at the chest, sudden loss of appetite, diarrhoea, and sopor were frequently the immediate results of this treatment. On the other hand, Stokes has recorded a case of gangrene of the lung in which rapid improvement followed close upon chlorine inhalations, the foetid odour disappeared within two to three days, returned while the chlorine treatment was suspended, but was completely removed by its renewed application. Louis's later observations in more than fifty cases of phthisis fully coincide with these conclusions; in not one single case did he witness a successful result from this treatment.

Maddock alone thought he had found in chlorine a signal remedy for phthisis, but his statements met with no confirmation from any quarter.

Nowadays chlorine, and especially chlorine water, which is an energetic antiseptic and has been repeatedly tried in putrid bronchitis, is never used for inhalations, since its influence upon the respiratory organs is too irritating; perhaps, however, it might be employed in a highly dilute form in bronchial affections; in pulmonary gangrene its irritant properties are much more to be feared (Waldenburg). Since, in all indications suggesting treatment with chlorine inhalations, there is no difficulty in substituting not only more harmless, but infinitely more effectual and thoroughly tested remedies, we may for the present dispense with its use altogether, and employ in its stead oil of turpentine, carbolic acid, &c.

## 2. *Bromine (Bromum).*

The action of bromine on the animal tissues and on organic compounds generally depends, like that of chlorine, on its strong affinity for hydrogen, which it abstracts from its organic molecules and unites with, forming hydrobromic acid, in which process the structure of the original molecule is destroyed. According to an observation of Glower bromine appears also capable of chemical combination with the albuminates.

As bromine evaporates at ordinary temperature it has been lately made use of in inhalatory therapeutics, especially as an antiseptic. A sponge is saturated with a 0.2 per cent. solution of bromine and bromide of potassium, placed in a cone of strong pasteboard and held over the mouth and nose of the patient as in chloroforming. The inhalations should last five to ten minutes and be repeated hourly and half-hourly.

The action of bromine was tried in diphtheria and croup, and, according to some reports, it exercised a specific influence on these diseases, but these observations have not as yet been fully confirmed. It exerts an inflammatory and corrosive influence upon the epidermis and the mucous membrane, and incautious inhalations may lead to pharyngo-laryngitis, tracheitis, and bronchitis, as well as to spasm of the glottis.



### 3. *Boracic Acid (Acidum Boricum).*

In 2·0 to 4·0 per cent. solutions.

Boracic acid acts in the same manner as carbolic and salicylic acid, as will be mentioned farther on, and is more or less valuable in almost all cases in which they are employed.

It has been recommended in various quarters as almost a specific in diphtheria, but I have convinced myself that it is not more effectual than the other acids just named.

It appears to be indicated in similar processes as these preparations, as in ulcerative laryngitis, putrid bronchitis, and bronchorrhœa, bronchiectasia, and pulmonary phthisis. The strength of the solutions is given above.

### 4. *Potassium Permanganate, Crystallised Permanganate of Potash.*

In 0·1 to 0·2, 0·5, or 1·0 per cent. solutions.

Potassium permanganate is an exceedingly powerful oxidising agent, and by giving up part of its oxygen destroys most organic bodies, passing itself into a manganese monoxide salt.

In strong solutions it has an inflammatory action on the mucous membrane, causing long-continued burning pain; still more highly concentrated it exerts a corrosive influence.

Fermentative and putrefactive processes are arrested by it, partly by its destructive action on the organic ferments and putrefactive fungi, and partly by destroying the putrefying compounds; in gangrenous, ichorous ulceration it not only arrests the destructive processes and acts as a deodoriser, but it also acts as a stimulant upon the floor of the ulcers, improves their aspect, and promotes healing. In its antiseptic and antiputrescent influence it stands next to carbolic acid, as a disinfectant next to chlorine.

Potassium permanganate has been used in diphtheria, in aphthous processes, in fœtid breath, in pharyngeal and laryngeal ulcers with offensive secretion, in putrid bronchitis and pulmonary gangrene, and lastly in whooping cough. An

unpleasant secondary effect of the substance is that when used for a long time it produces brown discoloration in all objects that come into contact with it, as the epidermis, the mucous membrane, and the teeth; consequently in most cases other remedies which have a similar effect should be used in preference.

##### 5. *Benzol, Benzene (Benzinum).*

Benzol is the hydro-carbon from which the whole group of aromatic compounds are derived. It is obtained by igniting various organic bodies to red heat. It is a colourless liquid, boiling at  $80^{\circ}$  to  $82^{\circ}$  C., crystallising at  $0^{\circ}$ , refracting light powerfully, highly inflammable, soluble in alcohol and ether, insoluble in water.

What constitutes its medicinal value and makes it suitable for inhalation is its antifermentative and antiparasitic action (Regnal, Milne-Edwards, Naunyn).

A few drops of benzoin were sufficient to arrest fermentation in a 1 per cent. solution of dextrose, in which yeast fungi had been sown, while the fungi themselves under the influence of the benzoin shrivelled up and were reduced to a granular mass, and after twenty-four hours the solution contained the same amount of saccharine contents. According to the investigations of Snow, Simson, and Nunneley, benzol has also an anæsthetic influence, by which it arrests reflex movements. Inhaled in large quantity it provokes muscular tremors and convulsions, noises in the head, and ultimately insensibility.

Inhalations of benzol have been administered in abnormal destructive changes of the secretions in catarrhal affections of the bronchial mucous membrane, in bronchorrhœa, putrid bronchitis, and pulmonary phthisis, in which its anti-fermentative and germicide properties are of value. It has also been recommended in whooping cough, on account of its anæsthetic and antispasmodic influence, and has been applied with more or less success in the different stages of that complaint.

The mode of application of benzol is simple, on account of its ready volatility; it may either be placed in open dishes in the sick room in the vicinity of the patient, or from 20 to 30 drops to a teaspoonful may be dropped on a large flannel or

linen cloth several times a day, and wrapped round the patient. The medicated respirator may be very conveniently employed for benzol inhalations, by dropping the benzol on sponge or cotton wool in the receiver. By this method a more energetic and more continuous effect is obtained than by any other.

#### 6. *Creosote, Creosote Water (Creosotum, Aqua Creosoti).*

The action of creosote is in every respect analogous to that of carbolic acid, to which it is quite equal in anti-putrefactive properties. But, as its composition is uncertain, and as it is therefore more difficult to estimate its effect and its doses, it is better to substitute carbolic acid for creosote in cases in which the latter is indicated.

Reichenbach recommended the inhalation of creosote in pulmonary phthisis, and Martin Solon and Miquet found that under the influence of creosote inhalations the cough was lessened, expectoration facilitated and altered, the watery sputa becoming thicker and exchanging their purulent, nummular character for that of a homogeneous, ropy, frothy, mucus. Junod ordered a small glass filled with creosote to be placed by the bedside of the patient, which was to be uncovered from time to time, or else a few drops dropped on a piece of linen and allowed to evaporate in the vicinity of the patient. Ebers modified the procedure in this manner; he filled a small, wide-mouthed phial, holding about ten grammes, and closely fitted with a glass stopper, three parts full with loose cotton wool, upon which ten drops of creosote were dropped; and after 24 to 48 hours four to six drops more. The aperture of the open phial was introduced into the mouth of the patient, who inhaled the creosote vapours repeatedly and as deeply as possible. In order to lessen the irritant action of the creosote vapours, Ebers in some cases added four to five drops of sulphuric ether to the creosote, or caused the creosote vapours to be inhaled together with the steam of hot water.

Creosote water contains three parts of creosote to 400 parts of water, and is generally inhaled undiluted by means of the spray-producer. Schüller tried inhalations of creosote water in artificially produced tuberculosis and in tuberculous inflamma-

tions, and obtained a retrogression of these processes. Further observations are wanting.

For permanent inhalations through the medium of the respirator inhaler creosote, as pure as possible, is dropped on sponge or cotton wool and is a valuable antiseptic and disinfectant in cases of putrid bronchitis and phthisis, in which there is a tendency to hæmoptysis (Curschmann).

### 7. Benzoic Acid (*Acidum Benzoicum*).

The vapours evolved from benzoin resin and benzoic acid, its active constituent, possess a locally stimulating and exciting influence, partly dependent on the empyrenumatic substances adhering to them in consequence of their mode of preparation. When used as inhalations, they also facilitate expectoration, diminish and ameliorate secretion, and put a check to the fermentative and putrefactive processes at work in the bronchial secretions.

On the whole benzoic acid has been hitherto but little used in diseases of the respiratory organs. Moritz Schmidt, who tried it in laryngeal and pulmonary phthisis, found the irritant effect too violent, and therefore preferred the vapours of Peruvian and copaiva balsam when the indications were similar.

Inhalations of benzoic acid are indicated in all diseases of the respiratory organs attended with the development of fungi and the decomposition to which they give rise, as chronic bronchial catarrh, bronchorrhœa, bronchiectasia, putrid bronchitis, phthisis, and pulmonary gangrene.

Benzoin resin and benzoic acid are administered in the form of fumigations, fumigating pastils, fumigatory papers, cigarettes, or in combination with the steam of hot water and that of infusions of aromatic herbs. For the last mode of application the flores benzoës and the tinctura benzoica may be used.

The composition of Roumier's fumigating pastils is as follows: carbon. vegetab. 0·5, benzoës 0·25, iod. 0·1, bals. de Tolu 0·05, natr. nitric. 0·1 (0·25 of benzoin resin contains about 0·04 to 0·05 benzoic acid).

Vix uses benzoic acid for inhalations in aqueous solutions of 1 to 5 per cent. of the officinal benzoic acid. The solution is

heated to boiling in a suitable vessel over a spirit lamp, and the vapours given off are inhaled by the patient direct from the vessel. For greater convenience the vapour may be conveyed through a leaden or pasteboard funnel, closing the vessel like a lid. It is also advisable to use a lamp with a movable wick, like a Berzelius lamp, so as to regulate the briskness of the boiling according to need, or the solution of benzoic acid may be applied by means of a steam pulverising apparatus, by introducing it into the boiler, while the little phial attached to the apparatus is either filled with ordinary water or a mineral water, or a medicated solution of benzoate of soda, of common salt, &c.; this is pulverised by the aqueous and benzoic vapours proceeding from the boiler.

A very marked antiparasitic action has been observed in the sodium compound of benzoic acid.

*Benzoate of Soda (Natrium Benzoicum).*

Klebs and Buchholz state that this salt prevents the development of putrefactive fungi even in dilutions of 1 : 2000. Graham tested benzoate of soda in the proportion of 1 : 1000 of the weight of the body in inoculation experiments with diphtheritic fungi in the cornea of rabbits, and found that it prevented the development of a diphtheritic keratitis. Schüller also found that its administration in part by inhalation in the same proportions to rabbits and guinea pigs who were the subjects of artificial tuberculosis and artificial tuberculous arthritis was attended by a complete healing of these processes in the lungs and joints.

On the strength of these experiments benzoate of soda has been since employed in large doses internally as well as by inhalation in diphtheria and other infectious diseases, sometimes with positive, sometimes with negative results. I cannot myself attribute to this remedy applied as an inhalent any very marked agency in diphtheria; it is decidedly inferior to carbolic acid, and may be regarded as of about the same value as salicylic acid, thymol, and similar medicinal substances.

This remedy obtained a rapid but unfortunately transient celebrity through Rokitansky, who, supported by Schüller's ex-

periments, applied inhalations of benzoate of soda, also in the proportion of 1 : 1000 of the body weight of the patient in pulmonary phthisis and tuberculosis, and stated that he had by this means cured this disease. Later investigations by various observers, as well as more recent ones of his own, soon proved the fallacy of these assertions (*v. infra*, Tuberculosis). As this remedy can be borne exceedingly well even in very large quantities, and 1,000 to 1,200 grammes of a five per cent. solution may be inhaled without any trace of a deleterious influence upon the lungs, it is distinctly indicated wherever a large amount of disinfecting fluid is needed for the irrigation, purification, and impregnation of extensive surfaces of the mucous membrane, ulcerative cavities, dilatations and tracts of pulmonary tissue otherwise diseased, loaded with purulent secretions, and in which the inflammatory products are undergoing decomposition and putrefaction, such as various forms of bronchitis, especially putrid bronchitis, bronchorrhœa, laryngeal and pulmonary phthisis in different stages, and to some extent in pulmonary gangrene.

The strength of the solution here advisable for inhalation usually amounts to from 5 to 10 per cent. and the quantity to 200 or 500 grammes. For the thorough cleansing and disinfection of the diseased parts, however, 1,000 grammes and even more may be required.

#### 8. *Phenol, Carbolic Acid (Acidum Carbolicum Crystallisatum.)*

Aqueous solutions of 0.5 to 5.0 per cent.

*Vapours of higher per cent. solutions and of pure crystallised carbolic acid.*

The energetic antiputrefactive, antifermentative, and antiseptic properties of phenol have led to its being largely employed in surgery, as well as in inhalations in putrid, septic, and infective processes in the respiratory organs.

Whereas chemical ferments, such as pepsine, ptyaline, emulsine, require the long action of a tolerably concentrated solution of phenol, and some even that of phenol in substance to destroy their power over albumen, starch, amygdaline, sinigrin, organic ferments are destroyed by much weaker

solutions. The bacteria and vibriones in putrescent substances, according to Lemaire, are destroyed by 0·1 per cent. solutions of phenol. On the other hand, Buchholz states that in one of his experiments it required a 0·2 to 0·5 per cent. solution to completely arrest the development of bacteria grown in artificial nutritive fluid, and a 4 per cent. solution to destroy their power of reproduction. An average of 1 per cent. of phenol is fatal to infusoria. The germinating power of spores of fungi is annihilated by 0·06 per cent. (Manassein), that of mould by 1·0 per cent. (Plugge), and yeast fungi lose their power of exciting fermentation after being acted on for twenty-four hours by a 0·2 per cent. solution of phenol. Of infective substances vaccine lymph requires 2 per cent. carbolic acid to destroy its activity (Rothe, Michelson); freshly secreted pus, whether healthy or in a state of decomposition, loses its septic action by the addition of 5 per cent. phenol, but even this strength is not sufficient with putrefactive pus; on the other hand 0·5 per cent. arrests the putrid, septic decomposition of fresh, non-septic pus (Rosenbach). According to Buchholz the alkaline fermentation of a saccharine solution is arrested by 0·476 per cent. of carbolic acid, according to Plugge by 4·0 per cent., while lactic acid fermentation is prevented by 0·377 per cent., butyric acid fermentation by 0·33 per cent. (Paschutin), and uric fermentation by 1·0 per cent. (Hoppe-Seyler).

Lastly, the putrefaction of albumen and flesh is arrested by 2 per cent. phenol (Hoppe-Seyler), and by the addition of 0·1 to 0·5 per cent. to fresh meat, blood, bread, urine, it is retarded till the volatilisation of the carbolic acid takes place (Lemaire, Plugge). Phenol exerts a deodorising as well as an antiputrefactive influence; and whereas this acid, when added to fresh albumen or meat at ordinary temperature, can be detected chemically after four weeks, when it is added to putrefying substances it can be detected only for a very short time (Bill), and this is attributable to a direct combination of phenol with a product of putrefaction.

Carbolic acid, when inhaled or administered internally, is rapidly excreted with the urine, so that there is no retention of phenol in the system and no risk of cumulative action (Sakowsky). After inhalations of phenol, in contradistinction

to its absorption from traumatic surfaces, it is not till a considerable quantity has been absorbed that a discoloration of the urine, varying from light grey and olive-green to dark brown and dark grey, takes place. After large doses, varying from a single dose of 0·5 to 2·0 grammes, taken internally, giddiness, slight stupefaction, tinnitus aurium, deafness, formication, sensation of extreme weakness, are experienced; profuse perspiration, lowering of temperature and of pulse, have also been observed, together with local effects, uneasiness in the throat, irritative cough, burning pains along the trachea and the bronchi, or, if the phenol has been introduced by the stomach especially, nausea, eructation, tendency to vomiting, and even actual vomiting. If a still larger dose be taken at one time, as 5·0 to 20·0 grammes, death may rapidly supervene, with feelings of intoxication, speedy loss of consciousness, and cardiac and respiratory failure.

Judging from the action of phenol upon fermentative and putrefactive processes and the agents which excite them, it has been tried in a series of pathological processes in the respiratory organs, which appear due to infection and putrefactive decomposition. Thus inhalations of phenol have been repeatedly administered with more or less successful results in ozæna (Ziegler), in diphtheria, in incipient laryngeal phthisis (Rothe), in bronchorrhœa, and in pulmonary gangrene (Kemster, Tuller, Leyden). The reduction of temperature and of pulse-frequency in fever has been repeatedly observed in recent times, after the administration of carbolic acid in various doses.

Carbolic acid cannot be too highly esteemed in all processes in which putrid decompositions are produced by vegetable organisms, acting either as conveyers of septic or infectious substances, or being such themselves. This substance has proved hitherto of the greatest efficacy in Lister's method of operation with the carbolic spray and in Lister's antiseptic dressings. According to Le Blanc, carbolic inhalations produce quite striking effects in putrid decomposition of the bronchial secretions, in the termination of pneumonia in gangrene, and in putrid bronchitis, as described by Traube. Le Blanc also employs carbolic inhalations, usually in combination with iodine, in all catarrhal affections of the bronchi and in the different



stages of ulcerative phthisis, not yet complicated with deposit of miliary tubercles. The percentage composition of the solutions he uses is 1 part carbolic acid and tincture of iodine and 0.5 part potassium iodide. By means of the respirator inhaler Hausmann administers phenol in 5 to 10 per cent. solutions, and Curschmann the alcoholic solutions of 20 and more per cent., as well as the vapours evolved from the pure crystallised carbolic acid in analogous cases of putrid decomposition, in putrid bronchitis, in bronchiectatic and in phthisical lungs.

I consider inhalations of carbolic acid or the analogous salicylic and boracic acids to be absolutely indispensable in the different stages of pulmonary phthisis, in chronic pneumonia, in the liquefaction of caseous infiltrations, also in copiously secreting cavities filled with decomposing products, in deep-spreading laryngeal ulcerations, to the ragged, callous margins of which the decomposing bronchial and cavernous contents adhere, and undergo still further decomposition exposed to the influence of atmospheric air. Again, the widespread mycoses of the air passages and of the lungs which I have repeatedly observed in the course of phthisis are best combated by the phenol spray, and the vegetable parasites which proliferate over the whole respiratory tract even to the pulmonary alveoli are in a short time destroyed by it. Moreover, since the highly infectious character of tuberculosis, already suspected by the older physicians, has been experimentally ascertained, prophylaxis demands that we should attempt by the diffusion of carbolic acid spray to destroy the infectious excretions which are dispersed through the air of the sick room by the coughing and forced expectoration of patients suffering from florid phthisis and tuberculosis, and which, inhaled by others, may give rise to the same diseases in the lungs. (Tappeiner. V. *infra*, Tuberculosis.)

In severe cases of diphtheria I have by means of inhalation irrigated the mucous membranes covered with thick buffy membranes every 5 to 10 minutes for two hours with a 5 per cent. solution of phenol, and in the severe croupy and septic forms have obtained the most successful results. From a large series of observations of the most severe forms which have come under my notice I consider carbolic acid administered in the manner and concentration above suggested to be the best and

most reliable remedy now at our command for the treatment of this formidable and destructive disease, which has hitherto baffled all our efforts.

Lastly, I have used carbolic acid repeatedly with highly satisfactory result in whooping cough (*v. infra*, Whooping Cough), according to Birch-Hirschfeld's and Thorner's process. Occasionally, though very seldom, it was inhaled directly by the patient in a 2 per cent. solution, or else a 5 per cent. solution was pulverised at about the distance of a yard from him in a small space partitioned off by curtains or otherwise, and the patient was exposed to the carbolic spray for an hour at a time 3 to 4 times a day; besides this, he spent the whole day or the greater part of it in the same room in which the carbolic acid was pulverised. As in diphtheria so also in whooping cough I continue the inhalations of carbolic acid in undiminished strength, till it appears in the urine; then I either shorten the period of the inhalations or suspend them for twenty-four hours, resuming them so soon as the urine shows a clear colour again, till the desired<sup>1</sup> effect is produced. I have never so far observed any symptoms of intoxication or other injurious results.

Besides this mode of applying carbolic acid in pulverised aqueous solutions of the percentage given above, it may, by virtue of its ready volatilisation, be employed in the form of vapour for temporary or continuous inhalations, either pure or mixed with aqueous vapours.

For temporary inhalations of mixed carbolic and aqueous vapours a tablespoonful of a 2 to 5 per cent. solution of carbolic acid may be added to a half-litre of boiling water or an infusion of aromatic herbs, and the carbolic acid and aqueous vapours evolved by further heating, mixed with aromatic

<sup>1</sup> I have found the administration of carbolic acid in spray and vapour of the greatest possible value in the treatment of whooping cough and its complications. I am accustomed to cause the patient to inhale a warm spray of a solution of 1 dram of glycerine of carbolic acid to 1 oz. of water in which 10 grains of carbonate of soda are dissolved. This promotes and facilitates the expulsion of the tenacious mucus, which tends to accumulate in the air passages in a remarkable manner. I am also accustomed to order at the same time that the child's room should be charged with vapours of carbolic acid, by dropping the pure acid on a heated iron plate, or a large iron kitchen spoon does excellently.—TR.

vapours, inhaled by means of a funnel or funnel-shaped construction. According to the existing indications these inhalations can be prolonged for 6 to 10 or 15 minutes, and frequently repeated 3 to 4 times a day.

Continuous inhalations by means of the respirator inhaler may be protracted for several hours, the greater part of the day, and even the whole night through, the respirator being worn by the patient even in his sleep.<sup>1</sup> The solutions employed for continuous inhalations, and with which the cotton wool in the receiver is saturated, contain 5 per cent. carbolic acid dissolved in water, and when alcohol is added this proportion is raised to 10 to 20 per cent. and more. Pure crystallised carbolic acid may also be used successfully for continuous inhalation, without any injurious secondary results, where seriously infectious, septic, and putrid processes are concerned.

### 9. Benzol Peroxides.

(a) *Pyrocatechin, benzol orthodioxide*, isomeric with the following, is found in the green leaves of the wild vine, in the eucalyptus, in the different species of cinchona, and is obtained by dry distillation of catechu and catechine, of morin tannic acid, of protocatechu acid, and in small quantities from wood. It crystallises in colourless rhomboidal prisms, which fuse at 102° and boil undecomposed at 245°; it evaporates at ordinary temperature, has a faint but agreeable smell, and is readily soluble in alcohol and water.

(b) *Hydroquinine, benzol paradioxide*, is obtained by dry distillation and oxidation of quinic acid, by the action of fused potash or iodophenol, and of sulphuric acid and hydriodic acid on quinine. Hydroquinine forms colourless prisms, readily soluble in water, alcohol, and ether, which fuse at 172° C. and sublime undecomposed when carefully heated.

(c) *Resorcin, benzol metadioxide*, is formed by fusing many resins with caustic potash, thus from gum resins and extracts of

<sup>1</sup> An exceedingly light and convenient 'inhalation respirator' has been constructed in accordance with the directions given by me in my lectures on the *Antiseptic Treatment of Phthisis*, by Squire, of Oxford St., and sold at the small price of 6d.—Tr.

logwood, from galbanum, much used by the ancients for balsamic fumigations, gum ammoniac, asafoetida, &c. Resorcin crystallises in triangular prisms, which fuse at  $118^{\circ}$  C., boil at  $276.5^{\circ}$  C., but sublime at a lower temperature; it is readily soluble in water, alcohol, and ether, and has a sweetish acid taste. Although the benzol dioxides have not hitherto been largely used in inhalatory therapeutics, it is yet worthy of special attention that they possess properties which may lead to their wide application as inhalents: in the first place, their solutions exercise no corrosive influence upon the mucous membranes with which they come into contact, and may therefore be employed in concentrated forms; and secondly hydroquinine and resorcin, even when absorbed into the system in large quantities, produce no poisonous symptoms. Consequently, in all those cases in which we have reached the limits already fixed for the use of phenol, it will be possible to raise the percentage of these solutions as well as to continue their application uninterruptedly.

The action of benzol dioxides is analogous to that of phenol, parasiticide, and antifermentative and antiputrefactive, but their intensity varies in each, and diminishes in the order in which they are placed. Brieger<sup>1</sup> found that a 1 per cent. solution of all three substances suppressed alcoholic fermentation, also that a 1 per cent. solution of pyrocatechin and hydroquinine arrested the putrefaction of albumen, which a 1 per cent. solution of resorcin failed to do. Again, half per cent. solutions of pyrocatechin and hydroquinine arrested the fermentation of lactic acid, while a half per cent. solution of resorcin had no such power. Andeer<sup>2</sup> gives somewhat higher figures for the antifermentative action of resorcin.

V. Forster,<sup>3</sup> having added a 1 and 2 per cent. solution of hydroquinine to an infusion of pancreas, detected fermentation fungi in it on the fifth day, but with a 3 per cent. solution not till the eighth day. Active development did not occur till the

<sup>1</sup> L. Brieger, 'On the Physiological Behaviour of Pyrocatechin, Hydroquinone, and Resorcin, and their Occurrence in the Animal Organism,' Du Bois-Reymond's *Archiv*, 1879, suppl. vol. p. 61.

<sup>2</sup> J. Andeer, 'On Resorcin,' *Centralbl. f. d. med. Wissensch.*, 1880, No. 27.

<sup>3</sup> Dr. v. Forster, 'Hydroquinone as an Antiseptic in Ophthalmic Practice,' *Aerztl. Intellig.-Bl.*, 1881, No. 22.

tenth and twelfth days respectively. Infusion of pancreas without the addition of hydroquinine showed a considerable proliferation of fungi within ten hours. Even substances already in a putrescent condition, as putrefying pulmonary tissue, when sown with large quantities of fermentation fungi, were prevented from further putrefaction by the addition of hydroquinine solutions, and the rapid movements of the micrococci were almost wholly arrested.

Their action upon cold- and warm-blooded animals, according to Brieger, is in all three qualitatively equivalent to that of phenol, but quantitatively so far different that pyrocatechin has the strongest, resorcin the weakest effect. V. Forster found a somewhat slighter toxical action in hydroquinine than Brieger, but thinks the difference depended on the preparation. Frogs that were immersed in 20 grammes of a 1 to 2 per cent. solution recovered completely after being a long time in cold water, in spite of the production of tonic and clonic convulsions, and ultimately the total loss of power of reaction to any irritation under the influence of the solution during the experiment, which lasted ten hours. Half per cent. solutions continued for two hours produced no toxic effect on the animal.

1 to 3 per cent. solutions of hydroquinine, dropped into the conjunctival sac, produce, in addition to subjective symptoms hardly perceptible to the individual, only a very transient and extremely slight irritation, without detectable alteration of the secretion. The action of hydroquinine in more serious ophthalmic operations, as extractions, is extremely favourable, gives rise to hardly any reaction, and the tendency of the wound to heal is far greater than without the use of antiseptic treatment by means of hydroquinine (V. Forster). Brieger<sup>1</sup> obtained a reduction of the temperature half a degree C. by internal administration of 0.2, better of 0.4 to 0.6, in solution; no other symptoms were set up except moderate transpiration. It was not till the doses reached 0.8 to 1.0 that numerous toxic symptoms appeared—vertigo, tinnitus aurium, accelerated respiration, and flushing of the face. Given subcutaneously, the temperature fell an hour after two injections of a ten per cent.

<sup>1</sup> L. Brieger, 'On the Antifebrile Action of Dihydroxybenzole,' *Centralbl. f. d. med. Wissensch.*, 1880, No. 37.

solution, and the respirations were diminished one-third, while there was a considerable outbreak of perspiration.

The duration of the antifebrile influence was, however, very short; after an hour and a half the temperature had often risen to its former height.

Haab was the first to recommend resorcin warmly for practical application. According to Brieger it possesses the same antifebrile properties as hydroquinine, but doses of 1·5 grammes were needful to produce its effect. The highest reliable dose ought not, however, to exceed 3 grammes. A few minutes after doses of 2 to 3 grammes were given the same symptoms appeared as in the case of hydroquinine, with a violent outbreak of perspiration, followed within one hour by a fall of temperature of 2° to 3° C., combined with simultaneous reduction of pulse-frequency. But these effects lasted but a short time.<sup>1</sup>

Adeer<sup>2</sup> has employed resorcin therapeutically in labour pains, intestinal pains, suppurations and abscesses, vesicular diseases, syphilitic and other affections, in the form of corrosive crystals, of ointment, and of 5 per cent. solutions, and in chronic processes up to 10 per cent. solutions. For local disinfection in cancerous diseases strong solutions up to 50 per cent. are very efficacious. The excretion of resorcin by the kidneys, like that of carbolic acid (v. supra), produces a specific discoloration of the urine, which first assumes a grey, later on a dark brown hue.

The indications for the inhalatory application of benzol dioxide, and specially of the two last, hydroquinine and resorcin, since pyrocatechin at once acts toxically like phenol, and may therefore be left out of the question here, are in general the same as those for phenol. I have unfortunately not been able to experiment with them on a large scale. The results hitherto obtained have been very satisfactory. It would be of great importance if carbolic acid, in all cases in which it has hitherto

<sup>1</sup> Comp. also Lichtheim, 'Resorcin as an Antipyretic,' *Schweizer ärztliches Correspondenzblatt*, 1880, No. 14.

<sup>2</sup> J. Adeer, 'On the Therapeutic Application of Resorcin,' *Centralbl. f. d. med. Wissensch.*, 1881, No. 36, and further communications on the therapeutic use of resorcin, l.c. No. 43.

been found most effectual, could be replaced by the two less intoxicating benzol dioxides. Unfortunately the high price of hydroquinine interferes with its more extensive use.

In all the diseases we have been considering, such as infective parasitic and decomposing processes in the upper and lower part of the air passages and in the air cells, in diphtheritic and septic processes, mycoses, putrid bronchial catarrhs, whooping cough, in bronchiectasia, chronic pneumonia, phthisis and tuberculosis, and in pulmonary gangrene, inhalations of 1 to 5 per cent. solutions of hydroquinine may be employed, according to the indications present, and if they are well borne higher per cent. solutions may be substituted. Resorcin may be administered in much higher doses, and 15 to 20 per cent. solutions may be applied. Pyrocatechin is used in the same doses as carbolic acid; it may be inhaled in the respirator inhaler, as it evaporates at ordinary temperature. It is most desirable that the merits of this substance should receive a thorough practical investigation.

#### 10. *Salicylic Acid (Acidum Salicylicum).*

In 0.1 to 0.2 or 0.3 per cent. solutions.

Salicylic acid, like phenol, retards and arrests fermentation and putrefaction, whether dependent on chemical ferments or on the vegetative process of mould and decomposing fungi; only fluids which contain a large amount of alkaline phosphates and carbonates, such as sweet wort, the juices of flesh, appear to resist the powerful antifermentative action of salicylic acid by forming alkaline salicylates. The influence of this acid in arresting putrefactive and fermentative processes is utterly powerless in presence of its alkaline compounds; consequently in such fluids, unless there is an excess of salicylic acid, no arrest of the decomposing processes will take place. In the blood salicylic acid is converted entirely into sodium salicylate, and as this salt has no influence in arresting the development of the lowest organisms the introduction of salicylic acid into the blood will have no effect on fermentative disease-producing fungi which may be present in it; on the other hand it is capable of arresting or retarding decomposing processes on the surface of the respiratory mucous membrane, in the dilated bronchi and in

cavities, as well as in the air cells themselves, when inhaled with the inspiratory current, and can thus exert an influence upon the pathological processes which depend upon and are maintained by them.

Solutions of 0·1 to 0·2 per cent. inhaled for a quarter of an hour at a time and repeated six, eight, or more times a day, are well borne by the respiratory mucous membrane even in children three to four years of age, and produce no irritating effect. But stronger inhalations, especially when containing alcohol, may act as irritants on the mucous membrane and produce temporary erythematous conditions. The general effects which follow the very large doses which are so well borne when given internally do not appear when it is administered in inhalations.

In slight cases of diphtheria I prefer a 0·1 to 0·2 per cent. solution of salicylic acid inhaled hourly; but in severe croupous and septic cases I have had the affected mucous membrane irrigated every two hours for about five to ten minutes at a time with a 5 per cent. solution of phenol.

I have also employed salicylic inhalations with success in ulcerative laryngitis, putrid bronchitis, and bronchiectasia, and have practised them continuously in pulmonary phthisis for reasons to be given further on.

Indications for the employment of salicylic acid are pretty much the same as for that of carbolic acid, and, as it is inodorous and comparatively tasteless, its inhalations are in most cases preferred by patients; yet it cannot be generally substituted for it, as its action is weaker and its effects often somewhat different.

### 11. *Thymol.*

Thymol has an antiparasitic and a disinfectant influence analogous to that of carbolic and salicylic acid, but it has the advantage of possessing an agreeable odour, a strong deodorising action, and is somewhat less volatile than phenol. It arrests the formation of both fermentative and putrefactive fungi, and counteracts the effects of putrid purulent matter in the animal organism.

According to Buchholz thymol in the proportion of 1 : 2000



water arrests the development of bacteria, and in the proportion of 1 : 200 destroys their power of reproduction. In my own experiments diphtheric fungi were rendered completely incapable of development after having been submitted to the action of a one per cent. solution of thymol in equal parts of water and alcohol, and inoculations into the muscles with diphtheric membranes treated with such solutions for a quarter to half an hour produced no effects. I employed this drug for the first time in diphtheria in solutions of 0·5 to 1 per cent. in equal parts of water and alcohol. These experiments were made between the years 1870-74, and are mentioned in the first edition of Ziemssen's Manual of Special Therapeutics, on 'Epidemic Diphtheria.' Thymol has decidedly a more powerful influence over the local process of this disease than sodium salicylate or benzoate, but it is inferior to carbolic solutions.

Other indications for its employment in infectious and putrid processes are on the whole identical with those mentioned for the other members of this class.

Alcoholic solutions of thymol in various strengths may also be inhaled continuously by means of the respirator inhaler.

## 12. *Eucalyptol (Oleum Eucalypti e Foliis).*

From the leaves of the eucalyptus globulus, a gigantic Australian genus of the order Myrtacea, of exceedingly rapid growth, an ethereal, oxygenated oil, eucalyptol, is obtained; it is a colourless, very volatile liquid, when inhaled in the form of vapour has an agreeably refreshing influence, in dilute solutions smells like the rose, boils at 175° C., is nearly insoluble in water (1 : 3800), readily soluble in alcohol. Oleum eucalypti is to be regarded as the active constituent of the preparations of eucalyptus.

According to the investigations of Binz and Siegen eucalyptol acts almost more powerfully than quinine in arresting putrefaction and fermentation, more especially where the excitement is produced and maintained by the vegetative process of vegetable organisms. Gimbert's experiments also showed it to be a powerful antiseptic; blood and pus were preserved in it for five months, and the development of fermentative and

putrefactive fungi arrested. A number of observers agree in stating that it acts upon animals and human beings like oil of turpentine, from which it is only distinguished by its more delicate odour; when inhaled it exerts an analogous influence on the mucous membrane, as I have myself frequently observed; it diminishes and ameliorates the character of the secretions, especially in putrefactive processes, and facilitates expectoration. Inhaled in larger quantities, it produces headache, intoxication, and mental apathy. Eucalyptol, when absorbed into the blood, is again excreted with the expiratory air and in the urine, which, as after inhalations of oil of turpentine, acquires an odour of violets.

Inhalations of eucalyptol were tried first by Mosler in pulmonary hydatids, where it appeared to promote the detachment of the echinococcus vesicles better than any other remedy, and acted as an expectorant and antiputrescent; he afterwards employed it in diphtheria, in which he observed reduction of the fever and rapid removal of the exudation from the pharyngeal cavity. Mosler made use of a mixture of equal parts of oleum eucalypti e foliis and alcohol, which was added to the water in the little glass vessel of a steam pulverising apparatus in the proportion of twenty drops to each teaspoonful, and inhalations of the atomised solution were administered hourly for twenty minutes at a time. Later on he adopted the following formula:—

Ole. eucalypt, e fol. . . . .	2·0 to 5·0	grm.
Spirit. vin. rect. . . . .	20·0 „ 25·0	„
Aq. dest. . . . .	150·0	„
and for the weaker solution . . . . .	170·0	„

and to ensure an intimate mixture of the oil it must be sufficiently shaken up before it is poured into the flask.

I have not myself made much use of eucalyptol in diphtheria, as for the last two years I have treated all the severe cases which came into my hands with carbolic inhalations, and we cannot form a judgment from slighter cases, however numerous. In cases of bronchitis and phthisis complicated with bronchitis, sometimes with copious putrid secretion, the action of inhalations of eucalyptol seemed to me analogous to that of oil of turpentine.

## 7. NERVE STIMULANTS.

*Mode of Action.*—These remedies act in the first place by exciting the sensory nerves of the respiratory organs, the *nervus trigeminus* in the nasal mucous membrane, but especially the *vagus*, both in its laryngotracheal and bronchial ramifications and its pulmonary terminal branches, and secondly they act reflexly upon the respiratory centres, by stimulation of which respiratory movements are excited and maintained. In the same way they produce a reflex stimulation of the recurrent nerves, and especially of the muscles that close the glottis, though the influence is not permanent. Lastly, disturbances of conduction, such as are produced by certain nervous maladies, by hysterical affections, and by reflex excitation conducted from other nerve tracts, and disturbances in the co-ordination of movements may be influenced by these remedies, in the same manner as by those which are administered internally in these diseases.

The stimulation and excitement which these inhalations produce are not followed by hyperæmia or by any change of tissue, as is the case with alterative and stimulating remedies, and are limited to the peripheral and central nervous apparatus. But if some of the preparations are applied in too large a quantity they may produce hyperæmic conditions.

The following are the *indications* for the employment of the remedies coming under this category :—

1. In *asphyxia*, *dyspnœic* and *apnœic conditions*, in *fainting*, from whatever cause, to stimulate afresh the interrupted or retarded respiration, and promote a temporary increase of cardiac activity.

2. In the *permanent dyspnœa* arising from chronic cardiac and pulmonary affections, by exciting respiratory movements, to afford at least temporary relief.

3. In *paresis* of the *laryngeal muscles*, especially those that close the glottis, and the *aphonia* thus induced.

4. In *hysterical disturbances* of the respiratory nerves in general.

5. Finally, in certain *spasmodic affections* of the voluntary

and involuntary muscles of the respiratory organs, those of the glottis and the bronchi, if they are inaccessible to the action of narcotics.

#### MEDICINAL SUBSTANCES.

### 1. *Caustic Ammonia and Volatile Preparations of Ammonia generally.*

Volatile preparations of ammonia are used as smelling-salts, to excite reflexly the respiratory movements by irritating the nervus trigeminus through the nasal mucous membrane, in syncope, alcoholic intoxication, narcotic poisonings, and in all cases of coma in which there is a diminution and threatened extinction of respiration. Caution must be used in the application of the vapours, as too large doses of ammonia, when it penetrates into the deeper part of the air passages, will produce reflex spasm of the glottis (v. supra, Ammonia).

It is employed after the manner of ordinary smelling-salts, viz. inhaling the vapours directly by the nose from a small bottle.

### 2. *The Ethers.*

Acetic and sulphuric ether, spiritus ætherus, Hoffmann's drops, liquor anodynus Hoffmanni, are employed in the same cases for the purpose of reflexly stimulating respiratory movements—in fainting, asphyxia, in various morbid affections, chiefly hysterical.

### 3. *Acetonum Anglicum,*

an intoxicating and stupefying agent, stronger than alcohol, but weaker than ether and chloroform. It was formerly largely employed in the form of vapour for inhalations, and Hastings in particular recommended it highly as a specific in the treatment of phthisis; he states that it relieves the breathing, diminishes dyspnoea, and alleviates the cough, and that expectoration is frequently increased immediately after inhalation.

### 4. *Camphor.*

Camphor acts as a powerful stimulant upon the brain and the medulla oblongata, without material alteration of cardiac activity, but with considerable decrease of temperature.

Inhalations of camphor were formerly recommended (Böttcher and Raspail) in diseases of the respiratory organs and spasmodic affections, also to relieve hoarseness and aphonia, and in combination with ammonia (Harwood) in the treatment of phthisis (Snow), in which it was said to diminish the cough.

The vapours of camphor were either directly inhaled by means of a glass tube or a quill filled with small pieces of camphor, closed above and below with cotton wool and taken into the mouth, or the camphor snuffed up like snuff, or, finally, a lump of camphor was hung in a little gauze or muslin bag round the neck of the patient. A. Vogel used this treatment, which has the advantage of keeping the patient permanently in an atmosphere charged with camphor, in two cases of spasm of the glottis with success. Waldenburg also reported a similar good result, and considered the drug and the method deserving of a further trial.

#### 5. *Oleum Animale Æthereum*,

having a very disagreeable smell, acts as a powerful excitant; it has been recommended in a 0·2 to 2·0 per cent. aqueous solution with 1 to 10 parts of rectified spirit or 1 to 2 parts of acetone for exciting respiratory movements and stimulating the vocal cords in many forms of hysterical aphonia.

#### 6. *Aqua Asafœtidæ*,

recommended in asthmatic cases, and in hysterical paresis of the vocal cords.

#### 7. *Aqua Castorei*

acts like the preceding drug and analogously to oleum animale æthereum. Ziegler tried it in asthmatic cases.

### 8. REMEDIES ACTING ON THE CONSTITUTION,

sometimes locally, sometimes generally, as when given internally.

#### 1. *Iodide of Potassium (Kalium Jodatum)*.

In 0·2 to 0·4, 1·0, or 2·0 per cent. solutions

#### *Iodine (Jodum Purum)*.

In 0·005 to 0·01, 0·02, or 0·1 per cent. solutions.

*Tincture of Iodine (Tinctura Iodi).*

0·05 to 0·1, 0·2, or 1·0 per cent., with addition of 1 to 5 per cent. rectified spirit in aqueous solution.

The action of iodine on the animal tissues depends on its strong affinity for hydrogen, leading to decomposition in the form of hydriodic acid.

The chief part of the effect of iodide of potassium depends on the iodine it contains, and it is only in the case of comparatively very large doses that the potash produces any appreciable effect on the system. It is quite possible that a liberation of free iodine from its salts may occur in the system; but we have hitherto failed to detect even a temporary liberation of iodine in the blood and in the tissues, and it has been therefore assumed that the iodine which has been liberated by exchange in the blood and in the tissues at once enters into combination with albuminous bodies. Iodine as well as iodide of potassium appears in all the secretions—the saliva, urine, bile, and milk—only a few minutes after its absorption, and generally within 24 hours all the iodine has been eliminated from the system, chiefly in combination with sodium.

Iodine and iodide of potassium are rapidly absorbed from all the mucous membranes into the blood, whereas it appears impossible to obtain absorption of its potassium compound by the skin. When iodine comes into direct contact with the mucous membranes it acts as a powerful irritant, and when inhaled may give rise to inflammation of the laryngeal and bronchial mucous membrane, with violent coughing and burning pain. On the other hand, in the case of ulcerations of these mucous membranes by the combination of iodine with their secretions, as in the case of solutions of nitrate of silver, a firm coagulated covering is formed, under which they may heal more rapidly.

Two of the properties of iodine, its ready volatility and its specific influence over scrofulous maladies, especially in relation to tuberculosis, led to its early employment in diseases of the chest.

While Laennec regarded the emanations of iodine from seaweed (*fucus vesiculosus* v. *verrucosus*) as the most active constituent of sea air, which he held to be the best remedy in phthisis, and ascribed the rare occurrence of pulmonary tuber-

culosis on the coast of Brittany to their influence, Berton in 1828 and Murray in 1830 had already tried direct inhalation of iodine vapours in phthisis, and reported very favourable results in some instances from their use even in desperate cases, and at other times only temporary amelioration of the morbid condition. Later on Scudamore, then especially Piorry and Chartroule, Huette and others in France, employed iodine in various forms for inhalation, and observed more or less favourable results from its use in tuberculosis and other pulmonary diseases. Other observations, however, in opposition to these were soon forthcoming, in which no such results had been obtained from iodine vapours, and in which they even appeared to have exercised a deleterious influence. Thus Little not only obtained no successful results from iodine inhalations, but he occasionally observed acute inflammation of the tracheal mucous membrane and other symptoms of irritation follow its application.

Nowadays the different preparations of iodine are employed almost exclusively in the treatment of syphilitic affections of the air passages, in many forms of pharyngitis and laryngitis, also in thickenings and tumefactions of the pharyngeal and laryngeal mucous membrane, sequelæ of syphilis. So also iodine is still employed in various catarrhal and parenchymatous inflammations of the pharynx and larynx, where a scrofulous or herpetic dyscrasia exists, and is also recommended in simple pharyngitis and pharyngitis grænulosa. In pulmonary and laryngeal phthisis experiments with inhalations of iodine are for the present rather out of favour, and the results hitherto announced do not enable us to come to a decided conclusion as to their efficacy in these diseases, but the probability seems against them. Waldenburg has quite recently made a number of careful experiments, cautiously employing the smallest doses, but without obtaining any satisfactory solution of the question.

Murray's method of developing iodine vapours was remarkably simple; he placed an open vessel containing moistened iodine so that the aqueous vapours evolved from an apparatus standing close by should pass over it. The iodine was thus volatilised and diffused in the form of violet-coloured vapour through the room of the patient.

Piorry heated 20 to 90 grammes of tincture of iodine in a glass vessel, so that vapours of iodine and alcohol were evolved from it, and the patient drew one deep inspiration and repeated these inhalations gradually from time to time. There are various other methods of conveying iodine into the lungs in the form of vapour, but none of them have come into general use.

Thus Leigh ordered inunctions of a strong iodine ointment into the chest and axillæ of his patients, and then had the bed-clothes drawn over their heads, so that they inhaled in this manner the vapourised iodine; he also calculated upon the absorption of iodine through the skin.

Chartroule recommended smoking iodine cigars, in the smoke of which Klecinsky detected hydriodate of ammonia. Löwe found in one cigar 0·05 gramme and in a Paris cigarette 0·038 gramme of iodine.

Iodine was also used in pastils (Trochisci), made of a mixture of fifteen parts charcoal, three parts iodine, with mucilage of tragacanth.

Lastly, Huette, instead of simple iodine vapours, employed the vapours of iodic ether, using for the purpose a phial into which 1 to 2 grammes of iodic ether were introduced with a graduated pipette, and placing over it a thin layer of water, to prevent its too rapid evaporation. The patient held the phial to a nostril and inhaled the ether in deep inspirations. He states that 15 to 20 inhalations were sufficient to impregnate the system with iodine and to enable it to be detected in the urine.

Since the introduction of pulverising apparatus aqueous solutions of the different preparations of iodine are almost exclusively employed, and the remedy is most simply and commodiously introduced into the trachea in the form of spray. The per cent. proportions must be determined by the indications offered by the nature and extent of the malady.

## 2. *Corrosive Sublimate (Hydrargyrum Bichloratum Corrosivum).*

In 0·02 to 0·05, 0·1, or 0·2 per cent. solutions.

The local effect of mercurial preparations soluble in water upon the parts with which they come into contact, especially



upon the mucous membranes, is directly corrosive, as they form solid compounds with the albuminous bodies scarcely at all soluble in water. Mercuric chloride is the most corrosive of all the mercurial compounds. If the mercurial salts are largely diluted with water, like other caustics, they lose their corrosive power. After prolonged exhibition of all the preparations of mercury, and in some cases after a very short time, the well-known acute mercurial symptoms appear in otherwise healthy subjects, while in syphilitic disease the appearance of the specific action due to the mercury absorbed coincides with the appearance of the topical effects peculiar to the drug.

The properties of mercury, volatilising at  $40^{\circ}$ , boiling at  $360^{\circ}$  C., qualify it for impregnating the system by inhalation of mercurial vapours; and mercurial fumigations are among the earliest methods which were adopted for the application of this remedy. When syphilis first appeared in Italy at the end of the fifteenth and beginning of the sixteenth century, mercurial fumigations were employed first by Johanu de Vigo, and Guidi, Fracastori, H. Schmid, and others at once disseminated this new method, by which at that time the most favourable results were obtained in this disease. Stokes also recommended its application in syphilitic laryngitis, and Langlebert prescribed a preparation of cinnabar, charcoal, nitre, mucilage, and some benzoic acid to be used in pastils, while Nevin recommends the smoking of mercurial cigarettes made of red precipitate as a remedy for syphilitic ozæna, the vapours being inhaled into the oral cavity and expired with closed mouth through the nose. In the East to the present day mercurial fumigations and inhalations are extensively employed. According to the reports of Pollak, physician in ordinary to the Shah of Persia, the antisiphilitic treatment most in vogue there is the inhalation of mercurial vapours. For this purpose a cinnabar lozenge is added to the narghile tobacco, and this pipe smoked once to twice a day. In using the fumigations the patients are completely undressed, their eyes are covered, some covering is fastened round the neck, and they are then exposed to the mercurial vapours. These fumigations are repeated twice a day. Pollak has observed highly favourable results from this method even in inveterate cases.

Recently mercurial inhalations have been almost exclusively administered in the form of pulverised solutions, especially in syphilitic affections of the respiratory organs, either alone or in combination with other treatment. Thus Demarquay witnessed the disappearance in a very short time of numerous *plaques muqueuses* of the soft palate, the pharynx, and the larynx after inhalations of a 0.05 per cent. solution of corrosive sublimate, and Schnitzler also employed with success inhalations of 0.2 per cent. solutions in ulceration of the naso-pharyngeal space and the larynx. Lewin recommends inhalations of sublimate in cases in which, after recovery from syphilitic pharyngolaryngitis, submucous and mucous swellings remained behind in the pharynx and larynx, and he communicates a case of syphilitic stenosis of the larynx which he effectually cured by this treatment. Waldenburg also mentions inhalations of corrosive sublimate as the most successful remedy in affections of the pharynx and larynx, and he states that he himself found it efficacious in very obstinate cases in which general treatment had utterly failed. Waldenburg recommended it in many non-syphilitic affections of the pharynx and larynx which present a certain external resemblance to syphilitic processes, in intense parenchymatous inflammations of the mucosa and submucosa with tendency to ulcerations.

Waldenburg further states that he has occasionally found the sublimate very efficacious in affections which, as he expresses himself, are analogous to lichen and lupus, are frequently attendant on cutaneous affections, and may therefore be characterised as herpetic. Lastly, Siegle has cured syphilitic ulcerations in the larynx by inhalations of corrosive sublimate.

In the application of the sublimate, as in that of energetic remedies generally, superficial inspirations are to be prescribed, to avoid the deeper penetration of this active agent into the air passages. It is therefore specially advisable to employ the Mathieu-Windler or the Bergson apparatus for its application.

3. *Arsenic* (*Arsenicum Album*).*Kali Arsenicosum*, *Fowler's Solution*.

In 0.1 to 0.2, 0.4, or 0.6 per cent. solutions.

*Natrum Arsenicosum*, *Liquor Arsenicalis Piersonii*.

In 0.2 to 0.5, 1.5, or 2.0 per cent. solutions.

The development of arsenious acid in the form of vapour by heating sulphide of arsenic (orpiment) was known to the ancients, and arsenical fumigations were employed in ancient times by Galen and in the Middle Ages by Rhazes.

The therapeutic action of arsenical vapours seems to be especially indicated in certain affections of the respiratory organs, asthma and phthisis in particular, and even in quite recent times observations have been published of their success in these diseases. Thus Trousseau recommended the smoking of arsenical cigars<sup>1</sup> in phthisis, and tobacco, mixed with arsenic (0.015 gramme of acid. arsenicos. in a small pipe half filled with tobacco), has been used with satisfactory result in America in spasmodic asthma. Allusion has been made very recently to the fact frequently stated, but not as yet authenticated, that many inhabitants of mountainous regions, especially the Styrians, are in the habit of taking a small piece of arsenic in the mouth when they climb heights, to counteract dyspnoea, and this has been supposed to furnish an analogy to the action of arsenic, especially as stated by the French physicians. Wistinghausen also, in treating a 'neurosis of the larynx,' which manifested itself by pain in the laryngeal region, heated three drops of Fowler's solution with two teaspoonfuls of water over a spirit lamp, and made the patient inhale the vapours. After three weeks of this treatment the neurosis disappeared.

Since the introduction of the pulverising apparatus aqueous solutions of potassium or sodium arsenicate have been exclusively employed, and Wistinghausen, Lewin, Waldenburg, and others

<sup>1</sup> Mode of preparation according to Trousseau: natr. or kal. arsenicos. 1 to 2 grms. are dissolved in 10 grms. of water, and about 2 grms. of this solution is poured on a sheet of paper, which, when saturated with the fluid, is dried and rolled into little cigars. The patient smokes the cigars, also inhaling the vapour into the bronchi 2 to 3 or 5 times.

have obtained quite remarkable results from them in asthma and emphysema. I myself have repeatedly made use of inhalations of the aqueous solution of potassium arsenicate, especially in nervous asthma, but have never been fortunate enough to obtain any such satisfaction.<sup>1</sup>

It is unnecessary to say that in the application of this highly poisonous drug we must always begin with weak solutions and increase their strength very gradually. It is also important to notice the existence of any counter-indications to these arsenical inhalations, and especially to take into consideration the general state of the system.

### 9. MINERAL WATERS.

When we come to classify mineral waters according to their therapeutic action, we must place them among the resolvents; for when they are brought directly into contact with the surfaces of the mucous membranes they exercise, by their alkaline constituents, a solvent action on the mucus, and so promote expectoration, while they also act to some extent as emollients.

Their physiological and therapeutic effects depend on the proportion of carbonate of soda, common salt, or alkaline sulphides which they contain, and coincide in part with the action of these alkalies. We must also take into account the large quantity of water, so that mineral waters exert much the same effect as solutions of the same strength of the alkalies which they contain. Mineral waters have no particular advantage over these solutions, except the simplicity of their application and their undeniably favourable mineral combination, which makes it in many cases desirable to employ them in inhalations where they are indicated.

#### 1. *Alkaline Waters.*

Among alkaline waters those of Ems are the most extensively employed as inhalations, and were the first to be so used (Wistinghausen and Vogler).

Of the 0·33 per cent. solid constituents in these waters about 0·2 per cent. consists of bicarbonate of soda and 0·1 per cent. of common salt, and it is to the presence of these that the influence

<sup>1</sup> It is not in the 'nervous' so much as in the 'catarrhal' forms of asthma that arsenic is of undoubted service.—TR.

of the water upon the surface of the mucous membrane is chiefly due. The presence of the other solid constituents may be ignored, but the amount of water will materially influence their action, alleviating any irritable conditions which may exist, and promoting expectoration. The small amount of saline constituents in the water will act favourably upon the epithelial surface generally, and in catarrhal affections upon the layers of cells in process of desquamation and reproduction, whereas pure water acts upon these structures as a powerful reagent and destroys the young cells by exciting endosmotic action. According to Virchow, dilute alkaline solutions have the power of restoring the movements of the ciliated epithelial cells, when they are lost, and Sprengler has himself observed this effect of Ems water. If we place a portion of ciliated epithelium with the cilia still in motion under the microscope, and wait till the ciliary movement has partially or wholly ceased, we may restore it by moistening the epithelium with Ems water. The free carbonic acid contained in the water can at most be only efficacious in inhalations administered on the spot, as scarcely any traces of it are discoverable in the water in the stone flasks. The carbonic acid itself, set free in pulverisation, acts in some degree as a stimulant and at the same time allays irritation, but aggravates any difficulty of breathing, and so interferes with inhalation in the case of patients who suffer from dyspnoea.

Inhalations of Ems water are indicated in the later stages of acute or subacute catarrh of the pharynx and larynx as well as of the trachea and bronchi, in which concentrated solutions of carbonate of soda produce irritation, and the application of astringents, such as alum or tannin, for arresting the process induces an aggravation of the inflammatory symptoms. So also in hyperæmic conditions of the larynx resulting from overstrain, and attended with a feeling of dryness and tickling, less frequently of pain or burning and pricking in the larynx, with roughness and thickness of the voice, and due to slight swelling of the margins of the vocal cords or secretion of scanty, tenacious mucus, which occurs frequently with public speakers, actors, and singers, I have always obtained satisfactory results from inhalations of Ems water several times in the day. Also

in pharyngitis sicca, and especially in dry catarrhs of the larynx, the trachea, and the bronchi, the Ems water may be used to relieve these symptoms, which it does by moistening the surface and promoting secretion, and by diluting and thinning masses of tenacious mucus they are rendered much easier of expectoration. When the indications are similar, Ems water may also be used with advantage in many forms of phthisis and tuberculosis.

Finally, in order to produce a more decided effect in catarrh of the mucous membranes a concentrated solution of the natural salt of the Ems springs was obtained, containing the constituents of the Ems springs twenty times concentrated, i.e. having 4 per cent. of carbonate of soda and 2 per cent. of common salt, by evaporating the König Wilhelm springs at Ems. In order to obtain the degree of concentration suitable for each case, the best plan is to mix the soluble Ems salt with the water of the Victoria spring, as this is the richest in carbolic acid. This stronger solution of the Ems salt is applicable more particularly in chronic catarrhs, in pharyngitis sicca, to relieve the symptoms in pharyngitis granulosa, also in chronic laryngo-tracheitis and bronchitis, both in the simple form and when complicated with emphysema, partly to stimulate healthy secretion, partly to facilitate the expectoration of abundant and consistent mucous accumulations; it is also useful to some extent in bronchorrhœa and in many torpid forms of tuberculosis. Instead of the Victoria spring, distilled water or pure rain or spring water may be used for the required dilution, as the influence of the solution depends wholly on the amount of carbonate of soda and common salt, in the reciprocal proportion of 2 : 1, which it contains.

Unless, like Waldenburg, we prefer simple solutions of bicarbonate of soda and common salt, we have in the employment of the Ems salt a means of greatly extending the use of the Ems springs in the treatment of respiratory diseases.

Other mineral waters have an analogous action to the Ems water, corresponding to the percentage of alkalies contained in them—Vichy with about 0·5 per cent., Bilin with about 0·3 per cent., Obersalz springs with 0·24 per cent. of bicarbonate of soda, &c. It is unnecessary to enter further into this subject.

## 2. *Common Salt Water.*

The effects of the common salt waters in the various spas have no kind of advantage over ordinary solutions of chloride of sodium of the same strength, and have therefore only a certain value in their own localities, while in other places they can be entirely replaced by the solutions of common salt.

In places where the different springs contain a widely varying proportion of sodium chloride, as at Soden in the Taunus and at Kissingen, where the different springs contain from 0·2 to 1·5 per cent. of common salt, these several springs in themselves supply the possibility of varying the dose accordingly, and are thus suited to the treatment of a large series of diseases. In saline baths, as at Reichenhall, Ischl, Rheme, the brine is diluted in various degrees, and is thus obtained of the necessary concentration adapted to individual cases.

As the action of these mineral waters and the indications for their use are precisely identical with those of sodium chloride, I need only refer to the section which treats of this substance.

## 3. *Sulphur Water.*

Although it was the idea of applying sulphur water directly to the respiratory organs that first led to the invention of the method of pulverising medicinal fluids, and although in France it was regarded as the chief object of the new method, yet its application to diseases of the respiratory organs is very limited, and, like alkaline and common salt waters, they have been very generally superseded by artificial solutions of the alkaline sulphides and sulphuretted hydrogen water, which admit of a more exact estimation of the dose.

The effects of sulphur waters depend in the first place on their solid constituents, which act as solvents, then on the sulphuretted hydrogen they contain, and, although some of this escapes during pulverisation in the form of sulphur compounds, a sufficient quantity remains to act as a calmate, and then there is the water itself, by the action of which they take their place as resolvents and emollients, and may therefore be

applied wherever such remedies are indicated. Sulphur waters are, however, extensively used in France in almost all diseases of the respiratory organs, in angina tonsillaris, pharyngitis, and laryngitis granulosa, chronic laryngitis, aphonia, spasm of the glottis, bronchitis, emphysema, asthma, pulmonary and laryngeal phthisis, syphilis of the pharynx and larynx, and to a certain extent in cardiac affections.

The spas most frequented for the inhalation of sulphur waters are, in France, Pierrefonds, where Sales-Girons first effected the pulverisation of the local water, also at Eaux-bonnes and Euzet-les-Bains. In Germany the thermal sulphur waters at Aix-la-Chapelle, and those of Baden, near Vienna, in Switzerland those of Schinznach, are employed in the same manner, while the silicated water of the cold springs at Weilbach and Nenndorf has been used on a very large scale.

## 10. GASES.

### 1. *Oxygen.*

We have no very important therapeutic results to report from the use of oxygen inhalations, although when the gas was first discovered by Priestley great hopes were entertained in many quarters of its efficacy as a remedial agent, and fresh attempts have been repeatedly made to utilise it in a variety of maladies by changing the form and mode of its application.

The theory of the supposed agency of oxygen gas in promoting change of tissue and altering pathological processes is shaken by the negative results of thoroughly reliable observers, so that we can no longer place the action of oxygen gas above that of pure air, free from injurious admixtures, and all statements to the contrary should be weighed very carefully.

The introduction of oxygen into the blood is, by far the largest part, effected not by absorption but by chemical combination, and Hoppe-Seyler proved that the hæmoglobin of the red corpuscles is the constituent with which the oxygen combines. The amount of oxygen capable of being absorbed through the lungs depends, therefore, almost exclusively on the amount of hæmoglobin contained in the blood, and arterial blood is more



than nine-tenths saturated with oxygen. The variations in the amount of oxygen in different individuals depend solely on the variations in the amount of hæmoglobin itself, as the amount of oxygen and the amount of hæmoglobin are always in proportion to one another (Pflüger). It is true that the blood is also subject to Dalton's law of the absorption of gases by fluids, according to which the weight of the quantity of gas absorbed by a fluid is proportional to the pressure to which the gas is submitted; but this exception only occurs in an appreciable degree under a very high condensation of oxygen and under the pressure of several atmospheres. Under ordinary or slightly increased atmospheric pressure the amount of oxygen absorbed by the serum is too small to be taken into account in the processes of which we are now treating. In Lavoisier's experiments, and in the later and more accurate experiments of Regnault and Reiset, no essential influence upon the quantity of oxygen absorbed and that of carbonic acid discharged in a given time was exercised by the inhalation of an atmosphere of pure oxygen, or by the increase of the pressure of the oxygen in the atmosphere by that of an additional atmosphere.

The results which P. Bert has obtained by experiments on dogs with regard to the influence of compressed air on the amount of gases contained in the blood are here of considerable importance. Besides the quantity consumed by the hæmoglobin for conversion into oxyhæmoglobin, and which was independent of the pressure of gas within the limits taken into account here, a quantity of oxygen which varied with the pressure was at the same time absorbed, amounting, however, to hardly 0.5 vol. per cent. at 1 atmosphere and 37° C., but sufficient to exemplify the proportionate increase to the increased pressure of the atmosphere which the amount of oxygen contained in the blood shows under increase of atmospheric pressure in Bert's experiments.

In the following table the amount of oxygen contained in the blood of the carotids of dogs kept in compressed air is tabulated and reckoned at 0° C. and 760 mm. barometric pressure.

Pressure of atmospheric air under which the dog was placed in atmospheres	Oxygen contained in the blood in vol. per cent.				
	1 Dog	2 Dog	3 Dog	4 Dog	5 Dog
1	19·4	18·3	18·4	22·8	20·2
2	—	19·1	—	—	—
3	20·9	—	20·0	—	—
5	—	20·6	—	23·9	—
5½	—	—	—	—	23·7
6	23·7	—	—	—	—
6¾	—	—	21·0	—	—
8	—	—	—	25·4	—
9¼	—	—	21·2	—	—
10	24·6	21·4	—	—	24·7

Bert also took blood which under the ordinary atmospheric pressure absorbed 14 per cent. by volume of oxygen, and shook it up with oxygen under increased atmospheric pressure, and found under six atmospheres 19·2, under twelve atmospheres 26, and under eighteen atmospheres 31·1 per cent. by vol. of oxygen in it. The blood, therefore, contained, in addition to the fixed and constant amount of oxygen in combination with the hæmoglobin, absorbed oxygen in accordance with Dalton's law.

Bert found that the highest limit reached in animals inhaling an atmosphere containing oxygen of higher density was from 28 to 30 per cent. by volume (0·76 metre pressure) of oxygen in their arterial blood. Pure oxygen, under a pressure of 3·5 atmospheres, was fatal to animals, slight trembling of the head and feet being followed by strong convulsions repeated at pretty regular intervals, but becoming weaker and weaker till death supervened.

Speck's experiments upon the absorption of oxygen agree with P. Bert's, but their value is necessarily diminished by the fact that these were only of a few minutes' duration.

According to Speck, the absorption of oxygen into the blood, besides its combination with hæmoglobin when the gas is inhaled, is also subject to the law of the diffusion of gases, and its absorption into the blood fluctuates within pretty wide limits, according to the rate of pressure of the oxygen in the inspired air. The more oxygen the inspired air contains, the more oxygen will also be absorbed; yet, whatever amount of oxygen

is contained in the air, the blood reaches a condition of saturation beyond which the absorption of oxygen steadily diminishes. Still, according to Speck's experiments, no increased oxidation accompanies this increased absorption of oxygen, nor could he detect any increased excretion of carbonic acid nor any elevation of the temperature as a result of it; so also he failed to observe any change in his own sensations when breathing air richer or poorer in oxygen, especially with regard to greater or less freedom of respiration.

And now the question arises whether the oxygen introduced through the lungs into the blood is in a neutral or in an active state. As oxidation in the animal body occurs at a lower temperature than is possible outside the organism, the hypothesis was started that oxygen must be transported in an active modification as ozone (in the same way as in spongy platinum) by the blood corpuscles as conveyers of ozone to the cellular tissues, and, by its action, the albumen, the fat and carbohydrates were there consumed; and that therefore all these organic compounds might be oxidised at a lower temperature by means of ozone, outside the organism, just as in the living body.

Plausible as this hypothesis appears, the critical and experimental observations of Hoppe-Seyler, and especially of Pflüger, demonstrate its inaccuracy. Pflüger's view is that animal oxidation is analogous to the slow combustion of active phosphorus in dilute oxygen, in which the cause of the chemical combination lies wholly in the phosphorus. He further holds that the combustion of animal cells is, within wide limits, altogether independent of the relative pressure of the neutral oxygen, and has no belief in the presence of an active oxygen. All the facts, he says, tend to prove that the oxygen of the blood is neutral, so that it retains its transportability, and is able to be conveyed in all directions by the blood corpuscles at the natural temperature of the body, as the investigations of Donders have shown. If ozonisation of oxygen were to take place in the blood, this transportability necessary for diffusion would be at once lost. At all events the oxygen could not in that case benefit the tissues. For the further discussion of this subject we must refer to the works of Pflüger and Hoppe-Seyler themselves.

Now that this fact is made known the efforts will have to be abandoned to seek to bring about a therapeutic effect in the sense of accelerating oxidising processes in the body by inhalation of ozonised air or by internal administration of ozone water. The only advantage arising from ozonised air is that it promotes the combustion of deleterious gases and of readily oxidisable bodies, and by its influence upon ferments and low organisms it exerts a cleansing influence on the air, so that in a highly ozonised atmosphere the general sanitary conditions are improved. Ozone as such cannot make its way into the blood itself either in the way of inhalation or by the internal administration of ozone water, since it finds substances enough on the mucous membranes with which to combine and so to lose its active character. On the other hand, it may provoke disease by exciting inflammation, as it is apt to do when it comes in contact with the mucous membranes when in a dry state and unprotected by mucus, owing to its strong chemical activity; thus it may give rise to colds in the head and to laryngeal and bronchial catarrhs (Rossbach, Nothnagel). According to Schönbein's experiments a proportion of 1 : 6000-2000 of ozone in the air suffices to produce in small animals, such as mice and rabbits, violent excitement and disturbance of respiration, terminating in death with symptoms of collapse, while larger animals and men, after the inhalation of considerable quantities of ozone, are seized with symptoms of irritation and inflammation of the respiratory organs. But even were we to imagine that ozone as such could penetrate into the blood, which is physiologically impossible, it would only exercise a disturbing influence upon the constituents of the blood instead of producing any therapeutic effect.

No equivalent therapeutic results whatever can be set over against these physiological facts; indeed, the greater number of the former are of so problematical a character that, in the reforms indispensably necessary in our therapeutics, we must simply ignore the majority of them from Priestley to Lender. Waldenburg has, with his characteristic thoroughness, tabulated and critically examined all the various diseases in which oxygen is said to have been employed with advantage, so that we may refer those interested in the question to his writings on the subject.

The employment of oxygen inhalations seems to be most justified scientifically in cases in which the relative pressure of oxygen is considerably lowered, and in maladies attended with dyspnoea in which the blood is overcharged with carbonic acid. P. Bert was the first to demonstrate by experiments on animals and on the human subject that in an attenuation of the air down to 450 and 400 millimetres of the barometer the symptoms of oxygen insufficiency are set up, but by the inhalation of more richly oxygenised air further reduction of the pressure can be borne.<sup>1</sup> Again, the aeronauts Sivel and Croce-Spinelli, who provided themselves for their aerial journey with a Bert's apparatus, succeeded, by inhaling pure oxygen gas, in alleviating and even partially dispelling the symptoms of giddiness, nausea, faintness, increased frequency of pulsation and respiration, which gradually appeared under the influence of attenuation of the air at 400 to 300 mm. atmospheric pressure. In a subsequent balloon voyage up to 300 mm. of barometrical height = 7,300 metres above sea-level, and an oxygen pressure of 8·29 per cent. of an atmosphere, they found the inhalations of oxygenised air recommended by Bert to be extremely efficacious and invigorating.

Under pathological conditions arrest of the diffusion of oxygen from the lung into the blood may give rise to a similar diminution of the tension of the oxygen of the blood as the lowering of the relative pressure of that gas in the atmospheric air. In such cases an increased supply of oxygen will, in the same way, avert the immediately threatened danger, although it exercises no direct influence upon the cause which gives rise to it. Accordingly, we find indications for the use of oxygen inhalations in those diseases of the respiratory organs which are attended with severe dyspnoea, due to defective exchange of gases and consequent accumulation of carbonic acid in the blood, such as acute exacerbations of chronic catarrh, emphysema, asthma, attended with cyanosis and dyspnoea, in which, according to the published reports (Birch, Ascherson), oxygen inhalations arrested the dyspnoeic attacks often when they had assumed a most dangerous form. They seem also to be theoretically justified in croup, in order to support life till the air

<sup>1</sup> *Compt. Rend.* part lxxviii. p. 911.

passages have again become free, in asphyxia, in chloroform poisoning and poisoning with toxic gases, and for inducing artificial respiration in apnoëic cases, when circumstances enable us to make immediate use of the gas. Hitherto, however, there are no published records which furnish any satisfactory account of the extension of the use of oxygen inhalations.

The favourable effect, in cases of respiratory insufficiency, of a moderate increase in the pressure of oxygen in normal atmospheric air upon the respiration, is often observed in the pneumatic chambers which are now established in various towns and health-resorts for the treatment of a variety of diseases, especially those of the respiratory and circulatory organs, and the utilisation of which for therapeutic purposes will be fully treated of hereafter in the Physical Section. Upon entrance into the chamber of compressed air, a large portion of oxygen and nitrogen is received by absorption into the blood, corresponding to the increase of pressure of the two gases, which in the case of nitrogen continues to be increased through the whole blood, in that of oxygen in the arterial blood only, other conditions being equal, till the patient returns into the ordinary air. Patients suffering from deficient oxygen diffusion due to any disease of the respiratory organs are relieved from much of the difficulty of breathing which they experience in ordinary air, in compressed air, which again conveys the necessary quantity of oxygen to the lungs (*v. infra*, Pneumatic Cabinet).

Far less justifiable is the administration of oxygen inhalations in general diseases, which either arise from defective hæmatisis or are connected with imperfect oxidation, such as chlorosis, anæmia, leukæmia, uric acid diathesis, gout, &c., and although a large number of therapeutic results have been reported, exact proof of the absolute necessity of supplying an increased amount of oxygen for the relief of those pathological processes is as yet wholly wanting. Very numerous statements as to the utility of an increased supply of oxygen in these maladies are to be found in the reports of the influence of compressed air in the pneumatic chamber on nutrition and sanguification; we have not yet, however, received any satisfactory reports of successful treatment by inhalation of pure oxygen gas

uncomplicated by the mechanical effect of compressed air and the consequent, though slight, increased reception of oxygen by absorption. And even where favourable results have been obtained it is still a matter of doubt whether the inhalations of pure oxygen were more efficacious than residence in pure good forest and mountain air would have been, and whether the effect said to have been produced is due to those inhalations or to the general regimen accompanying them, to the other medical treatment pursued at the same time, or finally to nature herself.

The inhalation of compressed air in the pneumatic chamber and the increased absorption of oxygen thereby induced is also recommended for the reduction of obesity and tendency to corpulence, by its influence in promoting oxidation and the gradual combustion of the fats and adipose substances. This recommendation is based partly upon actual experience in the chamber, partly on observations made by workmen in the diving-bell, who are exposed to the pressure of several atmospheres, and whose fat suffers rapid oxidation. But in this case also there is as yet an absence of accurate experimental investigations as to the metabolic influence of compressed air, and the reports which do exist cannot yet claim the merit of an exact exposition of the processes which occur under such circumstances. Neither are Speck's experiments of any value here, as only slight degrees of compression of the air were employed for his inhalations, and they only lasted for a short time, but the processes here under consideration may take another form when the blood remains for several hours at a time subject to the pressure of air condensed by  $1\frac{1}{2}$  to  $1\frac{2}{7}$  atmospheres. Future investigations will lead to a clearer understanding of this question. Inhalations of pure oxygen gas have not been hitherto tried in cases of obesity; but, according to our knowledge of the processes of oxygen and oxidation, we have no *à priori* justification for expecting any particular result from them.

Lastly, some of the sequelæ of certain pathological processes may present indications for the employment of oxygen inhalations. Theoretically it is quite justifiable to test their efficiency in the wasting of the blood and nutrient fluids which occur in slowly progressing convalescence after severe illnesses and

operations, in exhausting ulcers which refuse to heal, in caries, and in gangræna senilis (Waldenburg). In these cases the treatment is based upon the theory that the gas has a tonic influence. But here again we may assume with the greatest probability that inhalations of pure oxygen are not likely to be more efficacious than residence in good, pure air, free from injurious admixtures, in which oxygen is present in excess; but the assimilation of oxygen, as we know, does not depend on the quantity present in the air, but wholly on that of the hæmoglobin in the blood. Here again, as in all the therapeutic accounts hitherto published, the results at present reported from inhalations of oxygen gas are by no means certainly established, and the whole question of the therapeutic value of oxygen requires to be thoroughly and comprehensively investigated anew. Anyone who should do this would be entitled to gratitude.

We need not enter upon the discussion of the therapeutic value of inhalations of ozonised oxygen, nor its many curative triumphs in all possible diseases, since the absorption of ozone through the lungs is physiologically inconceivable.

In administering inhalations of oxygen we may either employ pure oxygen gas, which we can either prepare ourselves for ourselves or procure from a chemist or apothecary, or we may use the condensed oxygen of the compressed air chamber, in which the patient remains for  $1\frac{1}{2}$  to 2 hours; in this case a part of the two gases, oxygen and nitrogen, is absorbed into the blood, according to the increased pressure of both. For inhalation of pure oxygen the gas is conveyed in gasometers, bladders, or indiarubber bags, and respired by means of a well-fitting mouthpiece, or better a mask for the whole face. To estimate the quantity administered once or more daily, we can calculate the contents of one or more of these receivers full of gas either pure or mixed with a little air. The movable apparatus on the principle of the gasometer is convenient for this purpose, out of which oxygen, either pure or mixed in given percentage proportion with atmospheric air, may be inhaled under any increase of pressure desirable, and at the same time the volume of gas used can be accurately read off.



## 2. *Nitrogen.*

We are in possession of two monographs written at the end of the last and beginning of the present century on the action and use of nitrogen, one of which, by Wintrop Saltonstall, does not rise above the region of pure hypothesis, while the second, by Dagoumer, simply develops the ideas which were given currency by the investigations of Nysten, who stated that he observed a sedative influence upon cardiac action after injections of nitrogen into the veins. Later on Mérat and Lens mention in their 'Dictionnaire Thérapeutique' that nitrogen is used very rarely or not at all in medicine. Inhalations of this gas mixed with a certain amount of oxygen were held to be useful in chronic affections of the chest, and two cases of phthisis were observed by Marc, in which an improvement of the general condition was said to be obtained by its influence in retarding the circulation. Nysten considered that nitrogen was indicated generally in those diseases of the respiratory organs which depend on acute congestion.

Further investigations were made by Demarquay and Leconte, from which they concluded—

1. That injections of nitrogen into the cellular tissue and peritoneum are followed by a more or less considerable exhalation of the gases of the blood, i.e. oxygen and carbonic acid, the amount of which varies very much, especially in the case of oxygen, according to whether the animal under experiment is engaged in the process of digestion or not; and

2. That nitrogen exercises no irritating influence over wounds, as oxygen and carbonic acid do, and that therefore, in an atmosphere charged with it, it would be possible to bring about a healing by the first intention with certainty.

The first attempts to employ nitrogen inhalations on a large scale were made at those spas whose springs contain a large proportion of nitrogen gas. The water at Lippspringe contains 4.4 per cent. of nitrogen gas, and in 100 parts of the gas streaming freely from the spring there are 83.25 parts of nitrogen, which is very loosely combined with the water, as it escapes in a few minutes. Similarly, the gas which flows out of the Ottilien-

Quelle at Paderborn (Inselbad) is composed of 97 per cent. nitrogen and 3 per cent. carbonic acid.

Helft asserts that sufferers from chest affections, with very excitable vascular system, who, especially when the bronchial mucous membrane is inflamed and irritated, are seized with fits of coughing when inhaling pure atmospheric air, feel an agreeable sensation while inhaling the thermal gas, and can take deep inspirations without coughing, and that their expectoration is either diminished or facilitated. He recommends these inhalations in cases of pulmonary phthisis with great emaciation, notwithstanding free taking of nourishment, where a retardation of tissue-change is desirable, also in the stage of softening. He states that under their influence the hectic fever abates, and frequently disappears altogether; the cough becomes less severe and the patient regains appetite and sleep. These inhalations are also recommended by Härling and by Rhufuss in pulmonary emphysema, when there is a tendency to inflammatory catarrhs of the larynx and bronchi.

Treutler has recently patented a dry form of administering nitrogen inhalations. Atmospheric air is slowly passed through iron filings moistened with a solution of sulphate of protoxide of iron, and is thus almost completely deoxygenised; the iron becomes oxidised through the medium of the green vitriol, and at the same time exercises a reducing influence upon the latter, as long as any metallic iron is present. The sulphate of protoxide of iron remains almost unaltered; only about  $\frac{1}{6}$  of sulphate of peroxide of iron separates out, and this does not interfere with the action for a long time. Should this, however, occur later on, it is sufficient to fill the apparatus again with iron vitriol.

The nitrogen obtained in this manner may be collected either in a gasometer or in the ordinary pneumatic apparatus and administered in inhalations. Treutler employs for the purpose a double pneumatic apparatus, like that of Weil, with conducting tubes on both sides, furnished with doubly perforated cocks, which admit the entrance of atmospheric air, as well as that of the air passed through the apparatus, and thus allow of the accumulation of nitrogen in the inhalation cylinders in the mixture desired. Thus an uninterrupted and uniform inhala-

tion is provided, since while the contents of the one cylinder are in use the other fills according to regulation. A single turn of the cock, which the patient, duly instructed, can himself attend to during inhalation, is attended with the following results:—

1. The preparation of the nitrogen, as the air is drawn through the apparatus by the turning of the cock;
2. The conveyance of the nitrogen, and
3. The prescribed mixture of the nitrogen with atmospheric air within the inhalation cylinder, and thus the complete adaptation of the mixture and exact measuring of the dose for every individual case.

The closing of the cock at once arrests all activity in the apparatus for preparing the nitrogen, so that it is only during inhalation that any consumption of the chemicals takes place; consequently one apparatus can suffice for about 10,000 administrations before the whole of the iron contained in it is oxidised.

Treutler, like the earlier authors, believes the nitrogen to act indirectly by diluting the oxygen and so lessening its irritating influence on the more or less sensitive mucous membrane, as well as by diminishing oxidation, which would be attended with reduction or retardation of tissue change, with lowering of temperature (of fever) and increase of fat formation. According to Legallois the inhalation of highly nitrogenised air diminishes the excretion of carbonic acid and the absorption of oxygen, some nitrogen being absorbed in the process; Dr. Speck also has made some experiments with Treutler's apparatus, and, after communication by correspondence, came to the same conclusion with regard to oxygen and carbonic acid; finally, Fränkel found by experiments on dogs, and Litten by breathing in a greatly elevated temperature, that a considerable diminution of the supply of oxygen was followed by an accelerated disintegration of albumen and with increased formation of fat and urea. The objection that the patients breathe more or less deoxygenised air for only one to two hours a day, while they spend the rest of their time in ordinary atmospheric air, loses weight, he thinks, as opposed to the above theory, when an influence in proportion to the dose is in question, in the

same way that other remedies, baths, &c., are applied, especially if the results of the investigations of Legallois, Speck, and Fränkel should be confirmed.

The results empirically observed in patients are, according to Treutler, pallor and cooling of the skin during inhalation, the pulse becoming small and more frequent. With a very great increase of nitrogen some vertigo may occur; this soon disappears, and is followed occasionally by headache, never by fainting or asphyxia. Even in the most severe cases a feeling of exhilaration and easier breathing are generally the immediate result of inhalation; sometimes lassitude and oppression in the lower part of the chest occur in consequence of the unaccustomed respiration, but are of short duration; the tendency to cough is diminished during and after inhalation, or it may be necessary to increase somewhat the quantity of nitrogen for its relief.

After inhalations of nitrogen from eight to fourteen days Treutler also observed that the sleep became calm, the appetite increased, the night sweats diminished, and if any diarrhœa existed it was allayed; there was also increase of pulmonary capacity, of body weight, and, except in desperate cases, of bodily strength and activity. Meanwhile the fever was variously influenced: in slighter cases it soon disappeared; in others it was sometimes even aggravated for the first week or two, afterwards diminishing somewhat rapidly or ceasing altogether, while in hopeless cases it was unaffected.

Treutler is of opinion that improvement in the local physical condition does not in general keep pace with the subjective amelioration; it was often four to five weeks before any reduction of the area of dulness of the infiltrated portions of the lungs was observable, and that the abnormal râles diminished, and when these disappeared catarrhal conditions often persisted obstinately for another two to three weeks, when they often disappeared rapidly and unexpectedly.

Nitrogen inhalations are therefore indicated in—

1. Chronic catarrhs, especially apical catarrh attended with fever, slight cough and anæmic symptoms, giving warning of commencing phthisis; Kohlschütter found nitrogen inhalations less efficacious in catarrhal processes;

2. Chronic pneumonias, pneumonic infiltrations with or without preceding hæmorrhages (Köhlshütter);

3. Chronic phthisis requires too long a continuation of the treatment to enable us yet to form a judgment;

4. Acute phthisis, in which the object is to procure as great an alleviation as possible or the removal of distressing symptoms, such as restlessness at night, night sweats, diarrhœa, &c.;

5. Bronchial and spasmodic asthma.

There are no actual counter-indications for these inhalations because of the indifferent behaviour of nitrogen towards the physiological functions and tissues, especially as its failure as a remedial agent can be ascertained in a comparatively short time, so that there need be no delay in adopting another course of treatment. Only once Treutler considered that he had observed a directly injurious result in a case of Bright's disease with uræmia, and he therefore held that the presence of this disease counterindicates the use of nitrogen inhalations.

### 3. *Hydrogen.*

Hydrogen is a perfectly indifferent gas towards respiration, and its only use is, as is also the case with nitrogen, to dilute the atmospheric oxygen and so proportionately weaken its effect.

This gas has not yet been used therapeutically, although isolated experiments have been made with it in the direction we are considering. In cases in which this modification of the respiratory air is indicated it will be better to substitute nitrogen.

### 4. *Carbonic Acid.*

The toxic properties of carbonic acid, at one time unsuspected, are now universally admitted, and it is known that even 1 per cent. of carbonic acid in the respired air produces poisonous effects, even though it may, at the same time, contain an excess of oxygen.

In former times carbonic acid was largely employed in inhalation experiments, and many favourable results were

supposed to be obtained by its use; but now this view is entirely laid aside, and the use of the gas is exclusively limited to health-resorts and spas where carbonic acid forms a main constituent of the mixture of gases which is evolved from the local springs, as at Ems, Meinberg, and Franzensbad. In these places, however, the inhalations of the gases from the springs are used for the most heterogeneous conditions, even in dyspnoea and asthma (Vichy), and under circumstances which safely justify the conclusion that the supposed effect is purely illusory. At Ems Sprengler in particular made use of the inhalation of the thermal gases in the treatment of pharyngitis granulosa; Küster also praises the effect of the gases at Kronthal in various morbid conditions. But as the gases at Ems contain a proportion of fifteen to twenty per cent. of carbonic acid they form a wholly irrespirable mixture, and Vogler and Panthel even assert that they cause irritation and inflammation of the pharyngeal mucous membrane, so that they are not even available in the treatment of pharyngitis.

Helfft<sup>1</sup> enters into a thorough investigation of the action of inhalations of carbonic acid. He considers that they are specially beneficial in cases of deficiency of air resulting from mucous concretions in the pulmonary alveoli, in that the gas corrects the torpor of the mucous membrane and at the same time improves the character of the secretion, thus removing the offensive smell of the sputa of many such patients (?) Observations, he says, have taught that two to four per cent. of carbonic acid gas, mixed with atmospheric air, exercises a decidedly invigorating influence upon healthy individuals and invalids; the healthy subject would naturally after a little time in such a pneumatic chamber experience a certain acceleration of the respiration, which becomes altered, so that the expiration is prolonged and stronger and the inspiration shorter. With the necessity of more complete expiration would be combined an acceleration of the pulse and a feeling of warmth in the chest, which would be followed by a decrease of mucous secretion in the air passages and a sensation of dryness in the throat. Then increase of perspiration would gradually follow, and finally giddiness and flushing of the face. These symptoms, in Helfft's

<sup>1</sup> Helfft, *Balneotherapie*, 7th ed., Berlin, 1870, published by Krieger, p. 287.

opinion, are evidences of the stimulating influence of the gas on the respiratory organs. But, as we are not writing critical observations on balneotherapy, we must refer those interested in the question to the literature directly bearing upon it.

### 5. *Sulphuretted Hydrogen.*

The use of sulphuretted hydrogen for inhalations introduces us directly into the subject of balneotherapy.

Apart from the development of sulphuretted hydrogen in the pulverisation of sulphur water which is inhaled together with the fluid spray, sulphuretted hydrogen, as well as carbonic acid and to some extent also nitrogen, is evolved from the springs at different spas, and employed as inhalations in various diseases of the respiratory organs. The therapeutic influence of this gas also is very far from being securely established, and its application is chiefly founded upon the statements of balneological reports upon the curative power of their thermal gases.

As far as the physiological effects of sulphuretted hydrogen upon the mucous membrane, the blood, and the nerve-centres are known to us at present, no certain indications can be established for its application, and the reports from different quarters of the results produced by small doses, such as elevation of temperature, oppression on the chest, augmented secretion of the sudoriparous and mucous glands, promotion of the exchange of nitrogen with reference to the excretion of urea, its favourable action towards parasitic and septic maladies, still await confirmation. In consequence of this absence of a safe scientific basis the therapeutic value of sulphuretted hydrogen inhalations must still be regarded as an open question.

The first extant balneological communication upon the efficacy of inhalations of sulphuretted hydrogen is that of Gebhard, who claims to have observed as the immediate effect of the gas baths at Eilsen moderate increase of heat, causing gentle transpiration, diminution of frequency of pulse, quieting of the dry irritative cough, and a feeling of relief and exhilaration. This mixture of gases was thus indicated in diseases of the respiratory organs, especially in pulmonary phthisis, where there was a constantly tormenting cough attended with little or

no expectoration, difficulty of breathing, and a sensation of pressure and burning in the chest, with flying, stabbing pains in different directions. Yet he warns against the use of all gas baths, but especially those of the local pulmonary baths, in violent congestions and inflammations, especially when they have a sthenic form, and recommends in these cases, according to circumstances, general or local venesection.

Oleire has published a report upon the results of the gas inhalations at Nenndorf, and fixes the following indications for their use: chronic catarrhs, bronchorrhœæ, phthisis pituitosa and tuberculosa in the first stage, and as counter-indications colliquative hectic fever and inflammatory affections of the thorax. The gaseous mixture, according to his view, acts like digitalis in reducing frequency of pulse, calming the excitability of the digestive organs, diminishing and improving the secretion of the mucous membrane and of the trachea especially.

During a prolonged stay in the gas chamber (Helfft) patients are said generally to feel an exhilarating sensation, the respiration becomes freer, the hawking and coughing are at first somewhat increased, though less distressing, because expectoration is facilitated; the appearance of the sputa is improved, and patients very soon bear the inhalations for several hours; the frequency of the pulse decreases by eight to fifteen beats.

Lastly, according to Grandidier, inhalations of sulphuretted hydrogen are indicated (1) in catarrhs of the larynx, the trachea, and the bronchi; (2) in several forms of phthisis, especially phthisis pituitosa, but florid phthisis is to be excluded; (3) in emphysema and asthma; (4) in whooping cough; (5) in catarrhs of the nasal, oral, and pharyngeal cavities.

Inhalation chambers for breathing sulphuretted hydrogen are to be found at Eilsen, Nenndorf, Aix-la-Chapelle, Weilbach, Langenbrücken, Baden near Vienna, Landeck; also in France, at the spas of Eaux-Bonnes, Cauterêts, Euzet, Amélieles-Bains, Vervet, Pierrefonds, Bagnères de Luchon, Labassère, and other places.

Balneological literature has not yet supplied a satisfactory scientific basis for the therapeutic employment of sulphuretted hydrogen: it is left for future investigators to determine its true value and to define precisely the cases to which it is applicable.



## THE TREATMENT OF SPECIAL MALADIES BY INHALATION.

### A. HÆMORRHAGE FROM THE RESPIRATORY ORGANS.

Wherever hæmorrhage occurs, the immediate adoption of local treatment, whenever possible, for the arrest of the bleeding is indicated. In this case by the closure of the bleeding vessel, either mechanically or chemically, we obtain a direct result, whereas in every other method of treatment we have not the security thus given, and it is always doubtful whether the hæmorrhage has subsided of itself or been arrested by the remedies employed.

Hæmorrhages in the respiratory organs as well as in the upper part of the digestive tube are completely accessible to the application of styptic remedies, as the seat of the hæmorrhage, when in the upper parts, can either be reached by instruments themselves or, as in plugging of the nose, can be healed by directly mechanical means; on the other hand, in the case of deeper-seated hæmorrhages the pulverised solution of some styptic remedy can be conveyed to the spot by the inspiratory current, where it acts by its coagulating effect on the blood and formation of thrombi on the one hand, and by causing constriction of the vascular walls on the other. The first remarkable results of the new method introduced by Sales-Girons which chiefly attracted the attention of the medical profession were obtained in pulmonary hæmorrhages, and the literature at the beginning of the sixth decade of this century is marked by a series of reports on the favourable result of inhalations of astringent and styptic medicines in hæmoptysis, associated generally with pulmonary phthisis in various stages. Promising as this first success was, the extensive application of inhalations of styptics in hæmorrhages of the respiratory organs was soon given up, and other modes of subduing the hæmorrhage were preferred, e.g. applying an ice-bag to the chest, the administration of digitalis, opium, *secale cornutum*, or injections of sclerotic acid. This may be partly explained by the irritability of the respiratory mucous membranes, which does not,

however, manifest itself so frequently as people are apt to assume; but, when it does appear, it not unfrequently leads to constant coughing during the inhalations, which makes it more or less difficult or even impossible to convey copious inhalations of an active solution into the lungs, especially when it is at a very low temperature. Waldenburg maintains that all excitement, such as is inseparable from the application of an unusual method of treatment, should be avoided in hæmoptysis, and that bodily and mental rest are more imperative in this malady than in any other; he therefore only uses styptic inhalations in cases where they are absolutely necessary, and is content as a rule with the ordinary mode of treatment. At the same time Waldenburg's results in treating hæmoptysis by inhalation, more particularly in cases where persistent hæmorrhages resisted all other methods, are entirely in harmony with those of the earlier observers.

Various pathological processes may lead to rupture of the vessels and hæmorrhage from all parts of the surface of the respiratory surface, as well as from that of the mouth, pharynx, and gullet, and their danger and the urgency for arresting them will depend on the quantity of blood effused, as well as on the importance of the organs affected and the possible results which may follow.

### 1. *Hæmorrhage from the Nares (Epistaxis).*

Hæmorrhages from the nose, from the posterior nares, the naso-pharyngeal space, the tonsils, will seldom require inhalatory treatment, as the cavity of the nose presents the most unfavourable conditions for the penetration and diffusion of the fluid dust, and the hæmorrhages themselves are rapidly arrested by other means, viz. syringing and plugging.

### 2. *Hæmorrhage from the Mouth and Pharynx.*

The mouth and pharynx are also so accessible to thorough exploration and operative treatment that hæmorrhages within them are much better dealt with by the manual application of styptics than by inhalations of pulverised fluids. Apart from the frequent hæmorrhages of the gums, hæmorrhages in the oral and pharyngeal cavity are on the whole rare, and are

generally produced by solutions of continuity of the mucous membrane and erosion of the larger vessels or of vascular parts from ulceration or traumatic and operative injury. Inflammatory hyperæmia of itself in a person in all other respects sound rarely gives rise to hæmorrhages which are at all difficult to arrest by simple means. On the other hand, persistent hæmorrhages sometimes occur from congestive and passive hyperæmia, in connection with syphilitic, mercurial, scorbutic, carcinomatous, and more rarely tuberculous inflammation and ulceration, also in purpura and the hæmorrhagic diathesis, and even where the latter does not exist considerable secondary hæmorrhages which demand immediate and careful arrest may follow slight operations, such as extraction of teeth, extirpation of tonsils, excision of uvula or of benignant tumours, and partial removal of carcinomata. Again, hæmorrhages occasionally occur from varicose veins of the pharynx, in which the amount of blood, generally small, often a mere trace, is hawked, not coughed up, mixed with mucus and saliva. Lewin first called attention to this occurrence, and described this pathological change in the pharyngeal mucous membrane as pharyngitis varicosa. In such cases we not unfrequently observe in the pharynx itself a number of varicose veins diffused over the mucous membrane, or a small suggilation on a more or less distended vessel, or protruding beyond the other vessels a small varix, obviously the seat of blood stasis or coagulation. Sometimes, by means of the speculum, we discover that the source of this bleeding is deep-seated, but frequently we altogether fail to discover the origin of the hæmorrhage itself, and the diagnosis thus remains doubtful.

The treatment of hæmorrhages, which must be local or general according to their amount and the causes which lead to them, will be determined by the rules of surgery and special therapeutics, to which we must here refer. The following indications suggest the adoption of inhalatory treatment:—

1. When the hæmorrhage is not profuse, but rather slow and persistent, when no large vessels are eroded, but the blood flows out of small venous radicles and capillaries, and thus bears the character of a parenchymatous hæmorrhage;

2. When the place is not readily accessible directly to

manual applications, as in the pharyngo-laryngeal cavity, in the lower and back part of the pharynx, or when from other causes such treatment cannot be carried out ;

3. When the hæmorrhage recurs frequently, is persistent and long-continued, and when it becomes necessary for the patient to be able to apply a remedy himself.

In violent hæmorrhages chloride of iron is the best agent for rapidly arresting it, employed in 2 to 5 per cent. solution, as it speedily induces coagulation and plugging. The inhalations must either be continuous or only interrupted by pauses of a few minutes, till the hæmorrhage ceases ; and for the next hour, and even the next few days, the inhalations must to some extent be continued, partly to consolidate the thrombus, partly to keep up an astringent action upon the irritated and hyperæmic mucous membrane. In slight hæmorrhages alum may be used ; some think its after-effect is more marked ; also when a copious hæmorrhage has already been arrested by chloride of iron, and it is not considered desirable to continue that remedy, alum may be employed for the subsequent inhalations. Tannin is also used for the same purpose as alum and of the same strength ; in slight cases a speedy arrest may occasionally be obtained by even cold water or ice water.

As in these hæmorrhages it is only necessary that the pulverised fluid should reach the upper part of the respiratory tract, it is better that the deeper and more sensitive organs should be protected from their action, so that no unnecessary irritation in them be induced ; the patient therefore must be made to take shallow, superficial inspirations, which are here fully sufficient for the aspiration of the fluid.

Mathieu and Bergson's apparatus are the best for the purpose, in which the fluid can be inhaled at a very low temperature and the mode of pulverisation is least favourable to the penetration of the fluid into the deeper parts. If a steam spray-producer is preferred, it must be placed somewhat more distant from the patient, that the temperature may be lower.

### 3. *Hæmorrhage from the Larynx and the Trachea.*

We must be careful not to mistake hæmorrhages from the deeper bronchi and the lungs for hæmorrhages from the larynx and the trachea, which is a somewhat uncommon occurrence.

Hæmorrhages from the larynx and trachea are due to solutions of continuity of the vessels from wounds and contusions of the larynx, to erosion from phthisical, syphilitic, and carcinomatous ulcers; less frequently to the rupture of the vessels from congestive or passive hyperæmia, which may occur in such inflammations, in great venous engorgements, and in whooping cough. In many cases it will be possible by means of the laryngoscope to see the source of the bleeding in the larynx, or we may suspect the seat of the hæmorrhage, when vocal or other functional disturbances accompany it ('A Case of Stenosis of the Glottis,' B. Fränkel). The amount of blood mixed with more or less mucus expelled by coughing and hawking is almost always inconsiderable, but in the case of large tumours or ulcerated carcinomata it may sometimes reach a dangerous extent.

Türk observed in a case of laryngeal syphilis with ulceration and necrosis of the right greater cornu hyoides a fatal hæmorrhage from erosion of the arteria lingualis.

The indications for the use of inhalations in the treatment of laryngeal and tracheal hæmorrhages, as well as the styptic remedies and the apparatus that should be employed, are the same as in hæmorrhages from the oral and pharyngeal cavities of which we have already spoken. With regard to the manner of inhaling, the patients should take rather longer and deeper inspirations, in order to convey the pulverised fluid in sufficient quantity into the larynx and the trachea. All other circumstances remain the same.

### 4. *Hæmorrhage from the Bronchi and Lungs.*

The first results calculated to attract the attention of physicians to the new method were obtained in the treatment of pulmonary hæmorrhages by the inhalation of pulverised solu-

tions of styptic and astringent remedies. Hæmorrhage from the deeper bronchi and from the lungs will always remain a favourable object for this treatment, even though exception may be taken to it in some cases for special reasons, and the result, as indeed is the case with every kind of treatment, is not always successful. In all hæmorrhages, from whatever cause, styptic inhalations may be administered either at the outset or at a later period when other remedies have failed. The following are the chief causes of hæmorrhages from the vessels of the smaller bronchi and lungs:—

1. Congestive and passive hyperæmia, especially in cardiac affections, in stenosis of the left ostium venosum, also in aneurisms of the large vessels within the thorax; under this category come also the vicarious hæmorrhages, menstrual and hæmorrhoidal bleedings, &c.

2. Erosion of the vessels, especially of aneurismal or atheromatous arteries.

3. Chronic pneumonia with caseation, in phtthis and pulmonary tuberculosis, in their initial stage as well as in their later course.

4. Carcinomata.

5. Hæmorrhagic infarcts in the pulmonary tissue.

The indication for the inhalation of styptics is in all these cases given by the hæmorrhage itself, and it is optional with the physician to make use of these or some other medical treatment to arrest it.

The kind of treatment will always be determined by the intensity of the hæmorrhage, not only as regards the quantity of the effused blood but also the duration of the bleeding, which may recur with longer or shorter intervals, often daily, while the amount of blood poured out is relatively small. It should be a firmly held principle that in these cases the strongest and most active remedies must be employed, and only laid aside when from special circumstances, such as abnormal vulnerability of the bronchial mucous membranes, they are not well borne. There is a case reported by Lewin of a lady suffering from profuse bronchorrhœa, in whom even very small doses of chloride of iron, 1 drop to 60 grammes of water, produced a slight hæmoptysis each time.

In such cases, unless we prefer to adopt some other method of arresting the hæmorrhage, we must select the medical agent nearest to that which has proved too strong and use that instead.

If the hæmorrhage is less copious and dangerous, especially when it proceeds from small vessels, in so-called passive hæmorrhages, a rapid success may in most cases be obtained by inhalations of 2 to 5 per cent. solutions of alum or tannin. Both these solutions have the further advantage of acting as astringents and limiting secretion in simultaneous inflammatory hyperæmia and swelling of the mucous membrane, thus secondarily promoting the hæmostatic effect.

In urgent cases, however, we must immediately have recourse to concentrated solutions of chloride of iron, without first trying diluted solutions of this salt or tannin and alum, as with these we should probably weary the patient fruitlessly, whereas with the former a speedy arrest can generally be obtained. An apparatus is also preferable which pulverises the solution at a low temperature, on the principle of Sales-Girons or Mathieu and Bergson; ice may also be added to the solution to increase the refrigerating action and obtain a high degree of cold. Most patients bear the inhalations perfectly, even when administered at a low temperature, a fact opposed to the somewhat theoretical objection on the score of the irritation produced by styptics on the mucous membranes; and although at first, as Waldenburg correctly stated, patients are timid at commencing the inhalation and hardly venture to breathe, as the inhalations proceed they begin gradually to inspire more freely, and at length to draw the solution as deep as possible into the lungs. The number of cases which I have observed during the last eighteen years has already become considerable, and, relying upon these observations, I feel bound to maintain not only the hæmostatic effect of inhalations of chloride of iron in pulmonary hæmorrhages, but also that they exercise very little irritation on the bronchial mucous membrane. Only quite recently I have had a case of frequently recurring pulmonary hæmorrhage, and each time it was arrested by a few inhalations of chloride of iron. When, fourteen days later, inhalations of a 0·3 per cent. solution of salicylic acid were

ordered, after the second administration a fresh attack of hæmorrhage came on, which was immediately arrested by chloride of iron; a similar attempt three weeks later had the same effect, but also the same therapeutic result.

In case no pulverising apparatus constructed on the principle above mentioned should be at the disposal of the physician, but only the steam apparatus, care must be taken to obtain the lowest temperature possible by keeping the apparatus as far as can be managed from the mouth of the patient, or by using a long cylinder. If the fluid pulverised by steam is inhaled too close, the high temperature which the pulverised fluid acquires in the process may have the effect of keeping up the hæmorrhage. With due regard to these necessary precautions these apparatus may be employed with great advantage in pulmonary hæmorrhages by reason of the excessively fine spray they produce and the free motility of the fluid particles, and I have observed a considerable number of very striking results from their use.

As soon as the pulverised fluid penetrates into the respiratory tract it produces, in proportion to its concentration, a more or less rapid and abundant coagulation of the blood within it, and which is in part adherent to the bronchial walls, and the patient now begins to expel, at the same time a great deal of coagulated masses of blood, instead of the fluid blood which he previously expectorated. The farther the fluid makes its way down, so as to begin to act upon the bleeding parts, the less is the amount of freshly effused blood, till at last it ceases altogether and only coagulated masses and coagulum mixed with mucus and pus are coughed up by patients. If the hæmorrhage is really arrested, no fresh traces of blood show themselves, and the residue of the previously effused blood continues to be expectorated for a long time, always more and more changed in colour and consistency. The number of the inhalations must not be reduced, nor the pauses between them lengthened, till the fluid blood has entirely disappeared; when the physician is convinced that the hæmorrhage is completely staunched, he may limit the sittings to three or four in the day, and during the following days reduce them to one or two, and so close the treatment.



Should a relapse set in during this time, the inhalations must be resumed with renewed energy and continued for a long time undiminished in number and duration. As already mentioned, it will be always advantageous, even after the total disappearance of all trace of blood in the sputa, to apply concentrated solutions of alum or tannin for some weeks two or three times a day for fifteen minutes at a time.

Finally, as regards the other methods employed in pulmonary hæmorrhages, the local application of styptics must in all cases be accompanied by the application of bladders of ice, the internal administration of digitalis, digitalis with opium, secale cornutum, and the rest of the treatment will be in accordance with the rules of special therapeutics.

## B. DISEASES OF THE NARES.

### 1. *Acute Catarrh.*

Acute catarrhal inflammation of the nasal mucous membrane, like most acute inflammations of the mucous membranes, calls for the application of emollient agents, especially in the form of vapours, or spray, if indeed any medical treatment should be found necessary in this malady, which tends to spontaneous recovery in a short time. The action is symptomatic.

We may employ in the complaint either the vapours evolved from hot water or these combined with the volatile constituents of flores sambuci, flores chamomillæ, flores tiliæ, occasionally also vapours of coffee, tea, or milk, &c. For this object the patient may be either made to inhale through the nose the vapours directly from the vessel from which they rise, or the orifice of the vessel may be wrapped up, and the patient's head at the same time, with a cloth, so that the former may be conveyed more freely and at a higher temperature to the nose. Advantage will also be gained by using a funnel or a simple steam apparatus, from which an indiarubber pipe conveys the fumes directly into the affected nose.

By means of the pulverising apparatus emulsions of gum, weak infusions of rad. althææ, 0·2 to 0·5 per cent. solutions of common salt, or carbonate of soda, or Ems water may be applied

with good effect, especially when the secretion is profuse. The inhalations may be applied for a quarter of an hour 4 to 6 times a day, according to the degree of the affection and the sensitiveness of the patient, if there are no counter-indications.

Vapours of acetic acid and of ammonia have also been used to cut short a catarrh, or else a once very popular mixture of ammonia, carbolic acid, and rectified spirit applied in this way; a layer of 4 to 6 small leaves of clean blotting-paper strongly saturated with the mixture is held before the nose of the patient, who inhales deeply the vapours which are given off at ordinary temperatures. This treatment must also be repeated several times in the day, if any effect is to be produced. The results which I myself have obtained from this last method do not corroborate the favourable statements made in other quarters.

## 2. *Chronic Catarrh.*

The chronic form of catarrhal rhinitis also promises good results from treatment by inhalations, so far as symptomatic results can be obtained by it, considering the nature of the malady and the changes in the nasal mucous membrane which attend it. The principal part of the work must be done in another way, and only the removal of hypertrophies of the mucous membrane and polypous growths by the galvano-cautery and the galvano-caustic loop will ensure permanent cure. Nevertheless I have obtained fairly good results in mild cases of chronic coryza, where there was defective secretion or a secretion of viscid masses of mucus, making the already narrowed canals utterly impervious to air. By the use of a spray of concentrated solutions of carbonate of soda or sal ammoniac, or by applying sal ammoniac in a state of vapour, prepared by the dry method or in a nascent state, the passage of air through the nose was frequently restored and the distressing feeling of dryness removed. But no actual cure was ever effected.

Siegle employed for the development of vapours of sal ammoniac a medium-sized glass retort fitted to a suitable stand. A wide caoutchouc tube terminating in a compressible caoutchouc bag which lies on the ground is drawn over the end of

the retort tube. After a few tablespoonfuls of powdered sal ammoniac have been introduced into the interior of the retort through the tubulure an indiarubber tube which accurately fits the tubulure is passed through it till about an inch dips into the interior of the retort; the other end of the tube is provided with an appropriate covering for the nose. If the retort, which rests upon a wire network, be now heated by a spirit lamp, vapours of sal ammoniac are soon developed in the interior of the retort, and these, by stamping on the india-rubber bag, are driven out with some force through the india-rubber pipe of the tubulure. If this becomes stopped up, by taking it out of the tubulure, and blowing through it, it can readily be cleared.

I myself formerly used in preference for the development of sal-ammoniac vapours the apparatus devised by Lewin, consisting of two glass globes. To the glass tube for the admission of air terminating in the globe containing caustic ammonia I attached a caoutchouc tube, which the patient took into his mouth, and the other caoutchouc tube, which was connected with the glass tube delivering the sal ammoniac, he introduced tightly into a nostril, and so blowing through the tube in this manner he drove the sal-ammoniac vapours himself into his nose. More or less abundant secretion is rapidly set up, and with frequent sneezing masses of liquefied mucus are expelled from the nose, and considerable relief is thus obtained. After the action of vapours of sal ammoniac Siegle recommends the application of diluted astringent solutions—alum, nitrate of silver, sulphate of zinc, acetate of lead, which the patient sniffs in diluted—or else he applies more concentrated solutions to the Schneiderian membrane by means of a brush or by injections.

Small ulcers and abscesses, which occur in acute, but still more so in chronic nasal catarrh, are healed in a short time by inhalations of tepid water.

In other affections of the nose, ozæna, diphtheritic, syphilitic, tuberculous, and carcinomatous inflammations, no special indications exist for the application of inhalations, for in these cases we have other therapeutic means and methods which act energetically on the malady itself and its several symptoms. (For diphtheritic affection v. *infra*, Diphtheria of the Pharynx).

## C. DISEASES OF THE MOUTH AND PHARYNX.

In diseases of the mouth and pharynx the ready accessibility of these cavities enables us, by means of gargles, brushing, &c., to apply medicinal agents easily and effectually directly to the parts affected, and we have little need of inhalations in these cases. We can understand, then, why inhalations are usually reserved for the treatment of deeper-seated parts which we cannot thus reach directly. But even in diseases of the mouth and pharynx the manner in which the medicinal agents are applied is by no means unimportant, and when used in the form of spray their action is so essentially modified by the absolutely non-irritating nature of the application, by the equality of the distribution, by the temperature, and especially by the duration of time during which it continuously irrigates the affected parts, that this mode of application cannot be replaced by any other. Thus pulverised fluids in affections of the mouth and pharynx act like a fine douche, and experience has repeatedly proved that even in affections of the other organs, especially the conjunctiva,<sup>1</sup> such a gentle irrigation of the catarrhally affected tissues is in many cases to be preferred to ordinary bathing or instilling. The same remark applies to diseases of the mouth and pharynx, and another fact worthy of consideration is that in regular shallow inspirations the deeper parts of the pharynx, inaccessible to ordinary gargling, are brought into contact with the medicinal agent. The results obtained by the irrigation of the affected surfaces of the mucous membrane are very considerable, and there are many cases in which this method cannot be replaced by any other.

1. *Acute Catarrhal and Erythematous Angina, Acute Pharyngeal Catarrh.*

Where acute catarrhal angina or pharyngitis comes under treatment, and there is still a possibility of combating the inflammation directly, decided advantage is to be gained by inhaling cold air as frequently and for as long a time as possible,

<sup>1</sup> A *mémoire* of Demarquay and Leiblinger in the *Vienna Allg. med. Zeitschr.*, 1863, No. 8.

or by irrigating the inflamed mucous membrane with the spray of iced water by means of Bergson's hydroconion, 6 to 8 applications a day of 8 to 10 minutes each and longer; this is preferable to garglings with iced water and even to the patient's allowing small pieces of ice to dissolve in his mouth.

In a later stage, when cold is not so well borne, emollient vapours or fluids, spray of tepid water, must be applied, and combined after a short time with inhalations of Ems water or 0·2 to 0·5 per cent. solution of common salt.

If the malady has already assumed a subacute form, and threatens to pass into the chronic form, we would recommend inhalations of alum in 1 to 2 per cent. or tannin in 0·5 to 2 per cent. solution, or nitrate of silver in solutions of 0·1 to 0·2 per cent., or, if an antiphlogistic influence is desired, up to 0·3 and 0·5 for several days in four to six sittings of quarter of an hour each; when the inflammatory symptoms have wholly disappeared, garglings or inhalations of a 0·5 to 1 per cent. solution of common salt must still be continued for some time.

Where a certain sensitiveness remains behind even in later stages and the astringents exercise an irritant influence, a narcotic can be combined with them—opium is the best—in appropriate dose. In this way we may almost always succeed in preventing the transition of an acute or subacute catarrh into the infinitely more obstinate chronic form and its extension to the larynx and the air tubes.

## 2. *Chronic Pharyngeal Catarrh.*

Chronic pharyngeal catarrh in its various forms is one of those maladies which are least susceptible of a complete cure, and the treatment of which is apt to become wearisome to the physician. It is only influenced by internal remedies so far as they are able to act on the constitution of the patient, as when anæmia, chlorosis, scrofula, tuberculosis, previous syphilis or mercurialisation, or abdominal plethora predominate, and then they can exercise a favourable influence on the sanguification, nutrition, and general condition of the patient. Therefore such remedies are of the greatest importance in the treatment of this malady when constitutional anomalies co-exist, and, whereas under these circumstances local treatment alone entirely fails, a

tonic treatment often cures the catarrh without it. The majority of chronic pharyngeal catarrhs, and especially the obstinate forms, depend on some such disturbances of the general health.

In this inconstant and fluctuating malady local treatment must be determined by the anatomical relations of the mucous membrane, the nature of its functional disturbances, the secretion of its glands, and especially by the individuality of the patient himself and the unpleasant and painful sensations produced by the malady.

If the inflammation is attended by hyperæmia, with intense redness and swelling of the mucous membrane, with no tendency to diminished secretion, and without the patient's feeling a constant necessity for expectorating viscid, glutinous masses of mucus, alum, tannin, or nitrate of silver will exercise a favourable influence upon the mucous membrane and be well tolerated. These remedies should also be applied when by their means the secretion is increased and its expectoration facilitated; on the other hand, in catarrhs with scanty secretion of thick, viscid mucus, which gives rise to dry hawking and difficulty of expectoration, solvents such as common salt, sal ammoniac, and carbonate of soda should be selected. In many cases it is highly desirable to begin with the solvents in order to stimulate secretion and to facilitate expectoration, and later on, as soon as this desired result has been obtained, to proceed gradually to the milder astringents. This transition may be conveniently effected by the combination of a solvent with an astringent, sal ammoniac or common salt with alum, sometimes the one, sometimes the other predominating. This combination is in many cases advisable at the very beginning of the treatment, when we wish to limit the secretion but at the same time to promote expectoration.

In a great number of cases, on the other hand, the mucous membrane is pale and anæmic, a scanty secretion gives it a dry appearance (*pharyngitis sicca*), and where the mucus is somewhat more freely secreted it is ropy, viscid, of a glutinous consistency, adheres to the walls, and causes dry hawking and laboured expectoration. At the same time the follicles are somewhat swollen, and protrude as pale reddish bodies, the size of hemp seed or lentils, rarely as large as peas; they are

sensitive, and even their destruction, whether by incision with the knife or by the galvano-cautery, has generally only a slight influence upon the symptoms and course of the malady. Patients complain of subjective sensations of heat and dryness, of irresistible hawking, difficult deglutition, of a scraping, burning, oppressive sensation, and feel themselves considerably relieved by partaking of unstimulating food and mucilaginous fluids. These forms are as a rule associated with constitutional maladies, and in general can only be cured or effectually alleviated by changes in the constitutional state. The most efficient method is local treatment with solvent agents, inhalations of Ems water, solutions of common salt and sal ammoniac, or with weak solutions of nitrate of silver applied several times a day, whereas alum or tannin are in the early stages ill borne and only increase the sensation of heat, dryness, and tickling. Only where the sensitiveness of the throat is very great will emollients be found necessary, and inhalations of oleaginous emulsions, mucilaginous decoctions, or glycerine with 2 to 3 parts of water, or glycerine and sal ammoniac diluted with water be useful instead of alkaline substances from the first or from time to time when the irritability returns. Tincture of iodine with solution of iodide of potassium is also indicated, to stimulate the glands, the mucous glands of the mouth as well as the acinous glands in the pharynx, and to promote an increased activity of absorption in the lymphatic vessels in those parts (Lewin). The effect of this remedy is promoted, especially in the obstinate form of pharyngitis sicca, by painting with a small camel's-hair brush tincture of iodine over the dry spots on the posterior pharyngeal wall, and some time afterwards causing the patient to use solvent inhalations. For this purpose solutions of sal ammoniac, common salt, and especially carbonate of potassium are adapted. Ems water may also be used with advantage. The transition to astringent agents must be gradual, and here alum combined with sal ammoniac or common salt is universally acknowledged to be the most suitable agent. The stronger astringent solutions must be very gradually introduced, attention being always paid to the fluctuations of the symptoms, so that, if irritative conditions should recur, the solvents may again be applied. In anæmic compli-

cations Lewin considers chloride of iron to be the best astringent, and recommends its combination with aq. amygdal. amar., because the odour of the chlorine which is evolved in the inhalation is apt to set the patient coughing.

The most obstinate cases of pharyngitis and those most subject to continual relapses are often the cases with a marked anæmic character, in which there is an extensive development of varicose vessels, pharyngitis varicosa, and patients complain of constant burning, tickling, and dryness in the throat. Here local treatment must necessarily be directed to the relief of the symptoms, and the choice of emollient, solvent, and astringent agents must be determined by the symptoms which are more or less predominant. In most of these cases inhalations of Ems water or solutions of common salt are most easily borne and afford the greatest relief. With regard also to the temperature to be chosen for the pulverised fluid, we must in this form as well as in chronic pharyngitis make up our mind more or less whether we wish to exercise an astringent (cold) or an emollient, comparatively solvent (warm) influence, and modify the therapeutic agency accordingly.

The length of time required for the treatment of chronic pharyngeal catarrh is very varied and depends on its form and complications. Recent simple forms are the most favourable. These are either completely cured or at least so far improved that they do not cause any inconvenience, whereas those complicated with some constitutional malady, as well as all those which have a marked anæmic character, offer the greatest resistance to all treatment, and it is generally only when we can succeed in conquering the general pathological condition lying at their root that recovery or a permanent improvement can be secured.

### 3. *Granular, Follicular Pharyngeal Catarrh.*

This form of pharyngeal catarrh, in which the lenticular conglobate ductless glands are more particularly affected by the inflammatory process, and are more or less swollen, and appear on the mucous membrane as small globular projections, or spread over it in large clusters, or appear as small conglomerated nodules, or else occur as actual neoplasms in the form of



numerous small granular bodies, has hitherto offered the most obstinate resistance to a comprehensive general and local treatment. Since painting with nitrate of silver, tannin, or iodine very rarely produced favourable results, it became necessary to have recourse to more energetic action. Lewin suggested making slight, superficial incisions into the mucous membrane, which is constantly kept in a state of inflammatory irritation by the swollen glands, or even into the underlying glandular follicle, in order to clear it of its contents, as it cannot itself evacuate them, being ductless. It does no harm even to cut a little into the mucous membrane in the vicinity. He considers that a slight bleeding has a beneficial effect on the co-existing hyperæmia, and indeed that it may even contribute to diminish the tendency to recurrence which generally exists. Nowadays we prefer eliminating the numerous small nodules with the galvano-cautery in several sittings, and the most favourable results have been obtained by this method in comparison with former ones, as my own observations, as well as those of Bruns, Michel, and many others sufficiently prove.

The symptoms of this affection point to the value of the inhalations of medicinal solutions which soothe irritation, promote secretion, and dissolve the dry and somewhat encrusted mucus. Weak solutions of common salt, sal ammoniac, and carbonate of soda, pulverised by means of Bergson's apparatus, are generally remarkably well borne; by irrigation of the diffusely affected mucous membrane they alleviate the heat and dryness, they liquefy the thick, tenacious mucus which not unfrequently is everywhere adherent to the walls of the pharynx, and they diminish the feeling of oppression, the sensation of a foreign body in the throat, and the distressing and painful tendency to frequent ineffectual efforts at swallowing. These remedies do not, however, effect a cure, and although there are some cases on record which are supposed to have been cured by inhalations, no case has come under my observation in a tolerably wide experience in which anything more than relief to symptoms was obtained by this method. Alkaline and sulphurous waters act in a similar sense and are well borne; astringents, on the other hand, such as alum and tannin, generally aggravate the already distressing symptoms, chiefly in consequence of their desiccating

action. Weak solutions of nitrate of silver may also alleviate irritation and exercise a somewhat antiphlogistic influence, without, however, on the whole achieving more than the above-mentioned alkaline salts.

#### 4. *Pharyngitis Hyperplastica.*

This form of chronic inflammation of the pharyngeal mucous membrane with hyperplasia of the mucous and submucous tissue is only benefited by inhalations to the same extent as the previous form; viz. it is possible by irrigating the mucous membrane with emollient and solvent remedies to relieve for a time, or even to subdue, the more distressing symptoms. Of course a cure cannot be brought about by this method; indeed, it is but rarely that a retrocession of the pathological changes and abatement of the consequent symptoms can be brought about even by other and more vigorous methods.

#### 5. *Phlegmonous Angina and Pharyngitis.*

When we fail to arrest by means of cold application, by sucking small pieces of ice, by garglings and inhalations of iced water, and the rest of the antiphlogistic processes, the phlegmonous inflammation in the tonsils, in the peritonsillary tissue, and in the rest of the mucous membrane, our object should be to relieve the symptoms developed during the course of the disease, and to accelerate suppuration and opening of the abscess.

This is best effected by energetic application of heat in the form of steam, either alone or combined with pulverised medicinal solutions. We may employ either simply the steam of hot water or vapours of hot milk and decoctions of marsh mallow, which, by virtue of the delicate aromatic substances contained in them, produce a more agreeable sensation than simple steam of water; or herbs rich in ethereal oils may be employed, such as flor. malvæ, flor. salviæ, flor. sambuci, flor. chamomillæ, and others, without any particular difference in the effect.

A favourable influence is exercised upon the subjective condition of the patient as well as upon the course of the inflammatory process by inhalations of alkaline solutions, especially of 1 to 3 per cent. solutions of carbonate of soda or of common

salt and sal ammoniac, by which the initial tension and dryness of the mucous membrane are relieved, and the sticky masses of mucus which later on fill up the oral and pharyngeal cavity of the patient are more readily removed, and under the influence of heat a relaxation of the mucous membrane and rapid suppuration are brought about. Even after spontaneous or artificial opening of the abscess solvent or antiseptic inhalations (1 to 2 per cent. solution of carbolic acid or 0·1 to 0·2 per cent. solutions of salicylic acid) must be continued for several days till the swelling of the tonsils and of the rest of the inflamed tissue is completely gone.

Lastly, the prevalent tendency to recurrence which characterises these affections must be combated with astringent gargles, alum, tannin, as well as the other hardening methods, frictions and cold baths.

#### 6. *Diphtheria of the Mouth and Pharynx.*

Of all the diseases of the oral and pharyngeal cavities diphtheria is that which is most under the influence of medicated inhalations. There is therefore no treatment better able to fulfil the several indications which are most prominent in this complaint, especially as its effects may be followed almost from hour to hour.

In diphtheria, as I have demonstrated, we have to do with an infective disease caused by a fungus which I have named 'micrococcus diphtheriæ,' which, localised in the oral and pharyngeal cavity, produces inflammation and fibrinous exudation upon the mucous membranes, and within a certain time, which cannot be precisely fixed, develops into a general infective malady, in which the general infection is originated and maintained by the local affection. This view is of the utmost importance in regard to treatment, in contradistinction to the earlier one, supported especially by Buhl. With regard to the development and separation of diphtheritic membranes, as well as the pathology of epidemic diphtheria generally, and for an exhaustive criticism of the different methods of treatment I must refer to my treatise in Ziemssen's 'Manual of Special Pathology and Therapeutics,' vol. ii.

The treatment of the local affection must be in accordance with two indications—first, the destruction of the excitant of the disease, and secondly, the removal from the affected parts of the products engendered by the disease. We can now, I think, fulfil both indications better in this disease than in any other infective malady.

1. In combating the cause of the disease itself, we possess in carbolic acid an agent which, though it cannot be credited with the value and importance of a specific, yet enables us to grapple with the process in a manner hitherto impossible. But it is an indispensable condition for the development of its antiseptic and antiparasitic action that it should be applied in far more concentrated solutions than have hitherto been employed.

For three years I have been engaged in studying closely the application of this remedy in diphtheria, and the results of these investigations compel me to this conclusion. I have obtained perfectly satisfactory results in fifty-one of the most severe cases, more than two-thirds of which, I must say, would have proved fatal formerly under any other treatment. And medical friends of mine, whom I induced to employ the same treatment, have reported similar results.

As almost all possible and impossible means and methods of cure were brought to bear upon the treatment of this disease, from the most expectant to the most active therapeutic procedure, including the galvano-cautery, the application of carbolic acid was certain to be repeatedly employed, and I have myself used and recommended it for disinfecting gargles and inhalations.

The unsatisfactory results obtained are exclusively attributable to the insufficient strength in which the remedy was always applied, from the fear more especially of inducing unpleasant general toxic symptoms by large doses.

To show the fallacy of this fear, I need only mention that, in the gravest forms of septic diphtheria, it was not till the blood was impregnated with carbolic acid to such a degree that the urine became of an olive green that I was able to observe a rapid decline of the disease. I therefore employ in all cases for local application to the diphtheritically affected mucous membranes 5 per cent. solutions, as there is no certainty of

success with weaker ones. The cause of this is that the finely pulverised carbolic acid becomes diluted and altered first by mixture with steam and the fluids of the mouth and the morbid products in the oral and pharyngeal cavity, and secondly, after it has reached the mucous membrane and is absorbed, by the fluid of the tissues and the inflammatory serous infiltration and by the blood and lymph generally; so that under these circumstances neither the development nor the multiplication of the diphtheritic fungi will be sufficiently hindered. Just as weak solutions of carbolic acid fail to act with sufficient disinfecting and antiseptic energy on ulcers whose surface is coated with decomposing pus, or putrescent ichorous discharges, even when brought into far longer contact with the ulcerated surfaces by the dressings, so they are equally or even more powerless to disinfect strongly infected surfaces of mucous membrane in the oral and pharyngeal cavity and to arrest the injurious processes of decomposition at work there by occasional irrigations with such solutions.

I apply carbolic acid by making the patient inhale the spray from a steam spray-producer. This is the only way by which a thorough and complete irrigation, both of the diseased and the sound parts, can be kept up with a sufficient quantity of fluid for several minutes together, and that all mechanical injury can be avoided. I take care to avoid all unnecessary irritation of the parts by touching them with brush or sponge. Even in chronic and comparatively torpid forms of phthisical ulceration of the larynx in adult patients Moritz Schmidt fears injurious results from such a mode of applying medicinal agents. Much more risk must there be of such mechanical injury in the case of children, who often oppose the strongest resistance to such manual interference, thus causing the application to be rough and insecure as compared with other modes of application, while the violent acute inflammation reacts most sensitively to all such injury. Moreover, the amount of fluid brought into play is far greater than that which can be conveyed by repeated painting; and, again, the fluid which accumulates in the mouth and pharynx during inhalation, and is swallowed by patients, is in the act of swallowing brought into still closer contact with the porous exudations. Considering how deeply

involved is the lymphatic system of the oral and pharyngeal cavity, in the vessels and glands of which I first discovered diphtheric fungi, I regard the absorption of large quantities of carbolic acid through the lymph spaces and lymphatic vessels of this region as of the utmost importance, in order to neutralise the injurious character of the absorbed products of decomposition in these parts and thus to ward off a further infection of the organism. Besides, it must not be forgotten that it is not alone the false membranes which are the carriers of the infection, but also the surface of the entire oral and pharyngeal mucous membrane and its secretions, mucus, saliva, and the fluids of the mouth generally, and that by their means the disease may not only be communicated to others, but the organism itself may be infected generally.

Lastly, in face of the observations lying before me, I can no longer question the influence which we may obtain over the general infection by large quantities of carbolic acid absorbed into the blood, and the antipyretic and antiseptic disinfecting action resulting from it, difficult as it is to prove such influences while the remedy is locally applied at the same time. In the gravest cases which I have treated with inhalations of carbolic acid the excretion of dark olive-green urine was always attended with a rapid decline of the malady, as regards the fever as well as the local symptoms. In a case of diphtheritic scarlet fever running an exceedingly bad course, in which the whole oral and pharyngeal cavity, both the posterior nares, and the upper part of the larynx were covered with thick, dirty grey membranes, and the pulse was irregular and intermittent, so that I hourly expected the end, I persisted in the inhalations of carbolic acid in spite of the constantly increasing discoloration of the urine, but at longer intervals and for a shorter period. The pulse improved remarkably under the influence of the carbolic acid, became continuous, regular, and stronger, while the membranes were rapidly detached and the affection of the mucous membrane was healed more speedily than could have been supposed. I know perfectly how little reliance can be placed upon such isolated cases, but here the course under the agency of carbolic acid was too marked and coincided too exactly with other observations not to justify their being placed in juxta-

position. I must reserve a fuller consideration of this question for another place.

I administer inhalations, at intervals of one to two hours or more frequently, for five, eight, or ten minutes at a time, according to the severity of the case and the age of the patient, of a 5 per cent. solution of carbolic acid, the patient taking the cylindrical conducting glass tube directly into the mouth. The inhalations are continued for the same time and with the same intervals, unless an aggravation of the malady indicates an increase, till, with coincident rapid decline of the fever, the membranes have for the most part become detached and the swelling of the mucous membrane has gone down. As improvement goes on the inhalations are gradually reduced to every three or four hours, and even longer intervals, while the duration of each of the sittings is simultaneously diminished till complete recovery results. At the same time due attention is directed to the excretion of carbolic acid in the urine and to the digestion of the patient, and if a marked change of colour in the urine is observed and gastric disturbances are set up the number of inhalations are reduced, or if the urinary secretion should suddenly assume a dark olive green colour they may be altogether remitted for the next twenty-four hours, and the carbolic acid may be replaced by other medicinal agents, the best being a 3 to 4 per cent. solution of boracic acid or a five per cent. solution of benzoate of soda. After this respite, when the urine has recovered its natural or a brighter colour, showing that the whole or the greater part of the carbolic acid has been excreted from the blood, the treatment may be resumed according to the above rules. In severe cases I have disregarded a slight greyish discoloration and continued the carbolic acid inhalations till the urine appeared of a dark green colour; then they were exchanged for others generally for the next twenty-four hours only, but resumed as soon as the colouring became lighter, somewhat greyish, and persisted in till the fever sank and the membranes were loosened, which usually occurred before long. I have in no case observed any mischievous secondary results when these precautions were observed.<sup>1</sup>

<sup>1</sup> With regard to the coloration of the urine after impregnation of traumatic surfaces by carbolic acid, v. s., p. 214.

In order to obtain as far as possible practically useful observations, I have chosen only such cases for these inhalations as resembled each other in the gravity of the malady, the height of the fever, and the diffusion of the membranes, and in which I was convinced from former experiences that under any other system of treatment they would not only have run an extremely severe course, but in most cases have terminated fatally. In this way I hoped to avoid the fate which so frequently attends over-hasty conclusions founded on insufficient observations, viz. that the next case one has to treat may upset the whole result.

2. For accelerating the separation of the membranes there are two methods calculated to promote the onset of the natural processes of separation, and so increase their activity—

*a.* The solution of the membranes by suppuration, and

*b.* The mechanical detachment of them by exciting a more active secretion of the mucous glands.

As regards the first method, that of promoting the separation of the diphtheritic exudation by suppuration, the chief agent is the application of heat, which promotes rapid suppuration, demarcation, and detachment of the membranes. I therefore, as before, apply hot steam to the diseased mucous membranes, and that several times a day for varying periods. By energetic application of carbolic acid the demarcation and separation of the membranes are brought about far more rapidly than was formerly the case without it. The reason of this I take to be that the action of carbolic acid removes or limits the local infection by destroying the carriers of infection, the fungi and their spores, and thus again diminishes the fibrinous exudation and promotes a rapid separation by means of suppuration. I therefore did not find much necessity for the employment of heat in the treatment in addition to the inhalations of 5 per cent. solutions of carbolic acid. In slighter cases, however, the influence of heat alone may produce the desired result, and it is then most advisable to combine with the application of heat the irrigation of the affected parts with a spray of 0.2 per cent. solution of salicylic acid or a 2 per cent. solution of common salt or chlorate of potash, in which the water and the alkali serve to liquefy and remove the mucus, and so cleanse the mucous membrane.



As I have shown in Ziemssen's 'Manual of Special Therapeutics,' the first appearances which are produced by the action of hot vapours are always constant, and clearly observable within 12 to 18 hours; only where considerable fibrinous exudation has been thrown out, and partial destruction of the membranes has taken place, and the reactionary power in the tissue is diminished, they will develop more slowly; while they may fail altogether if the disease has already led to septicæmia or to extension of the exudation into the trachea and bronchi, the margins of the diphtheritic patches, which generally separate as a delicate, ring-like border, becoming more distinct and appearing as sharply-marked lines on the intensely reddened mucous membrane. In the same way on places where previously there were no such layers, or only scarcely perceptible whitish patches, the size of a hemp seed, we find distinct circumscribed layers of different sizes, so that the disease itself appears to have increased in intensity. The explanation of this phenomenon is that these places, even though they previously showed only a simple reddening of the mucous membrane, were yet gravely affected; and under the influence of the hot steam increased secretion of pus corpuscles is induced, which infiltrate the infected epithelium, crowded with micrococci, or the delicate fibrinous network, where it had already advanced to the stage of fibrinous exudation.

But under the continuous influence of hot steam and free irrigation with carbolic acid the exudation ceases to spread. The false membranes become gradually thicker, and detach themselves from the mucous membrane; their whitish-grey colour changes to a yellow, dirty grey; their surface becomes wrinkled and uneven, while even the redness of the adjacent mucous membrane diminishes and the swelling recedes. After a few days the false membranes become completely detached, with a corresponding amount of suppuration.

According to the manifestation of these reactionary appearances I begin on the 4th or 5th day, seldom later, to diminish the number of applications of steam, and when the separation of the membranes is in full progress and a large part is already detached, I limit them to four in the day; in the same way I steadily reduce the application of carbolic acid, and distribute

it over six to eight sittings of eight to five minutes each. When the membranes are all detached, I still continue carbolic inhalations three or four times a day for the two following days; by this precaution I have always hitherto warded off a recurrence of the malady, renewed infection of the mucous membrane, and repeated formation of diphtheritic exudation.

As regards other local remedies which may be employed in diphtheria, thymol, eucalyptol in solution in water and rectified spirit, boracic acid, salicylic acid, creosote, benzoate of soda, permanganate of potash (the discolouring property of which interferes with the inspection of the affected parts and is otherwise inconvenient) are all, according to my observations, decidedly inferior to carbolic acid, while chlorate of potash is utterly insignificant and in no way superior to common salt; lime water and lactic acid may certainly under some circumstances dissolve or liquefy the fibrinous coagulum, but they possess no antiseptic or disinfecting influence, and as in these cavities it is not a question of local narrowing and danger of stenosis, as in the larynx or the trachea, there is at least no indication for their employment.

As to the insufflation of these remedies by air-pressure pulverisation, as in Bergson's or other similar apparatus, or by injection or painting with a brush (the best is a large one with fine hair, which will imbibe a fair quantity of fluid and can be squeezed out against the affected parts without injuring them), they are far less effectual than inhalation by means of the steam spray-producer, which ensures the simultaneous action of heat, which favours purulent demarcation and detachment of exudation, and should be reserved for those quite exceptional cases in which the patient cannot be reached in any other way.

Only weaker solutions are adapted for gargling, such as are in daily use.

A second but less trustworthy method is that recommended by Guttman, the object of which is, by the specific action of the *folia jaborandi* and especially of the *pilocarpinum muriaticum*, to excite an augmented secretion of the mucous glands underlying the pseudo-membranous exudation, and so bring about their mechanical detachment, and at the same time effect a free discharge of the fungus vegetations and of the septic substances from the oral and pharyngeal cavity by

means of these agents and of the increased salivary secretion, which coincides with the augmented secretion of mucus.

As these medical agents are applied either by subcutaneous injection or internal administration, the discussion of this question really lies outside the prescribed limits of our subject; but as it seems to be closely connected with the antiseptic treatment of diphtheria, as above described, and as I consider it important enough to engage the attention of physicians, I will here devote some special remarks to it.

When we cut through a mucous membrane which is covered with a thick diphtheritic exudation in process of separation, we see how the mucus pouring out of the dilated ducts of the glands percolates upwards in different directions, part working its way through the fibrinous coagula lying directly over the ducts and spreading into the network, and part insinuating itself between the margins of the false membrane and the sub-epithelial or basal membrane, tearing aside the fibrinous threads by which the two are held together, and causing a detachment of the membrane to a great extent.

Besides these observations on the natural process of detachment of diphtheritic membranes, I was induced, by observing a case in which rapid separation of the false membranes followed upon salivation accidentally complicating the diphtheric attack, to try this second method of natural solution of the fibrinous deposit by administration of *folia jaborandi* and *pilocarpinum muriaticum*. On account of the disagreeable secondary effects of the *folia jaborandi* I have for the present restricted myself to the use of *pilocarpinum muriaticum*, and either administered it at short intervals in aqueous solutions of 0.02 to 0.05, according to the age of the patient, or, especially in the case of adults, more particularly when the pathological process has already lasted several days, given it in subcutaneous injections. The two modes of administration differ in their mode of action in this respect, that after administration of *pilocarpinum muriaticum* the stimulation of the secretion of the salivary and mucous glands follows more slowly and less violently, whereas salivation occurs almost immediately after its subcutaneous injection.

When old and thick false membranes become infiltrated with pus, they usually separate in largish masses with more or

less salivation ; on the other hand, in cases in which an active fibrinous exudation is still going on, the fibrinous exudation and coagula are detached and spat out in smaller pieces and in flakes, while in the case of children it is better by means of a thick and soft brush to remove them together with the viscid mucus and saliva. As the removal of such exudations very often leads to hæmorrhages, and thus involves the immediate risk of a septic infection, I consider a thorough disinfection by occasional inhalations of 5 per cent. solution of carbolic acid is urgently indicated, and I see them carried out in the manner described above most conscientiously. As in the mechanical separation or chemical solution of the false membrane there is danger, as I have already observed, in cases in which fibrinous exudation is still going on, of a reproduction of the false membranes a few hours after the action of the pilocarpinum muriaticum has ceased, it is necessary in such cases, besides complete disinfection, to apply warmth in order to hasten suppuration.

As the stimulating influence of pilocarpinum extends to the glands of the tracheal and bronchial mucous membrane, it is possible that here also we may get a rapid solution and expectoration of fibrinous coagula, especially after its subcutaneous injection and the administration of an emetic.

As the general value of a therapeutic method, though it may have a scientific foundation, cannot be decided by the result of a few favourable observations, and as the restorative effort of nature is after all a powerful factor difficult to estimate, I would recommend the treatment with pilocarpinum muriaticum, which I have here only sketched, for further investigation. In employing it, however, we have to consider the condition of the cardiac muscle, and in cases where symptoms of a secondary affection of this muscle have been set up, such as a weak, irregular, intermittent pulse, with fear of sudden cardiac paralysis, the preparation must be used with the greatest caution or set aside altogether.

#### 7. *Ulcers in the Mouth and Pharynx.*

The treatment of the various ulcers which occur on the mucous membrane of the oral and pharyngeal cavity depends on the nature and curability of the disease which causes them.

Inhalations of spray may, first of all, be useful for cleansing the ulcerated surfaces. When simple cleansing is not enough, and the suppurating surfaces are the seat of putrefactive processes and parasitic fungi, a thorough disinfection by means of 2 to 5 per cent. solutions of carbolic acid or 4 per cent. solutions of boracic acid is necessary. In inert, torpid ulceration, with unhealthy suppuration and defective granulation, inhalation of solutions of nitrate of silver, of corrosive sublimate, and of iodine will exert an alterative effect upon the ulcerated surfaces and promote rapid granulation and restitution of tissue; this method may be employed alone or combined with the necessary general treatment. Lastly, if the ulcers should be very painful, an attempt might be made to protect them locally by emollient substances—gum, glycerine, oleaginous emulsions, to which opium and morphine may be added—or, if this is not sufficient, irrigation with nitrate of silver, by coagulation of the pus and the production of a silver albuminate in the form of a greyish-white layer, over the ulcerated surfaces, protects the denuded nerve-endings as much as possible from the influence of air and other chemical and mechanical irritation, and promotes the healing process.

#### 8. *Syphilitic Affections in the Mouth and Pharynx.*

Syphilitic affections occurring in the oral and pharyngeal cavity present the same indications for the application of medicinal inhalations as simple catarrhal and parenchymatous inflammations and ulcerations in these parts.

The first thing to be sure of in this case is, whether there is general constitutional syphilis or not, and therefore whether the affection of the mouth and pharynx is only to be regarded as a local manifestation of it, or whether there are no other traces of this disease in the system but this catarrhal and parenchymatous inflammation. In the former case our treatment must be in a general sense antisyphilitic, and local treatment will be only of secondary importance.

The indication for treatment by inhalation will be determined by the changes in the respiratory mucous membranes. In simple catarrh inhalations of solutions of common salt and

sal ammoniac are sufficient, while in inveterate forms, epithelial suppurations, syphilitic plaques, condylomatous excrescences and ulcerations, inhalations of 0·1 to 0·3 per cent. solutions of corrosive sublimate produce the best results. Solutions of iodide of potassium were employed by Waldenburg with remarkable success.

In the second case, where it is generally a question of catarrhal processes with epithelial troubles and chiefly superficial ulcerations in persons previously syphilitic, a simple treatment of the catarrh by means of inhalations of solutions of common salt, common salt with alum, or, according to the symptoms, of alum and tannin, will generally suffice to bring about a rapid cure. These cases are pretty frequent, in consequence of the abnormal vulnerability of the mucous membrane which general syphilis leaves behind, and not unfrequently when such individuals return for the first time to the habit of smoking, or to indulgence in stimulating food and drinks, they suffer from a more or less severe catarrhal angina, which has nothing whatever in common with the former illness.

In more obstinate forms, where these remedies fail, we must employ inhalations of solutions of nitrate of silver or of corrosive sublimate, or resort to the more energetic method of painting the affected parts with strong solutions of nitrate of silver, or with tincture of iodine, or we may have to apply the galvano-cautery, while inhalations of common salt, sal ammoniac, or carbonate of soda in the intervals will be useful.

#### D. DISEASES OF THE LARYNX.

##### 1. *Acute Laryngeal Catarrh.*

What has been said of the indications for the direct application of medicinal agents in acute pharyngeal catarrh holds good in similar affections of the laryngeal mucous membrane.

The first principle to be insisted on is that everything must be avoided which might cause fresh irritation to the mucous membrane. Consequently there must be no attempt to arrest the inflammation by astringent or caustic remedies, and the acute inflammatory symptoms, such as tickling in the throat,

the feeling of dryness and soreness in the larynx, which is even sensitive to the touch from outside, the violent irritative cough with scanty expectoration, must be treated by inhalations of cold air or the spray of cold water. These, and in the later stages inhalations of tepid spray, either alone or in combination with some mucilaginous or narcotic substance, four to six times a day, are the best means of relieving the distressing sensation of heat, dryness, and smarting, and of removing any accumulation of viscid secretions. In still later stages a favourable effect is produced by inhalations of Ems water, sulphur water, of weak solutions of sal ammoniac, soda, or common salt, and not till all symptoms of irritation have ceased is it permissible to attempt, by means of weak astringent solutions of salts of lead, sulphate of zinc, alum, or tannin, or tannin with common salt, the complete removal of the inflammatory changes in the mucous membranes, the injection and swelling, the serous and cellular infiltrations.

Special attention must be paid to the acute catarrhs of the vocal cords, occurring generally in the case of public speakers, singers, &c., from overstraining their vocal organ, and which, if badly treated, may lead to permanent injury of the voice.

When the catarrh has run its course we may administer prophylactically, to guard against a recurrence of laryngitis in subjects who are predisposed to it, inhalations of stronger solutions of alum and tannin two to three times a day in sittings of a quarter of an hour at a time, and by these and other bracing methods, such as cold lotions and frictions, endeavour to reduce the sensitiveness of the mucous membrane itself. I have often employed this method with satisfactory results.

## 2. *Chronic Laryngeal Catarrh.*

Whether the catarrh in the larynx is an extension of a pharyngeal catarrh, or has originated in the larynx itself, the following are the indications for the use of medicinal inhalations:—

1. In simple catarrhs, with hoarseness, a certain amount of cough and scanty expectoration, when the mucous membrane appears more or less of a dark red, or in parts of a dusky bluish

colour, with mucous follicles swollen, and spots of sero-cellular infiltration, but without papillary overgrowth, the mucous membrane presenting an uneven, granular aspect, the vocal cords showing a reddish grey discoloration, or having their margins strongly injected and more or less swollen, we should attempt, by means of inhalations of 0·2 to 0·5 per cent. solutions of nitrate of silver, to induce hyperæmia, and so promote nutritive changes and a more active flow of fluids, by which the infiltrations and accumulations may be reduced. For this object inhalations of nitrate of silver of the above strength must be administered two or three times a day for 10, 12, or 15 minutes at a time, for several days together, or even for a week or two, according to the duration of the malady and the extent of the pathological changes, and when the retrogression of these changes has begun or is more or less advanced, the effort must be made to bring about complete recovery by the application of astringents, such as alum and tannin in solutions of 1 to 2 and more per cent. But it is only in rare cases, when the illness has not been of long duration, those subacute catarrhs with more active inflammatory appearances, the mucous membrane being moist and swollen and of a bright red colour, it is only in such cases that we shall succeed in completely reducing the inflammatory process, the injection and swelling, and at the same time get rid of the hoarseness and loss of voice.

2. If the catarrh is attended with increased formation of viscid mucous or mucopurulent secretion, difficult of expectoration and causing the patient to be perpetually clearing his throat, adhering to the vocal cords or stretching in viscid threads between them, making the voice rough and toneless, the first indication will be to promote free expectoration by liquefying the secretion by means of inhalations of sal ammoniac, common salt, or carbonate of soda, and at the same time to change the quality of the secretion by the action of these salts on the mucous membrane and its glands. As the secretions become thinned and made easier of expectoration, those symptoms dependent on the accumulation of these secretions in the laryngeal cavity, the tiresome tickling in the throat, the constant necessity of clearing it, the weakness of the voice, soon disappear, and we have to consider in the second place how



best to diminish the secretion and remove the catarrhal changes in the mucous membrane by the application of astringent and alterative remedies. This will be best accomplished by continuing for a time the influence of the solvents and by combining them in gradually increasing doses with the astringents, alum and tannin, or by employing solutions of sal ammoniac and alum, or common salt and alum, or common salt and tannin, and when we find there is a marked and progressive change in the quality and quantity of the secretion we may use simple solutions of salts of lead and zinc, alum, tannin, or nitrate of silver, or chloride of iron, and in this way effect a complete cure.

3. If, in consequence of long-protracted catarrh, hypertrophy of the mucous membrane and the submucous tissue has supervened, and thickenings and indurations threaten seriously to diminish the capacity of the larynx, inhalations of solutions of iodine or iodide of potassium have been recommended for the removal of these consequences of existing or previous catarrhal processes, and good results are said to have been obtained by their use. As a rule, however, these changes are more amenable to surgical treatment, and the reduction of the hypertrophied tissues, when it can be done, is best accomplished by the galvano-cautery.

Excrecences and polypous growths which may occur as the product of catarrhal inflammations must be extirpated by direct surgical operation.

### 3. *Ulcers in the Larynx.*

Catarrhal ulcers, such as are not unfrequently observed in long-persistent catarrhal affections, or when these assume an acute and violent form, require hardly any other treatment than that of simple catarrh.

They are for the most part epithelial exfoliations of the margins of the vocal cords without deeper lesion, especially at the processus vocales, but they occasionally spread to the surface of the vocal cords. They generally reach their greatest extent at the margins of the vocal cords; towards the base they are almost always bounded by the subepithelial tissue, which is rarely much eroded.

Inhalations of nitrate of lead or sulphate of zinc, alleviation of the cough by morphine, rest, sparing the vocal organ, moist warm compresses round the throat, and in case of purulent discoloured base slight disinfecting solutions, 1 to 2 per cent. of boracic acid or thymol, or 1 to 2 per cent. solutions of common salt inhaled several times a day, soon cause the irregular, sharply margined, ulcerated surface to assume a more rounded shape, completely fill up and heal without leaving any observable scar.

The fissures and chink-like ulcers which develop chiefly in chronic catarrh on the anterior surface of the posterior wall of the larynx, running longitudinally along the fold, are of a more obstinate character.

In this case also rest, silence, warding off every injury, removal of the cough and other irritation of the respiratory organs are indispensably necessary to healing. To the ulceration itself, if we do not apply such therapeutic means as cauterisation with solid nitrate of silver or painting with concentrated solutions of this salt or strong solutions of creosote or carbolic acid, we must apply alterative and antiseptic remedies, such as inhalations of high percentage solutions of nitrate of silver, 0.5 or more generally 1 to 2 per cent., and irrigations of creosote water, boracic acid, salicylic acid, so as to promote a reactionary activity of the tissue.

When I have obtained thorough cleansing and a benignant appearance of the base of the ulcer by strong solution of boracic acid (4 per cent.) or creosote water, I administer once, rarely twice, in the day inhalations of solution of nitrate of silver of the above concentration for 6 to 8 or 10 minutes at a time, while the ulcer and the whole larynx must be kept as clean as possible by inhalations repeated often 4 to 6 times a day of 2 per cent. boracic acid, 0.2 per cent. salicylic acid or creosote water, from 10 to 15 minutes at a time, according to the secretion from the laryngeal and bronchial mucous membrane. If the ulcer gradually assumes a benignant, clean appearance, if the loss of substance is filled up by healthy granulations, if the jagged margins become more rounded off, or if they draw near to one another and cicatrise, I limit the inhalations of nitrate of silver to every two or three days, without, however, making a change in the cleansing inhalations. If the cicatrisation advances favourably

I employ more active astringents, inhalations of 1 to 1·5 per cent. tannin solutions with 1 per cent. carbolic acid, kept up for 10 to 12 or 15 minutes 2 to 4 times a day, while cleansing and expectoration are promoted by inhalations of weak solutions of common salt.

The treatment may be completed by employing other astringents, salts of lead and zinc, and at the same time we must ward off the accumulation of all impurities or collections of mucus by the use of disinfecting fluids and such as promote expectoration.

Ulcers in other parts of the larynx must be treated on the same principles, if no deeper-seated mischief lies at their root. The general and dietetic treatment must be guided by the condition of the patient in other respects. Therapeutic operations of another kind may also be necessitated by further indications. The treatment of phthisical and syphilitic ulceration will be dealt with under their respective heads.

#### 4. *Parenchymatous Inflammation of the Larynx, Perichondritis, Œdema, and Abscess of the Larynx.*

In these severe affections of the larynx we may, in the earliest stage of the inflammation, in addition to the external application of cold and other local measures (such as blood-letting) and general treatment, employ with great advantage inhalations of cold air, continued as long as possible, and of pulverised iced water hourly, then every 2 or 3 hours for 10 to 15 minutes at a time.

If there is copious secretion of tough tenacious mucus and respiration is impeded, inhalations of carbonate of soda, applied every one to three hours for ten to fifteen minutes at a time, not unfrequently bring about a rapid solution of the mucus, facilitate expectoration, and relieve the dyspnœa. But here again we must be cautious not to employ too early astringent remedies, such as alum and tannin, for in the initial stages of the malady not only do they fail to diminish the swelling, but they cause accumulations, make expectoration difficult by coagulating the mucus, and increase the dyspnœa, dryness, and irritation. It is not till the acute stage is over that the in-

flammation can be attacked with nitrate of silver, and later on a complete retrogression of the inflammatory processes may be expected by the use of alum or tannin.

If the inflammation results in the formation of an abscess, and the apncea reaches such a degree as to necessitate tracheotomy, we must keep the wound cleansed by disinfecting irrigations with carbolic (3 to 4 per cent.) or boracic (4 per cent.) spray, and when the abscess has opened we should give inhalations of these solutions directly through the mouth, about every two hours for twenty minutes at a time, without however neglecting the disinfection of the tracheal wound. If there should be a copious secretion of mucus and pus 5 per cent. solutions of benzoate of soda every two hours for fifteen to twenty minutes at a time will do good service, and may be continued till the abscess closes and normal respiration is restored.

Then, lastly, solutions of alum and tannin will have the effect of completely reducing the swelling and producing firm cicatrisation.

##### 5. *Diphtheria of the Larynx and of the Deeper Air Passages.*

When pharyngeal diphtheria extends to the larynx (v. p. 279), the indications for inhalatory treatment change so far that it is not the disinfection of the affected parts which demands immediate attention, but the removal of the obstruction now narrowing the air passages, and the solution of the false membrane becomes the main object.

It was formerly believed that this object could be fully attained by inhalations of solvent remedies, lime water, lactic acid, carbonate of soda, or carbonate of lithium, but even though we may succeed in obtaining in one case or another a solution of the membranes and their expectoration either in a tubular form or as mucous coagula—and I have observed a number of highly satisfactory results in this way—yet such cases are exceptional, and in by far the greater number the disease will take an unfavourable turn. We may indeed, in addition to the use of dissolving and disinfecting inhalations, try what can be done with pilocarpine (v. supra) and emetics, by which I have of late frequently obtained the solution and

expectoration of large membranes obstructing the larynx and the trachea; but if this result should not rapidly follow, we must, without loss of time, proceed at once to tracheotomy.

The success of tracheotomy depends—

1. On the time at which it is performed; the earlier the more favourable. The less the disease has advanced into the trachea and the bronchi, and the more the patient's strength is maintained, the more hopeful are the prospects of saving the patient.

2. Not less important is the manner in which the operation is performed. The more carefully and cautiously it is conducted, the less danger there is of the development of secondary processes, serious infections of the traumatic margins and of the surrounding cellular tissue, pseudo-erysipelas and septic processes in these parts, leading to a fatal issue.

Lastly, the condition of the disease in the oral and pharyngeal cavity is of the highest importance. The slighter the diphtheritic infection here, the more limited the pseudo-membranous exudation, the slighter the decomposing and putrefactive processes at work in them, the better will be the prognosis for the operation.

Those cases in which the diphtheritic affection has at once attacked the larynx, or where only a few patches the size of a lentil or a pea occur upon the tonsils or the pharyngeal mucous membrane, while the larynx and a part of the trachea is already obstructed by fibrinous exudations, offer the most favourable prospects of a good recovery. If the pharyngeal diphtheria is widely spread, if the tonsils, the uvula, and portions of the palatine arches or the posterior wall of the pharynx are covered with greyish-white speckled membranes, the prospect is proportionably lessened of obtaining a favourable limitation of the deeper affection in the trachea and the bronchi. If decomposition and putrefaction of the thick coriaceous masses in the mouth and pharynx are already in progress, if blood is effused over them, if the breath is fœtid, if the cervical and sub-maxillary glands, as well as the cellular tissue, are greatly swollen and hard, and the adjacent tissues œdematous, tracheotomy is generally useless, or can only afford slight alleviation; the patients generally succumb in a short time to sepsis, even

before the graver symptoms of laryngeal and tracheal stenosis have become prominent.

The chief reason that prognosis is so unfavourable in advanced pharyngeal diphtheria is, that when an opening in the trachea has once been made, the treatment of the pharynx not only falls into the background, but it is very rarely possible to carry it out thoroughly, according to the given rules, on account of the change in the respiratory mechanism and the difficulty which the patient finds in lying down, so that the occasional insufflations, paintings, or attempts at inhalations are not sufficient to produce the necessary disinfection and detachment of the membranes.

When tracheotomy has been performed, the after treatment must be chiefly carried out by inhalations.

We should naturally in this case aim at dissolving the fibrinous masses choking up the deeper air passages by the inhalation of solvents, such as lime water, lactic acid, &c. ; but the results which I have obtained in such cases are, on the whole, unsatisfactory. Perhaps future attempts with more effective remedies may be more successful. But here it must not be forgotten that by the solution of the membranes we have not yet gained any influence over the development and the course of the pathological process, and have only averted an immediate danger threatening the patient's life. Fresh exudations, fresh obstructions of the air passages, which may ultimately cause the death of the patient by suffocation, and septicæmic processes, are not in the smallest degree arrested by this step.

The most favourable results we have obtained after tracheotomy have been by continuous employment of the steam spray-producer, by means of which a 2 to 5 per cent. solution of carbolic acid and a 4 per cent. solution of boracic acid were alternately atomised. The apparatus is kept at work uninterruptedly day and night, sometimes in the immediate neighbourhood of the tracheal aperture or at 10 to 12 centimetres distant, sometimes farther away from the patient. Direct inhalations through the tracheal canula are prescribed 6 to 8 times a day for 3 to 5 minutes, with a 2 to 3 per cent. solution of carbolic acid, or for a somewhat longer time with a 4 per cent. solution of boracic acid.

A 4 per cent. solution of boracic acid was employed for continuous pulverisation day and night, and only varied by pulverisation of 3 to 5 per cent. solution of carbolic acid 6 to 8 times in the 24 hours for  $\frac{1}{4}$  to  $\frac{1}{2}$  an hour at a time and longer, when the disease assumed a marked septic character; the apparatus each time was held at about  $\frac{1}{2}$  to  $\frac{3}{4}$  of a metre from the tracheal opening. In order as much as possible to obviate a diphtheritic or septic infection of the wound from the tracheal mucous membrane or from without, I also had the traumatic margins painted 3 to 4 times a day and oftener with a 2 to 5 per cent. carbolic solution, and especially enforced the most scrupulous cleanliness.

As has been already mentioned, it is of great importance not to neglect the treatment of the diphtheritically affected oral and pharyngeal cavity, after the tracheal fistula has been made. Neglect in this particular, and the reliance of the physician on the fact that respiration has been freely restored, has been fatal to many patients.

The pharyngeal cavity and the larynx, which cannot be reached by inhalations from the tracheal aperture, form an infective focus from which the diphtheritic inflammation may constantly extend to the deeper parts, or a fatal septic contamination originate. As much care as possible must, therefore, be bestowed on these parts, and the treatment must be entirely guided by the principles which direct that of pharyngeal diphtheria (v. s.) By the steam of the apparatus, whose conducting tube the patient takes in his mouth, the particles of the pulverised carbolic solution, even though the patient breathes through the tracheal fistula, are driven deep into the pharyngeal cavity, and even penetrate as far as the upper aperture of the larynx. This penetration is furthered, as Demarquay's experiment (v. p. 40) shows, if in the case of somewhat older children the tracheal fistula is from time to time closed by the finger or otherwise, and the patient is compelled to breathe through the mouth. The inhalations are repeated every 1 to 4 hours and for some 8 to 10 minutes, according to the condition of the patient's strength and the diffusion of the pharyngeal diphtheria. If it should be utterly impossible to carry out the inhalations, the treatment of the

still existing pharyngeal diphtheria must be continued either by cautious introduction of 1 to 2 per cent. solution of carbolic acid by means of a brush or by insufflation by means of a Bergson's or Richardson's pulverisator and careful cleansing. The prognosis takes an unfavourable form in proportion to the difficulty of bringing treatment to bear upon these affections, and death may be caused by septicæmia proceeding from the pharyngeal affection even when the respiration is perfectly free.

As improvement advances, after the dangers of general infection and sepsis are over, and the membranes in the trachea and the bronchi have been dissolved and expectorated, on the eighth or ninth day after tracheotomy, sometimes sooner, we may diminish the frequency of the direct inhalations, limiting them to 2 to 3 in the day, and the application of the boracic acid spray close to the patient is made at longer intervals. The degree of moisture of the air produced by the pulverisation of boracic acid solution is much more equal and constant, and acts more favourably on the tracheal and bronchial mucous membrane exposed to the direct influence of the external air, than when it is produced by other means of maintaining moisture, such as damp sponges or the evaporation of water.

As in pharyngeal diphtheria and other maladies in which large quantities of carbolic acid are used, so here, attention must be directed to the digestive process and the urine, in order, if necessary, to substitute for 12 to 24 hours 4 per cent. boracic acid solution for the carbolic acid inhalations. The absorption of carbolic acid is here greatly promoted by the wound in the throat, and especially when it is painted with strong solutions.

Inhalations of solvents, such as lime water, lactic acid, &c., after tracheotomy have been repeatedly employed with success by Böcker, Burrow, Brösicke, and others.

For the solution of fibrinous coagula formed in the trachea I would recommend also inhalations of neurine, as well as of other ammonium bases, such as tetramethylammonium hydroxide and tetraethylammonium hydroxide in 3 to 5 per cent. solutions; these preparations, in addition to the property of dissolving coagulated albumen and fibrin, have the merit of acting antiseptically. I myself have not yet made sufficient observations to enable me to decide upon the value of these



medicinal agents in the treatment of diphtheria. The same remark applies to the succus caricæ papayæ and papayotine recommended by Rossbach, which are also applicable for inhalations in 5 per cent. solutions and deserve to be carefully tested. The remarks which I have already made on the value of these medicines, by which we can obtain a solution of fibrinous exudations in diphtheritic affections, apply with special force to these last medicinal agents. All that we can obtain by the solution of the false membranes is the setting free of obstructed canals; no influence whatever is exercised upon the further course of the disease.

#### 6. *Croupous Inflammation of the Larynx and of the Deeper Air Passages.*

When in simple croupous inflammation of the larynx and of the trachea fibrinous exudations and stenotic symptoms have been set up, the treatment must be guided by the same principles as in diphtheria of these parts.

In these cases also we may endeavour to promote the solution of the fibrinous exudations and their discharge by inhalations of solvents, especially of papayotine, neurine, and the other ammonium bases, or of the agents more used formerly, lime water, carbonate of potassium, lithium, or lactic acid.

Easy as it is to show experimentally the possibility of such solution, it becomes very difficult in any special case to liquefy the thick layers of membrane and to bring about the expectoration of the loosened masses. And yet it is the only means we possess, except tracheotomy, and it must be attempted, in order to save the patient from death by suffocation. On account of the narrowness of the passages and the deep situation of the obstructing membranes, the inhalations must be administered with the greatest energy and perseverance, at least every half-hour, from a quarter to half an hour at a time, the patient taking the conducting tube of the apparatus in his mouth and inspiring as deeply as possible in a sitting or somewhat raised posture. As the patient must inhale the spray for a long time, it is absolutely necessary that, from the first, care should be taken to place him in the most comfortable position

and to keep him so till the end of the inhalations. Everything depends on the way in which the thing is done, and the strictest application of the method in all its details is indispensable.

If the inhalations do not rapidly accomplish their purpose, an opening in the trachea must be made as the last means of saving life.

After tracheotomy the attempt may again be made to liquefy the membranes choking up the trachea and the bronchi by the inhalation of solvents, so that they may at length be expectorated. At the same time, however, it is always advisable, when the diagnosis is not beyond all doubt, especially as pure genuine croup is so rarely observed nowadays, not entirely to set aside antiseptic treatment, and to combine disinfecting inhalations, especially a continuous spray of 4 per cent. boracic acid solution (v. s., Diphtheria), with the inhalation of solvents. After solution has been happily accomplished or the croupous membranes have been spontaneously separated and discharged, the disinfecting inhalations of boracic acid or weak solutions of carbolic acid must be continued for some time, and later on it may be advisable to exchange them for slightly astringent solutions. The task of treatment by inhalation is generally terminated with the removal of the canula. In some rare cases protracted swellings of the mucous membrane or other catarrhal affections of the larynx necessitate inhalations of astringents, such as tannin, alum, nitrate of silver, sulphate of zinc, by the mouth for some days longer.

The general and other medicinal treatment is guided by the principles of special pathology and therapeutics.

### 7. *Laryngeal Phthisis.*

The appearances which are comprehended under the name of laryngeal phthisis form a series of pathological processes differing from one another, from simple catarrhal inflammation to perichondritis, elimination of the diseased cartilages and the formation of tubercles in the mucous and submucous tissues. All these morbid conditions may offer more or fewer indications for the application of medicinal inhalations, even though the treatment of the affection we are considering is not exhausted by them.

The question whether laryngeal phthisis is curable has, since the publications of Moritz Schmidt, become much disputed; from my point of view, I must answer it decidedly in the affirmative. Another question which arises is whether all the changes, including the more severe forms of the affection, which nevertheless must be admitted to be curable, are dependent on the formation of tubercles in the tissues. This question I must answer decidedly in the negative. The existing microscopic investigations on this question are not decisive; they have been made on the larynx of subjects who had succumbed to phthisis and tuberculosis. Just as peribronchitis, bronchopneumonia and serofulous and desquamative pneumonia are not the result of tuberculosis, but rather lead to tuberculosis, so all the processes comprehended under the collective name of laryngeal phthisis, catarrhal and parenchymatous inflammations of the mucous membrane in different parts of the larynx, ulceration and callous proliferations of the margins of ulcers, inflammations of the perichondrium, secondary œdema, are by no means all dependent on tubercular deposit, but, like the above-mentioned diseases, are connected with the constitutional conditions which are the foundation of the later development of phthisis and tuberculosis. Years ago in two cases I excised the callous margins of ulcers which had formed on the anterior surface of the posterior laryngeal wall, and which protruded into the interior of the glottis like tumours as big as raspberries, and in the most careful examination of series of sections I could not detect a single tubercle. The patients lived for years after. On the other hand I have generally found numerous tubercles after death in the larynx at the spots mentioned. I have always held this fact to be of the utmost weight, and indeed crucial, in deciding the question whether the affections understood by the name of laryngo-phthisis are curable or not.

In three cases of pulmonary phthisis which I was able to keep under my observation for years, from the first laryngeal affection, simple catarrh, to their death, I came to the following conclusions: Catarrhs, ulcers on the surface and along the margin of the vocal cords, erosions in the vicinity of the processus vocales, in one case with spread of the inflammation to the perichondrium of the adjacent arytenoid cartilage and

secondary œdema, healed completely with cicatrisation; the larynx maintained its delicate, graceful architecture with the exception, in one case, of hyperplasia of the mucosa and sub-mucosa remaining after right-sided perichondritis; the small processes of Santorini and Wisberg, the aryteno-epiglottic folds were sharply outlined, and under the mucous membrane the yellow cartilage of the epiglottis, which was quite unaffected, was easily recognisable. -But only a few months before the death of the patients the form changed with extraordinary rapidity. Extensive swelling of the whole of the laryngeal mucous membrane appeared; the epiglottis was metamorphosed into a thick, almost immovable mass, three times as thick as natural; the aryteno-epiglottic folds formed thick, roundish cords, which appeared to pass directly into the epiglottis; the processes of Santorini and Wisberg had coalesced into one mass, which was separated from that on the other side only by a narrow indentation behind. The false and the true vocal cords, the former projecting to some extent above the latter, were very much swollen and narrowed the glottis very considerably. One patient succumbed six weeks after these sudden changes in the larynx, the two others about three months later, to advanced pulmonary tuberculosis.

In these cases we can accurately date the development of tubercles in the laryngeal mucous membrane from the moment when the whole larynx became transformed by the development of the final pathological appearances. The earlier affections distinctly coming under the head of laryngeal phthisis, and which were cured, we must refer to those causes which also lie at the root of inflammation of the perichondrium of the bronchial cartilages and of broncho-pneumonia. Further observations must teach us to what extent a mucous membrane can be healed that has become the seat of partial tuberculous infiltration and subsequent caseation, suppuration, and ulceration.

As, then, we maintain that laryngeal phthisis is curable, we shall be obliged to assign a large field of activity to inhalatory therapeutics in the treatment of these affections. But the pathological condition of the lung will materially influence the indications as well as the mode of carrying them out. Of course here, as later on in the treatment of pulmonary phthisis,

inhalations will form only a part of the whole treatment, which will be completed by internal, general, and dietetic as well as local treatment of other kinds.

(a) *Acute and Subacute Catarrh.*

Inhalations of cold air are decidedly advantageous in acute and subacute catarrhal, erythematous inflammation of the laryngeal mucous membrane, attended with heat, dryness, and pain. When there is a copious secretion from the bronchi and lungs, which more or less covers the laryngeal mucous membrane, if during expiration mucus is projected through the chink between the arytenoid cartilages, and is drawn in again during inspiration, then inhalations of cold water, of solvent and disinfecting fluids are to be selected and the mucous membrane irrigated with them as much as possible. Solutions of sal ammoniac, common salt, Ems water, are here well adapted for inhalations, and may be ordered several times in the day. An earnest warning must here be given against the premature application of astringents, to which practitioners are so frequently tempted by the false supposition that they can thus cut short the illness, whereas for the most part they cannot be borne at all and only aggravate the symptoms by their irritating effect. It is only in later stages, when the symptoms of acute irritation are gone by, that solutions of 1 to 2 per cent. tannin with 1 per cent. carbolic acid are of essential service. Also inhalations of acetate of lead, or better still of nitrate of lead or of sulphate of zinc, considerably promote healing, especially if there is an abundant secretion from the laryngeal mucous membrane; but where the sensation of dryness, tension, oppression, predominates, astringents, and especially alum, must be avoided. If irritative conditions are prominent, and inhalations of cold air, cold water, Ems water, or slight solutions of common salt cannot be borne, I have generally found emollient vapours and fluids very efficient in bringing about a cure.

(b) *Chronic Catarrh.*

In chronic catarrh, attended with thickening and tumefaction of the laryngeal mucous membrane, attended with hyper-

secretion or with dryness and irritative conditions, the question to be considered in the first instance is, what object is specially aimed at in the treatment of this affection. In such cases it is generally only the intercurrent acute aggravations of the catarrh, in part hypersecretion and irritative conditions, which are accessible to improvement. The feeling of dryness in the throat can also be occasionally removed. We can make but little impression by medicinal inhalations on the thickening and tumefactions of the mucous membrane, which depend less upon infiltrations than upon hyperplasia of the connective tissue or the vocal disturbance arising out of them; nor, indeed, can we obtain any particular benefit by any other methods, and we must therefore content ourselves with palliative measures. For this purpose we may employ with advantage solutions of tannin with carbolic acid, of tannin or alum with common salt; we may also succeed in overcoming the distressing symptoms which occur from time to time by inhalations of sal ammoniac and common salt or alkaline mineral waters (cf. supra, Chronic Laryngeal Catarrh).

(c) *Ulceration.*

The greatest caution is necessary when tissue-disintegration and ulceration occur in a larynx disposed to phthisis. Unfortunately such patients, instead of being submitted to the most careful treatment, are only too frequently left without any further medical supervision, just because they are phthisical, and it is deemed sufficient to keep them in a kind of incomplete general dietetic régime; special treatment and care are considered no longer necessary for the laryngeal affection. Such conduct is highly reprehensible, and is simply fatal to the unfortunate patients.

When the first signs of an ulcerative disintegration of tissue are observed, the utmost care is required, as in the treatment of other obstinate ulcers, to keep the ulcerated surface clean and to ward off all injurious influences which may irritate the parts adjacent to the ulcer and hasten the disintegrating process, while at the same time we must act upon the general health, the nutrition and sanguification, in order to restore the reactionary capability of the affected parts. Putting out of

view in this place the various medical resources for promoting the healing of phthisical ulcers, as we are not now writing on the general treatment of laryngeal phthisis, but on inhalatory therapeutics, what we have to do is to effect the cleansing of the surface of the ulcer, to stimulate the reaction of the tissue tending to atrophy, to promote cicatrisation, and where irritative conditions are present to reduce or remove them.

1. The surface of the laryngeal ulcers in phthisis is infected in two ways. First, by the respiratory process it comes in contact with a mass of parasitical germs, which undergo further development on its purulent surface, and in various ways give occasion to decomposition and putrefaction, to irritation and renewed disintegration of tissue; secondly, we see only too frequently that the bronchial and cavernous secretions already in different stages of decomposition, when coughed up, adhere to the asperities on the surface of the ulcer, to its jagged and callous margins, and suffer further decomposition. As in the treatment of open wounds and ulcers generally, keeping them clean is the first condition for the healing process. Many a surgeon who is accustomed to keep every wound and every ulcer in the cleanest possible condition and most carefully bandaged, would start back with horror were he to look into such a larynx furrowed and riddled with ulcers and covered with mucus, pus, and ichorous cavernous secretions. We may convince ourselves of what can be done in such a case in a short time by administering, as has just been described, inhalations of benzoate of soda in the quantities recommended by Rokitansky, who was the first to employ them, viz. in the proportion of 1 part of benzoate of soda to every 1,000 of the weight of the body. The large quantities of disinfecting fluid which are here inhaled by the patient and partially expectorated again effect so rapid and thorough a cleansing of the ulcer as cannot easily be obtained by any other method. But a complete cleansing of laryngeal ulcers may be obtained and maintained in a less troublesome manner, though I myself have never seen any ill-effects from long-protracted inhalations of that strength (1,000 to 1,200 cubic metres daily). Five hundred to six hundred grammes of a 5 per cent. solution of benzoate of soda, inhaled in two applications morning and

evening, are almost always sufficient in the most copious secretion from the bronchi and lungs to keep the surface of the laryngeal ulcers clean, and in slighter degrees perhaps the half or the third of the quantities given above suffices for the same object. When the aim is not to eliminate large purulent masses and products of disintegration from the larynx, but only to exercise an energetically disinfectant and antiseptic influence on the surface of the ulcers, the preference will be given to strong solutions of carbolic acid and creosote water. The solutions of carbolic acid which I have used in such cases amount to from 2 to 3 per cent., and are inhaled by the patient, according to necessity, 4 to 6 times a day for 15 to 20 minutes at a time. If the ulcers are less deeply seated, and if their surface exhibits no strikingly discoloured appearance, then inhalations of 2 per cent. solution of carbolic acid 3 to 4 times a day for some 15 minutes at a time are sufficient to cleanse them thoroughly and even to excite them to the benignant granulation. Besides carbolic acid, boracic acid, salicylic acid, thymol, eucalyptol may also be employed in the previously mentioned per cent. proportions.

Of the balsams, those of Peru, copaiva, and Tolu, mixed with half their weight of alcohol, may be administered in inhalations, either 12, 15, or 20 drops in a hot infusion of aromatic herbs, or with hot aqueous vapours, simply by means of a large funnel of lead or pasteboard, 4 times a day or more frequently, for 10 to 15 minutes at a time. I prefer inhalations of pulverised solutions of these medicinal agents, or the vapours of those which are readily volatilisable, to every other mode of application, especially to their insufflation in a pulverised form, because by the inhalations which the patient can perform repeatedly during the day a more thorough disinfection can be obtained and all accumulation of putrid pus or infective bronchial or cavernous secretions can be averted.

2. When a thorough cleansing and disinfection of the base of the ulcer has been effected, while the remedies applied exercise at the same time a stimulating and alterative influence upon the denuded tissue, or when healthy granulations already appear in some places, their development may be encouraged and strengthened by the occasional application of nitrate of



silver, either carefully introduced by the brush or by inhalations of 0·1 to 0·3 per cent. solutions 2 to 4 times a day for 10 to 12 minutes at a time. It is not till the ulcers approach cicatrisation and present abundant granulation, while there is an absence of disturbing pathological changes, such as œdema of the different parts, especially over the cartilages, that astringent agents may be ventured upon, in whatever way applied, by inhalations or by careful manual application, to effect a complete retrogression of the inflammatory processes and the development of a permanent cicatricial tissue. For this purpose inhalations of astringents combined with disinfectants are admirably adapted, such as alum or tannin with carbolic acid, or nitrate of silver alone, in 0·3 to 0·5 per cent. solutions or stronger, chloride of iron, nitrate of lead, or sulphate of zinc in moderately strong solutions, two or three applications daily of 10 to 15 minutes each.

For the application of these and similar medicinal agents in another manner, as well as for further therapeutic measures in this disease, other works may be consulted (cf. also 'Special Pathology and Therapeutics,' 'Laryngeal Affections').

3. If the ulcers are accompanied by very painful inflammatory symptoms, or if they are in places where they are exposed to continual mechanical irritations, as, for instance, on the pharyngeal surface of the posterior laryngeal wall, or on the posterior surface, apex, and the margins of the epiglottis, our object must be to remove or allay these symptoms, and enable the patient to swallow with comfort. This task is one of exceeding difficulty. Even by the internal administration of narcotics or the hypodermic infection of morphine it is only rarely that we can give relief. An attempt may be made to procure temporary alleviation by inhalations of cold air, and strongly refrigerated, emollient narcotic remedies with simultaneous application of ice, compresses of ice, wet compresses round the throat, or, where cold cannot be borne, warm emollient vapours and solutions. But even these are frequently of no avail, and the condition of the patient may become all but hopeless, especially from absolute incapability of taking nourishment. In such cases I have obtained most good from the application by means of a brush of a concentrated solution of

nitrate of silver, or by the inhalation of weaker solutions of 0·3 to 0·5, or even up to 1 per cent. The compound formed by the salt of silver with the albuminates of the ulcerated surface coats over the denuded nerves, which are, at least for the next twelve or twenty-four hours, thus protected from the direct influence of the oxygen of the atmosphere, as well as from mechanical injury. In most cases in which all other means have been tried without effect I have obtained satisfactory results from the action of nitrate of silver. I would especially recommend its application in strong solutions (2 to 3 per cent.) by means of a brush.

Where direct manual application is impossible for one reason or another, weaker solutions than the above percentage one to two, three, or four times a day, according to the necessity of the case, may be brought into contact with the ulcerated surface by inhalation.

(d) *Perichondritis and Œdema.*

When the ulceration has extended from any part of the mucous membrane, from the processus vocalis, from the anterior surface of the posterior laryngeal wall, from the mucous membrane of the epiglottis, or from any other region, to the perichondrium of an adjacent cartilage, thus inducing perichondritis with secondary œdema, inhalatory treatment is no longer of chief importance, but other more energetic measures become necessary to bring about a favourable course and ultimate cure.

M. Schmidt<sup>1</sup> was the first to show that a retrogression of these processes can be effected by bold incisions, repeated if necessary, with the scissors or knife, according to the seat of the affection. I can fully confirm his statements, and have repeatedly obtained very satisfactory results by bold incisions into the diseased tissue. If the incisions are rightly performed, the inhalations of disinfecting and antiseptic fluids again render valuable services, and all the more so the more abundantly muco-purulent secretions are excreted from the laryngeal mucous membrane or from the bronchi and cavities. As in every case, the cleansing of the wound is of great importance,

<sup>1</sup> M. Schmidt on *Laryngeal Phthisis*, address delivered in the Balneological Section of the Medical Association of Berlin.

and promotes a favourable course and rapidity of the healing process. Here again I would recommend, as in laryngeal ulceration, according to the amount and nature of the secretion, the inhalation of large quantities of fluid, 5 per cent. solutions of benzoate of soda, or 4 per cent. boracic acid, or 1 to 2 per cent. carbolic acid; or where more advanced processes of decomposition are at work, and the pus and the secretion have already assumed a putrid quality, I would at once prescribe a 3 to 5 per cent. solution of carbolic acid.

The number and the duration of the inhalations must of course be guided by the quantity and the concentration of the solutions employed, and whereas, when large quantities of fluid are necessary, four to six applications of half an hour each are advisable, with stronger solutions of carbolic acid six to ten minutes four to six times a day may suffice, remembering that, if symptoms of carbolic intoxication should be set up,<sup>1</sup> we must substitute for the next twelve to twenty-four hours boracic acid or benzoate of soda. When the wounds are healed and the swelling is reduced, and the inflammatory process which caused them has ceased, the further treatment will be determined by the general condition of the larynx and of the patient.

(e) *Tuberculosis.*

Nothing is more hopeless than the treatment of laryngeal tuberculosis when general tuberculous infiltration of the mucous and submucous tissue has taken place, as in the cases mentioned above. Partial tuberculosis which after caseation, suppuration, and discharge of single deposits leaves an ulcerated surface, may admit of a more favourable prognosis, if we are to include under this head some of the cases of cure of phthisical ulcers hitherto observed, and the secondary affections of the tissue thus caused must be treated according to the principles already discussed.

In general tuberculous infiltration of the laryngeal mucous membrane only palliative measures can be applied, i.e. the removal of the most prominent distressing symptoms.

The dyspnoea from which such patients not unfrequently

<sup>1</sup> Cf. supra, *Diphtheria of the Pharynx, &c.*

suffer, if it depends rather on obstruction of the glottis by the tuberculous infiltration and thickening of the mucous membrane than on an accumulation of thick viscid mucus in the narrow aperture of the glottis, may be relieved by inhalations of cold air or cold spray, which, according to the recorded experiences of tuberculous patients, is more easily inspired than ordinary atmospheric air.

If the expectoration is difficult on account of the thick, viscid, glutinous sputum, and if this obstructs the already narrowed glottis by firmly adhering to the swollen surface, made rough and uneven by ulceration, then considerable relief may be obtained from inhalations of solvents which promote expectoration, such as carbonate of soda, common salt, common salt with carbonate of soda, sal ammoniac and alkaline mineral waters inhaled in large quantities, four to six times a day for a quarter of an hour, or longer. If the secretion is of a more liquid character, its quantity may be limited and expectoration promoted by tar water inf. turion. pin., or by oil of turpentine in combination with aqueous vapours, or by vapours of tar and oil of turpentine by means of the medicated respirator.

If the sputum has become offensive, if it clings to the jagged ulcerated margins, filling up the hollows and cavities and putrefying, the same thorough disinfection is necessary as in the preceding forms of phthisical affection. Inhalations of large quantities of benzoate of soda are generally more efficacious in such cases than strong solutions of carbolic acid. They liquefy the thick, tenacious secretion better, wash out the larynx more thoroughly, cleanse and disinfect the ulcers, and the patient breathes more freely in the air impregnated with spray than in the ordinary atmosphere, so that the inhalations can be continued longer and do their work more effectually. I have found in several such cases that inhalations of disinfecting vapours by means of the medicated respirator were not so well borne as the spray, and I have recently confined myself to the latter in the condition indicated.

Lastly, the excessive painfulness of the ulcers which result from the caseous disintegration of the tubercles thickly infiltrating the mucous membrane is a grave symptom. Here

again the internal or subcutaneous use of morphine generally affords but little relief. Eating and drinking, swallowing the smallest quantity of water, is followed by intense pain, and patients find themselves in a most desolate condition. Even emollients combined with morphine help us but little in these cases, since they exert no local influence, but, as when given internally, only act through the nervous centres, while the strength of the patient fails rapidly from fever and inanition. The local application of nitrate of silver, either directly by the hand or in inhalations, has yielded me the most satisfactory results, as was also the case in the similar painful phthisical ulcers mentioned above, as under its influence the painfulness of the ulcers was diminished, and the patient was again able to eat and drink. When it is impossible to apply concentrated solutions directly by the hand, relatively favourable results may be obtained by inhalations of 0·2 to 0·5 or 1 per cent. solutions of nitrate of silver several times a day, six to eight minutes at a time. One must have observed the torture suffered by such patients, and have exhausted all the means usually at our command, in order to appreciate the palliative effect of this remedy, even though it may last only for twelve to twenty-four hours.

This brings me to the close of what I have to say for the present on the treatment of this malady, formerly inaccessible to medical science. For further observations on the treatment of the lung affections closely connected with and influencing laryngeal phthisis, v. infra, Diseases connected with Pulmonary Consumption.

### 8. *Syphilitic Affections of the Larynx.*

On the whole the treatment of syphilitic affections of the larynx requires no further consideration than that of similar appearances on the mucous membrane of the mouth and pharynx, so that we need only refer to what has been said above.

Specific changes of the mucous membrane, epithelial opacities, plaques, syphiloma, and ulcers require thorough antisyphilitic treatment, which is promoted by cleansing, disinfecting inhalations, especially by 0·1 to 0·3 per cent. solutions of

corrosive sublimate. Old scars, thickening of the mucous membrane, swellings, cordy enlargements, and conical proliferations of the tissues, which may lead to various functional disturbances of speech and respiration, suffer no change nor retrogression under the influence of inhalents, and must be extirpated by the knife or galvano-cautery.

Secondary or later oft-recurring simple catarrhal affections demand the same curative and dietetic measures as those in the oral and pharyngeal cavity.

### 9. *Neuroses of the Larynx.*

Of the nervous affections of the pharynx and larynx treatment by inhalations is chiefly indicated in paresis of the vocal cords, such as occurs most frequently in young girls, and occasionally in older women and in men, and is called 'hysterical paralysis.' So also rheumatic aphonia, which, like facial paralysis, may occur from chills when the body has been overheated, may be cured or improved by the application of vapours and pulverised fluids. In hysterical paresis of the vocal cords a favourable result may be expected, as I have often found, by steady applications of the inhalations of balsamic vapours, such as bals. tolut. and bals. Peruv., then vapours of oleum terebinth., oleum pin. silv., oleum pin. pumil., &c., combined with aqueous vapours or vapours of aromatic infusions. They may also be employed with advantage in rheumatic paralysis, and lead to a comparatively rapid recovery, either alone or combined with the application of constant or induced galvanic currents. In these latter maladies inhalations of alum and tannin in strong solutions may also be tried, especially when in addition to paresis of the vocal cords there exists more or less catarrh of the laryngeal mucous membrane. The stimulation which these medicinal bodies exercise upon the larynx may also be advantageously employed in many cases of actual hysterical paresis with or without catarrhal affection of the mucous membrane; but we have no sufficiently accurate data for this, and we must not calculate upon the result before making the attempt.

Finally, as pharyngeal and laryngeal anæsthetic inhalations

of medicated fluids have been found useful immediately before the performance of endolaryngeal operations, as by their physical as well as chemical properties they reduce the sensitiveness and reflex excitability of the mucous membrane. Thus cold concentrated inhalations of solution of tannin and alum have been recommended and found useful in various quarters; bromide of potassium has also been favourably mentioned for the same purpose. I myself, however, have failed to obtain satisfactory results from repeated experiments with these and other medicinal agents and methods, an experience confirmed by that of most operators. We do not as yet possess an agent for inducing actual anæsthesia in these organs to any extent. Even the internal administration of bromide of potassium fails to reduce the irritability of the laryngeal mucous membrane to any extent worth naming in most cases where it is needed; twenty grammes of bromide of potassium, which I administered repeatedly to different patients all day long in large doses rapidly following on one another, had not the smallest effect on any of them.

*Cocaine, zinc  
pulverised  
purpose.*

## E. DISEASES OF THE BRONCHI.

### 1. *Acute Bronchial Catarrh.*

In cases of acute bronchitis with high fever and much constitutional disturbance, the patient is, as a rule, too prostrate to carry out local treatment, and it is not till the febrile excitement and general depression of the first few days are over that direct treatment of the diseased mucous membranes is possible.

The same indications which apply to acute laryngitis apply also to the treatment of acute bronchitis when there are pain and a feeling of soreness in the chest, irritating cough, dryness, heat, and difficult expectoration, owing to the viscid nature of the secretion; only, as there is a much greater area of mucous membrane affected, the quantity of the solution inhaled must be increased by increasing the number and duration of the sittings, and by making slower and deeper inspirations. In the earliest stages of the malady either cold air or, according to circumstances, tepid aqueous vapour or tepid spray, alone or in combination with mucilaginous or narcotic agents, must be

applied, but when the temperature is high, and the expectoration is dry and scanty, and discharged with difficulty, inhalations of Ems water or weak solutions of sal ammoniac or carbonate of soda, combined with inhalations of cold air, have a favourable effect. Lewin used the extr. conii maculati to relieve excessive hyperæsthesia with constant tormenting tickling cough, and this at once secured better nights and was followed after several days' application by complete recovery. I have frequently employed the same remedy with advantage in similar cases, in the form of a solution of 0·05 to 0·2 gramme dissolved in rectified spirit and added to 100 grammes of pure water or water containing aqua laurocerasi or to 2 to 2·5 per cent. solutions of carbonate of potassium.

With regard to the use of astringents the same counter-indications apply as in acute laryngitis, but with still greater force, as the bronchial mucous membrane, being in an acute state of inflammation, is far more vulnerable and reacts still more sensitively to premature application of these agents than that of the larynx. Compare also the application of compressed air by means of the transportable apparatus and in the pneumatic chamber.

## 2. *Chronic Bronchial Catarrh.*

The treatment of chronic catarrh of the bronchi, like that of the acute form, does not differ in any essential point from that of the larynx, and, as in that case, the therapeutic measures must be varied according to the various symptoms under which the catarrh arises.

In slight cases, where there is only a simple affection of the bronchial mucous membrane without any tormenting cough, and with only a moderate amount of expectoration which is readily discharged, and the respiration is free, improvement and recovery will often follow the inhalation of medium solutions of alum and tannin, either alone or with common salt. Or we may commence the treatment with the inhalation of weak solutions of nitrate of silver, to excite a somewhat energetic alterative influence on the mucous membrane, and later on we may substitute the above remedies for it, or, if circumstances point that way, such as tendency to capillary hæmorrhages or anæmic conditions,



chloride of iron may be used, which Siegle found even more efficacious in many cases. Lastly, where there is much irritation of the bronchial mucous membrane, the addition of a narcotic, opium, morphine, extr. hyoscyami or conii maculat., may become necessary.

The indications are different, however, when the inflamed mucous membrane secretes only a small amount of viscid mucus, which is expectorated with difficulty and with violent, incessant coughing, and which adheres to the tracheal, laryngeal, and pharyngeal mucous membrane, giving rise to distressing, persistent cough, with hawking and choking, and in many cases can only be got rid of, together with the contents of the stomach, by strong emetics. In such cases the symptoms would only be aggravated and the troubles of the patient increased by the inhalation of astringents, which, by their drying influence upon the scantily secreting mucous membrane and their coagulating effect on the mucus itself, would make expectoration still more difficult. Such treatment, therefore, must not be thought of. The remedies indicated here are those which promote liquefaction of the mucus and moisten the dry mucous membrane, and thus facilitate the expectoration of the viscid, crusted secretion with which it is often covered. Inhalations of common salt and other alkaline remedies are best adapted for this purpose, administered in long, frequently repeated sittings. Simple tepid aqueous spray, if inhaled in sufficient quantity, may also so far dilute the tenacious secretion adhering firmly to the walls of the air passages as to loosen it and render it easy of expectoration, without those long tormenting fits of coughing. The addition of some narcotics, such as opium, morphine, &c., may become more necessary here than in the acute form, and exercise a beneficial influence upon the cough.

On the other hand, bronchial catarrh may be attended with profuse, more or less liquid, greyish-yellow, muco-purulent secretion, which, from contact with atmospheric air and stagnation in the bronchi, may undergo more or less active decomposition, which is immediately made manifest by the foetid odour imparted to the sputa.

### 3. *Bronchorrhœa and Putrid Bronchitis.*

Our first object in treating these bronchial affections is to arrest the processes of decomposition at work in the secretions and remove the penetrating odour in the sputa by the use of antiseptics and disinfectants, and next to diminish the secretion itself and to remove the catarrhal changes in the mucous membrane on which it depends.

There is no doubt whatever that, with due regard to the constitutional and nutritive conditions of the patient, and assuming the absence of other incurable diseases, there is no method of treatment which can exercise a more energetic and beneficial influence upon these processes than that of inhalations. According to numerous observations by experienced investigators these processes of decomposition are originated and maintained by vegetable organisms, the germs of which are present in the air, and when they encounter a favourable soil they develop and vegetate at the expense of the albuminous and other compounds, which undergo decomposition. How far these altered secretions produce a further irritating influence upon the bronchial mucous membrane, and excite in it reactionary phenomena of a distinct kind, still awaits more accurate investigations. Practitioners from the first rightly comprehended the conditions which were influential in bronchorrhœa, and were far in advance of theoretical deduction and the indications founded upon it.

Long ago inhalations of oil of turpentine were largely employed by means of Mudge's apparatus, or of the still simpler contrivance of a jug and funnel, generally in combination with warm aqueous vapours (Skoda), but also in the form of dry fumigations (Köhler), and the results obtained were on the whole favourable. The vapour of tar, previously neutralised with carbonate of potassium, diluted and undiluted tar-water (Waldenburg), also the balsams of copaiva, Peru, and Tolu in the form of pulverised emulsions (Biermer), were employed. These remedies, on the one hand, improve the character of the secretion by arresting or altering the processes of decomposition at work in it, while, on the other hand, they diminish its amount, so that the sputa gradually lose their penetrating odour

and assume more of a muco-purulent aspect, and the quantity secreted and coughed up in the twenty-four hours is considerably decreased. From my own observations, however, the most beneficial effect is produced by carbolic spray; under its influence a rapid change in the profuse, sanguinolent, and ill-smelling secretion takes place, and recovery frequently ensues in a relatively short time.

Kemster also mentions in one of his observations that after three inhalations of carbolic acid solution not only the foetid smell of the sputa disappeared, but also their character altered, and the patient made a rapid recovery. William Tuller has also furnished us with the history of cases which show equally favourable results from the use of carbolic acid in chronic bronchitis.

The strength of the solutions inhaled will depend on the severity of the case and the irritability of the mucous membrane, and vary from 0·5 to 2 per cent. The frequency of the inhalations will also depend on the particular case, four to six times a day or oftener for fifteen to twenty minutes at a time. A stronger solution (10 to 20 per cent. acid. carbol.) may be reduced to spray in a steam apparatus several times in the day and for a longer period, which the patient will not inhale directly, but simply keep within its atmosphere, and respire in the ordinary way, breathing, however, exclusively with the mouth. Continuous inhalations of an atmosphere charged with carbolic acid or with disinfecting vapours generally may be obtained by making the patient wear a respirator inhaler, into the receiver of which the medicated substances, carbolic acid, oil of turpentine, thymol, are introduced, and in which the inspiratory current constantly conveys the vapours to the respiratory organs in larger or smaller quantity, according to their degree of concentration. Curschmann, who was the first to adopt this method in the treatment of putrid bronchitis, obtained highly favourable results with it. The putrid character of the exhalation and of the sputa generally either wholly disappeared or was materially improved by the use of the respirator.

A favourable change could frequently be observed even in the course of the first twenty-four hours; the sputa, instead of

the former penetrating smell, had a somewhat sickly, sweetish odour, or that of the medicinal agent employed. Subsequently the respirator could generally be discarded for hours at a time or during the whole night, and at last even for days together, without any return of the fœtor. An abatement of the fever, so far as it depended on the processes of putrefaction, was also observed from the continuous influence of antiseptic vapours.

The concentration of the vapours and the period of time necessary for their uninterrupted action must depend on the gravity of the case and the idiosyncrasy of the patient. It is advisable not to keep too long to weak solutions, but soon to pass on to a 5, 10, or 20 per cent. alcoholic solution of carbolic acid, or even to the pure crystallised acid itself, and to make the patient wear the respirator for several hours three or four times a day, and later on during the whole day with the exception of meal times, and even a great part of the night or during the whole night. As convalescence advances this period may be shortened, without, however, proportionately reducing the degree of concentration of the remedy, which should be reduced very gradually. Vapours of oil of turpentine or thymol are also, as we have said, well adapted for permanent inhalations in putrid bronchitis, but their influence is not equal to that of carbolic acid.

Lastly, pulverised solutions of salicylic acid, 0.2 to 0.3 per cent., may be used in these cases; or 2 to 4 per cent. solutions of boracic acid or 5 to 10 per cent. solutions of benzoate of soda may be tried; but I am not yet in a position to differentiate the two last preparations with certainty, for want of sufficient personal experience of them.

If, under the influence of carbolic acid and of any of the other medicinal agents, the character of the sputa has gradually improved, and its quantity more and more diminished, and yet a complete cure has not been effected, the further treatment will be the same as in simple chronic catarrh. We replace disinfectants and antiseptics by astringents, or we may at first combine them together, so that by the action of remedies like alum and tannin we may gradually reduce the swelling, softening, and hypersecretion of the mucous membrane and bring it back to its normal condition. Even in cases where complete recovery

seems to be effected by carbolic acid inhalations it will still be advisable, in order to avert the danger of a relapse, to submit the bronchial mucous membrane to the influence of strong astringents.

Rapid cures of cases of putrid bronchial catarrhs have been reported by inhalations of alum, of tar, of common salt (Da Costa), as well as by Traube's plan of camomile inhalations, while Sales-Girons also recommends sulphur water and Biermer lime water in these maladies.

Finally, the indications here given must be modified if in any of the various forms of chronic bronchial catarrh an acute exacerbation, with the disturbances specially attending it, makes its appearance. In such case it is obvious that the treatment must be modified in accordance with the newly developed symptoms, according to the principles which regulate the treatment of acute catarrhs.

As to the infection of undiseased bronchi by the draining into them of ichorous secretions, refer to the sections on gangrene and phthisical corrosive ulcers.

#### 4. *Bronchiectasis.*

The secretion which accumulates in the dilatations and sac-like enlargements of the bronchial tubes, by its constant contact with the atmospheric air and the fermentative germs contained in it, undergoes decomposition in these dilatations, and similar changes occur as take place in bronchorrhœa and putrid bronchitis.

As in those diseases of the bronchial tubes so here our object is the same, viz. to disinfect the secretions decomposing in the bronchiectatic cavities and to promote their discharge, so that we may prevent as much as possible their erosive action upon the surrounding mucous membrane and the absorption of the putrescent masses, and that we may also exercise a favourable alterative effect upon and diminish the abnormal secretory activity of the mucous membrane, which is kept in a constant state of irritation by the reaction of these offensive secretions.

The same remedies which we use as disinfectants and for checking secretion in chronic bronchitis and bronchorrhœa are

to be employed here, and the quantity and strength of the solutions and the number and duration of the inhalations will in this case also be determined by the individual character of each case.

Skoda was the first to recommend inhalations of vapour of oil of turpentine in bronchorrhœa and bronchiectatic affections; the irritant action of these vapours, by exciting energetic fits of coughing, promotes expectoration and helps to evacuate the secretions accumulated in the dilatations of the bronchi. Tar water, creosote, and balsams are also very much used, and the astringents, alum, tannin, chloride of iron, are also recommended by Waldenburg, Biermer, Gerhardt, Niemeyer, and others. Here again I use carbolic acid in the form of pulverised solutions or in that of vapour, inhaled by means of the medicated respirator, in preference to other similar remedies, such as salicylic and boracic acid, without, however, denying their beneficial influence. The degree of concentration of the vapours, and the length of time they should be used, is of course guided by circumstances analogous to those in putrid bronchitis.

Tannin and alum are useful not only for checking the hypersecretion of the bronchial mucous membrane, but also for purposes of disinfection, and the same indications determine their local application here as in chronic bronchitis generally. But under the same conditions I have myself always found more advantage attend inhalations of oil of turpentine and of tar vapours, a more or less thorough disinfection and more rapid decrease of the secretion. Nevertheless in cases for which they may appear adapted, especially when the secretion has lost its putrid character and the sputa have become more muco-purulent, inhalations of 1 to 3 per cent. solutions of alum and tannin may be of benefit.

Even after the amount of secretion has been reduced we must persevere with astringent remedies for a long time, so as to remove as much as possible the catarrhal appearances in the bronchial mucous membrane, the swelling, the serous infiltration, the hyperæmia, and the engorgement. These inhalations are specially useful in the after-treatment of cases in which carbolic acid has been employed, and I have been able to use

them with advantage in many severe cases, after the putrid character of the accumulations had disappeared and the amount of the secretion was diminishing.

Here again we must refer with respect to the infection of the healthy bronchial mucous membrane from retained secretion to the sections on pulmonary gangrene and phthisical corrosive ulcers.

### 5. *Bronchial Croup and Diphtheria.*

Fibrinous exudation in the bronchi may occur as the result of the extension of the process of exudation from the trachea and the larynx in diphtheria and croup, but it may also occur as a consequence of disease of the bronchial mucous membrane itself running a subacute, chronic, or, rarely, an acute course. In both cases we have to do with grave pathological conditions.

In the first form of croupous bronchitis the treatment is the same as in diphtheria and croup, and even in the form which originates within the bronchi we must not expect any better results from local treatment, because of the severity of the malady and the unfavourable position of the parts affected.

The influence which we can bring to bear upon the diseased mucous membrane and the inflammatory products is all the less in proportion to the extent of the fibrinous exudations in the larynx and the trachea; and the deeper the seat of the inflammation the more irritable is the mucous membrane, and the more distressing the dyspnoea. We may attempt, by inhalations of lime water (Biermer), to dissolve the fibrinous crusts which choke up the bronchi, though much if not all the lime of the inhaled lime water is precipitated as carbonate of lime. Instead of lime water and the remedies formerly used, carbonate of potassium, lithium, and lactic acid, we should choose in preference the ammonium bases, neurine, tetramethylammonium hydroxide, tetraethylammonium hydroxide, and especially papayotine in 5 per cent. solution, which dissolve the tough fibrinous cylinders and plugs, and convert them into masses easy of expectoration; still we cannot rely with any certainty on a favourable result. If the disease is diagnosed as one of diphtheritic infection, then, together with the above-mentioned medicinal substances, disinfecting inhalations are also advisable,

especially concentrated solutions of carbolic acid, 2 per cent. or better 5 per cent. solutions, in order at least to attack the original cause of the malady and prevent its spreading farther. This would appear to be the most rational of all modes of treatment. The patient should also breathe the spray of tepid water repeatedly for several hours in the day, so that in ordinary breathing he may constantly inspire the pulverised water, or these indirect inhalations may be supplemented by prolonged direct ones of pulverised water. The spray of weak solutions of carbonate of soda may also be diffused through the room, in which atmosphere the patients should spend many hours.

Although the internal administration of medicine must not be neglected, still great stress must be laid upon direct treatment of the diseased bronchi; for, despite all the disadvantages of the conditions, more is to be expected from local treatment, if the case is amenable to treatment at all, than by the internal administration of solvent and antiseptic medicines.

#### 6. *Whooping Cough.*

If the number of medicinal agents at our command in the treatment of any malady is an evidence how little impression we have hitherto been able to make upon it, then whooping cough is certainly a case in point.

The most various remedies both for internal and local use have been advocated, according as the object was to treat the disease itself or to combat one or other predominant symptom, not to speak of those which were employed empirically without any scientific basis.

Among the earlier observations on the inhalation of volatile substances in whooping cough the most interesting communications are those of Dohrn (1835), in which several cases are recorded as having run a remarkably mild course which were treated by fumigations of olibanum and benzoin. From our present knowledge we may safely infer that the latter was probably the active agent in these inhalations. When the method of pulverising fluid medicines was discovered, a variety of medicinal antiphlogistic and astringent agents were employed, with the view which then obtained of combating the inflamma-



tory disturbances of the respiratory mucous membranes—nitrate of silver (Rohn, Noll, Kretzschmar), alum (Siegle), tannin (Steffen), chloride of iron (Gerhardt, Wedemann)—or solvents and expectorants to promote the liquefaction and discharge of the viscid masses of mucus, so rapidly and profusely secreted—steam of warm water, carbonate of potassium and carbonate of soda (Niemeyer), common salt (Steffen), sal ammoniac and alum (Wietfeldt)—or mucilaginous and narcotic remedies for the relief or arrest of the convulsive paroxysms and the suffocative symptoms attending them, mucilaginous solutions of extract of hyoscyamus (Fieber), tinct. opii with common salt (Steffen), bromide of potassium (Helmke, Gebhard), &c.

The results obtained by the inhalation of these and similar medicinal agents did not, however, much exceed those obtained by internal treatment, and in subsequent reports it has been claimed for them that they diminished the intensity of the attacks, facilitated expectoration, and led to a more rapid recovery from the secondary catarrh; but the course of the malady was not cut short, nor even perceptibly abbreviated, by their means.

We may mention here the popular method of treatment, consisting in the inhalations of coal gas; which appears to have originated in Holland and to have been largely practised in France, where they sent children to gasworks. Keller, who observed the effect of gas inhalations in 39 children during two years, could not ascertain that they exercised either a prophylactic or a specific influence over whooping cough. Indeed, Löchner observed an aggravation of febrile symptoms from this treatment, which justifies our warning the public against further experiments of this kind.

At the 50th congress of German scientific and medical men, held at Munich, Birch-Hirschfeld read a paper on inhalations of vapours of carbolic acid in the treatment of whooping cough. This treatment was first employed in an epidemic of whooping cough at the Blind Asylum at Dresden in 1877, and was conducted as follows: Not only were inhalations of weak solutions of carbolic acid administered from time to time, but the patients were kept constantly in a well-ventilated room, in which an atmosphere charged with carbolic acid vapours was kept up by

frequently sprinkling the chamber with a 20 per cent. carbolic solution, i.e. by pulverisation of the solution by means of the spray apparatus.

This method is based upon the assumption that whooping cough is to be reckoned among parasitic infective disorders, a theory which was previously maintained by Letzerich, and which has been supported by the detection of countless masses of micrococci, of which I have repeatedly convinced myself. Letzerich has also recommended inhalations of atomised solutions of quinine, and claims to have obtained good results from them, while Burchard in 1874 caused children suffering from whooping cough to inhale the vapours of a  $1\frac{1}{2}$  to 2 per cent. aqueous solution of carbolic acid vapourised in a boiler, and the vapours conducted a distance of 20 centimetres by a conducting tube, 3 times a day for 2 to 3 minutes at a time. More recently Thorner treated 16 cases of whooping cough with inhalations of carbolic acid, and in all the cases succeeded in considerably shortening the attack. In every case a slight bronchial catarrh remained behind after the cessation of the actual symptoms of whooping cough, but it soon yielded to the ordinary treatment. Thorner never saw an instance of the third stage of whooping cough, that of profuse mucous expectoration, when treated with carbolic acid. On the other hand, the remedy seems incapable of exercising a prophylactic influence. The inhalations were prescribed by Thorner in this manner: Older children inhaled a 1 to 2 per cent. aqueous solution of pure carbolic acid at about the distance of a metre from the aperture of exit of the vapourising apparatus, while small unmanageable children, or those whose larynx or bronchi were unduly sensitive, were kept for some 20 minutes in a small room with window and doors closed, in which about 160 to 240 grammes of the same solution were pulverised, and thus the air of the room impregnated with carbolic spray.

Thorner showed very beautifully in the curves given in his communication the course of the malady under the influence of inhalations of carbolic acid.

I myself have tried carbolic acid in whooping cough in nine cases, and certainly obtained far more favourable results than with the method hitherto employed.

The youngest of these patients was my own little daughter, 1¼ year old, who was laid low by the most violent symptoms, rapidly succeeding paroxysms and fits of vomiting. Inhalations of a 5 per cent. solution of carbolic acid were ordered in the following manner:—

A small space about 1½ metre in diameter in the child's room was shut in by Spanish screens, and washstands hung with carpets and cloths; the child and her nurse were placed in this, and a 5 per cent. solution of carbolic acid was pulverised for an hour, at a distance of about one metre. The treatment was repeated four times in the day, while the child was kept the rest of the time partly in the same space, partly in the same room. On the first day of the inhalations the symptoms increased and on the second reached their climax. From that time there was a rapid decrease of them; the paroxysms diminished in number and in violence; the frequent vomiting which had already disturbed the child's nutrition became less frequent, and disappeared, together with the paroxysms, after eight days' steady application of the inhalations of carbolic acid. Also the bronchitis, which persisted for about three weeks longer, decreased rapidly in intensity, and the child's general health improved from day to day.

Neither Birch-Hirschfeld, Thorner, nor I observed any ill effects from the action of carbolic acid. Carbolic urine very rarely occurred. Still I consider frequent inspection of the urine to be indispensable; if it shows discoloration the remission of the inhalations for the next twenty-four hours is quite sufficient for the excretion of the carbolic acid from the blood.<sup>1</sup>

<sup>1</sup> My own experience of the treatment of whooping cough by means of carbolic acid coincides with that of Oertel. But the treatment must be carried out with great *thoroughness*, or it will be discredited by the results. The child or children should be put in a *small* room containing a fireplace, and from time to time pure carbolic acid should be vapourised by dropping it upon a hot metal plate or spoon, until the atmosphere of the room is strongly charged with the vapour. For direct inhalation I use every hour or two, for fifteen minutes at a time, a spray of 1 dram of glycerine of carbolic acid and 10 grains of carbonate of soda to an ounce of hot water. However young the child may be there is no difficulty in keeping this spray constantly playing in front of his mouth and nose, so that he is compelled to inhale it in part at least. I also cause a spray of a 5 per cent. solution of carbolic acid to be frequently diffused through the room, and especially over and around the bed.

As regards other antiparasitic agents, it would appear from Birch-Hirschfeld's experiences that salicylic acid cannot be substituted for carbolic acid; on the other hand, that benzoic acid, whose antiseptic properties have lately been lauded, is indicated in whooping cough. Thymol and benzoate of soda should also be subjected to a more thorough investigation.

### 7. *Emphysema and Asthma.*

The changes of form and texture which are determined in the lungs by emphysema are not capable of removal by medicated inhalations. It was at first supposed that, as treatment of this malady by inhalation was attended sometimes by excellent results, it might also exercise a favourable influence upon the pulmonary tissue by the subsidence of the attendant and causative processes, especially of the bronchial catarrh. There seemed all the more reason for thinking so because, by the inhalation of judiciously selected remedies, the respiration of the patients appeared to be really improved and the existing expiratory insufficiency diminished, and so much so that the dyspnoea in many cases disappeared spontaneously or only recurred when more active exercise was taken. Yet relief of symptoms was all that was obtained, and no real influence upon the emphysema could ultimately be detected. Nowadays the pneumatic method only is employed in the treatment of the dilatation of the pulmonary vesicles dependent on diminished elasticity of the lung-tissue which Biermer has termed pulmonary flatulence,<sup>1</sup> and which is attended with expiratory insufficiency, while the treatment of the catarrhal affections in the bronchi and of the asthma is allotted to inhalations.

The treatment of the catarrh which accompanies emphysema must of course be guided by the same principles which apply to the treatment of bronchial catarrh generally, and the selec-

Oertel's modification of Siegle's steam spray producer is very handy for this purpose.—TR.

<sup>1</sup> Without being aware that Biermer had used this term *pulmonary flatulence*, I called attention, in an article I published in the *Practitioner* on the 'Treatment of Asthma,' to the analogy between the distension of the lung observed in these cases and the *flatulent* distension of the abdomen observed often in hysterical conditions.—TR.

tion of medicines is chiefly determined by the indications presented by the more prominent symptoms.

In the usually chronic course of the catarrh, occasionally interrupted by acute exacerbations, and in the generally abundant secretion of viscid, mucous secretion, which is very liable to decomposition, especially when cylindrical or sacculate dilatations of the bronchi have already taken place, those ethereal oils which limit secretion and act as disinfectants must be employed, viz. oil of turpentine, oleum pin. silv. and pumil., oleum junip., oleum cadin., and in more advanced and putrid decompositions tar water, creosote water, or carbolic acid. Inhalations of the ethereal oils in most cases relieve the dyspnoea of patients even while they are being administered, and the occurrence of asthmatic complications may be long deferred, though, if they once occur, the inhalations have no control over them. When the expectoration is scanty and difficult, we recommend inhalations of pulverised solutions of common salt, and in acute or exacerbated catarrhs of sal ammoniac, carbonate of soda, and of the alkaline, muriatic, and saline muriatic springs of Ems, Neuenahr, or in the case of erethic patients the cold alkaline springs of Selters, Salzbrunnen, Fachingen, or the saline springs of Reichenhall, Kissingen, Soden, &c., while the brine vapours may act as irritants in dry catarrh and are better adapted for bronchorrhœic conditions.

Where the secretion is more profuse, astringents, such as alum and tannin, may be administered by inhalation either alone or in combination with ethereal oils, but their action is less effectual in this case, as the dyspnoëic conditions may be aggravated by them. It will therefore be more advisable in cases of bronchorrhœa to keep to oil of turpentine or tar water. Great dyspnoea may necessitate narcotic inhalations, especially infusions of hyoseyamus, belladonna, or stramonium alone or combined with oil of turpentine and the solvent salts (Waldenburg). Arsenic in the form of Fowler's solution has also been recommended in these cases by Lewin and Wistinghausen.

There are four theories as to the nature of asthma, by which we mean periodic, paroxysmal, severe dyspnoea, in which the expiration especially is embarrassed, and which occurs either as essentially idiopathic in otherwise healthy subjects or in a

symptomatic form, as a complication of emphysema, chronic bronchial catarrh, and cardiac affections.

According to the first theory, that of Biermer, bronchial asthma depends on spasm of the bronchial muscles, while the second (Bamberger) refers it to a tonic cramp of the diaphragm, the third to both these conditions combined (Lebert), while, according to a fourth theory (Th. Weber), the symptomatic form of bronchial asthma is to be explained by an acute swelling of the bronchial mucous membrane in consequence of dilatation of its blood vessels by vasomotor nervous influences. It is in favour of this last theory that Lovén, by irritating experimentally the sensory nerves, succeeded in exciting a reflex congestion in the sphere of the irritated region, and then, again, neither cramp of the diaphragm nor of the bronchi can sufficiently account for the mucous secretion at the end of an attack of asthma. Störk also supports this theory, and our observations and experiences also tend to confirm it.

In considering the causes of bronchial asthma as a neurosis of the vagus, either occurring of itself or in combination with catarrh of the respiratory organs, we must, especially in connexion with inhalatory therapeutics, note Leyden's view that the fine, pointed crystals first found by Charcot in the sputum in a case of bronchial asthma excite an irritation of the peripheral terminations of the vagus in the mucous membrane of the bronchioles, and so induce a reflex cramp of their muscles. I myself have had frequent opportunity of observing these colourless, faintly lustrous, pointed octohedral crystals (fig. 17) in the profuse, viscid, greyish white, hyaline, and very frothy expectoration which follows an asthmatic attack. These crystals are soluble in water, in acids and alkalies, insoluble in alcohol, ether, chloroform, and solution of common salt,<sup>1</sup> swell up in glycerine so as to be unrecognisable; they

FIG. 17. no doubt originate in decompositions of the mucine or mucilaginous substances going on in the bronchial secretion. Leyden mentions the occurrence of certain schistomycetes simultaneously with these crystals, and suspects that

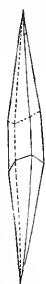

FIG. 17.

<sup>1</sup> Dr. Ph. Schreiner on 'A New Organic Basis in Animal Organisms,' Liebig's *Annals of Chemistry*, vol. xciv. p. 68.

their formation may be connected with decompositions initiated by these fungi. I have succeeded in ascertaining, by direct observation and cultivation under the microscope, the dependence of the formation of these crystals in the bronchial secretion on the germination and multiplication of these fungi. The fungi themselves appear as roundish micrococci about  $\frac{1}{10000}$  millimetre in diameter, either single or generally in colonies, and multiply pretty rapidly in a room heated to 16° to 18° C. In a small drop of bronchial secretion, in which only a few fungi and no crystals are found on the object glass, we may observe after 24 to 48 hours, if we carefully prevent aqueous evaporation and the entrance of other bacteroid germs, widely spread colonies of micrococci, within which, either immediately or after some time, the crystals form, at first small, afterwards increasing in size. If the observation is prolonged perhaps 24 hours or longer, these crystals are found in profusion free in the fluid, even outside the masses of micrococci. In a drop of mucus from the same sputum in which no fungi of the kind were present, or at least not developed, no crystals formed; their formation was not even excited by slow evaporation of the fluid; I also failed to obtain them when spores of other fungi from the atmosphere, especially septic bacteria, lodged themselves in large numbers on the drop of mucus; the crystals even disappeared if they had been previously present in a preparation.

Treatment by inhalations, again, form but a part of the general treatment of asthma, which must be determined by the causes as well as by the most prominent symptoms. During the actual paroxysm we may try to relieve the oppression as much as possible, or to remove it, by inhalations of cold air, according to the above directions (v., p. 109), or by inhalation of narcotic substances. The most generally known and employed are those included in the *Materia Medica*. An attack which is not too far advanced may frequently be cut short or alleviated by smoking stramonium leaves, stramonium cigars, cigarettes of Indian hemp, cigarettes d'Espic, which are prepared from a composite extract of belladonna, hyoscyamus, stramonium, cœnanthe phellandrium, and opium. A similar effect is produced by fumigations of nitre paper, or paper that

is saturated with both nitre and narcotic substances, more especially Neerland's charta antasthmat. and the tub. antasthmat. introduced into commerce by Levasseur.

When I recall to mind the numerous cases treated by various methods, I have really only seen rapid and effectual relief, a complete removal of the asthmatic attack, in those cases in which the inhalation of the dense white smoke evolved from these preparations led to a profuse expectoration of serous or viscid vitreous, mucous massès. As soon as the smoke of such a cigar or cigarette, or a tub. antasthmat. or nitre paper, was drawn deep into the lungs according to the Turkish manner of smoking, there followed instantaneously a sudden fit of coughing, which always evacuated a large quantity of this mucus. If the violence of the attack interfered with deep inspiration of the smoke, no impression was made on the intensity or the course of the attack. Even simple tobacco-smoking produced the same nauseating and expectorant effects on persons who were unaccustomed to it. Slight dyspnoëic troubles, such as occur so frequently with asthmatic subjects during the night, are generally alleviated by burning pastils, nitre paper, &c.

In addition to these remedies two to three drops of amyl nitrite, dropped on blotting-paper or linen and inhaled, may produce a momentary alleviation of the attack, but fail to cut it short. Ethyl iodide, inhaled up to 10 to 15 drops 6 to 8 times a day, in the same way as amyl nitrite, exercises a similar influence upon the asthmatic attack. Then, again, Demme employed, especially for children, inhalations of meythl bichloride up to 8 to 10 drops, either pure or combined with chloroform, and considered that it affected the circulation less than other anæsthetics.

Lastly, inhalations of chloroform and ether, stopping short of narcosis, have been employed for a long time. But in the application of this agent also in most cases I have seen no actual relief or cutting short of the attack, unless it led to the expectoration of a large mass of bronchial secretion.<sup>1</sup>

<sup>1</sup> I have repeatedly seen the most severe attacks of asthma 'cut short' by the hypodermic injection of a solution of morphine and atropine before the occurrence of any amount of expectoration, and this I know has been the experience of others.—TR.



Leyden employs inhalations of common salt and carbonate of potassium, 1 part of each to 100 parts of water, for dissolving the crystals which are found in the bronchial secretion evacuated during the asthmatic attack, and which, if they do not originate the attack, certainly act as irritants on the sensitive mucous membrane. But 2 per cent. solutions of carbonate of potassium or sodium would be better, as Schreiner states that the crystals are insoluble in solutions of common salt. If a result is to be obtained, the inhalations must be administered either immediately upon the first signs of incipient asthma or some time beforehand, in order to prevent the formation of the crystals, which is the assumed cause of asthma, while at the same time the action of the alkali tends to liquefy the excessively viscid mucus and to facilitate expectoration. In some cases I have found these inhalations beneficial; in others they have proved ineffectual.

Pneumatic treatment by either partial or general pressure cannot always be tolerated during the asthmatic attack; yet dyspnoëic troubles are sometimes considerably relieved by inhalations of compressed air or alternate inspirations of compressed and expirations into rarefied air, as well as by keeping in the pneumatic chamber. In some cases of asthma with scanty secretion and transudation, which generally imply simple spasmodic contraction of the bronchi, this treatment is not borne.

Indication for the application of pneumatic therapeutics is determined chiefly by the changes in the lungs at the root of the asthma or complicating it (cf. Part II.)

## F. DISEASES OF THE LUNGS.

### 1. *Inflammation of the Lungs.*

1. *Catarrhal and croupous pneumonias* do not in themselves offer any indication for the local application of medicinal agents either in the form of vapour or spray. The high fever, the uneasy decubitus of the patients, and above all the extreme vulnerability and irritability of the inflamed lung, counter-indicate every mode of treatment which could excite any increased inflammatory reaction in the lung.

The behaviour of the lung is in this case analogous to that of the other, usually even less sensitive tissues of the respiratory tract, the laryngeal, tracheal, and bronchial mucous membrane in acute inflammatory conditions (cf. Bronchial Catarrh). All suggestions of alkaline, or, worse still, astringent inhalations, are founded upon inaccurate theoretical considerations.

There is, however, one indication, and only one, for the use of chloroform inhalations in treating the symptoms which may arise, and that is under the following conditions.

When a large portion of the lung is rendered useless by inflammation as well as by collateral fluxion, and therefore only a small portion of the pulmonary surface is left available for respiratory purposes; when, moreover, the respirations have become frequent, short, and shallow on account of the extreme pain in inspiration, through implication of the pleura, the decarbonisation of the blood becomes more and more faulty, and cyanosis is rapidly developed; then repeated inhalations of chloroform, stopping short of complete narcosis, are undoubtedly beneficial. Junker's apparatus is well adapted for these inhalations, as by its employment unpleasant irritation and spasmodic excitement are better avoided than by simply holding a handkerchief before the mouth. The patient inhales calmly and continuously an equal mixture of chloroform vapour and atmospheric air, without any fear of too rapid and dangerous narcotisation. Under the influence of chloroform the pain attending the inspirations gradually diminishes and they become deeper, the frequency of respiration is lessened, and the exchange of gases proceeds freely; the cyanosis disappears, and the danger which threatened from insufficient respiration may be kept at bay till the crisis is past and the respiration becomes free again with the rapid decline of the fever and solution of the exudations.

I have observed this treatment in a great number of cases, partly while clinical assistant to the late Dr. v. Pfeufer, partly in my own private practice, and I have always obtained favourable results in suitable cases.

Partial narcotisations by means of chloroform inhalations must be frequently induced, as often as the indication occurs, under the direction of the physician himself, 2 to 4 or 6 times

in the day. Attempts to treat pneumonia from the first with chloroform inhalations have naturally led to no result, as the influence of chloroform is powerless to arrest the inflammation itself.

2. *Interstitial pneumonia*, according to the symptoms which it sets up in the lungs during its course, repeatedly presents indications for the use of local remedies.

(a) The *cirrhotic process*, which on the one hand, by retraction of the pulmonary tissue, leads to atrophy, and on the other to emphysematous inflation of the adjacent parts, is only partially amenable to mechanical treatment. By the alternate influence of inspirations of compressed air and expirations into rarefied air, a re-expansion of the collapsed portions of the lung and a restoration of the emphysematous portion, if it is at all capable of restoration, may be effected, for which purpose Geigel and Mayer's double ventilator is best adapted. The gasometer apparatus and Biedert's bellows apparatus (v. Part II.) may also be used after combining the two apparatus into a double apparatus, alternately for inspirations and expirations, or, if they can only be used separately, employed for intermittent respirations.

This method of treatment must be employed with caution, for fear of hæmorrhage, and it will therefore be well not to allow too great a negative pressure to be employed in expirations into rarefied air, and if hæmorrhage has already occurred to restrict the treatment to inspirations of compressed air only. The special pneumatic chamber, in producing expansion of the pulmonary tissue, affords reason to expect favourable results from its use in the treatment of chronic interstitial pneumonia.

Lastly, we must also take into account the changes in the fulness of the pulmonary vessels which are caused by the alternate changes of pressure to which they are exposed through compressed and rarefied air, and the favourable influence this exerts upon the nutrition and the tissue-changes in the diseased tissues, and so materially aids the effect of the mechanical treatment.

(b) If *bronchiectatic dilatations* have taken place, with their attendant symptoms of ulceration, stagnation, and decomposition of the products of ulceration and of the bronchial

secretions within them, inhalations of antiseptic and disinfectant agents must be immediately commenced, and the same treatment adopted as in putrid bronchitis and bronchiectasis.

According to the character of the expectoration, inhalations of oil of turpentine, tar water, tar vapours, or 2 to 3 per cent. solutions of carbolic acid must be administered in sittings of  $\frac{1}{4}$  to  $\frac{1}{2}$  an hour 4 to 6 times a day, and the internal and dietetic treatment will be guided by the other concomitant symptoms and indications.

If the processes of decomposition have not reached too high a degree, and if they do not necessitate the energetic application of strongly disinfecting agents, then inhalation of these vapours may be combined with the inspirations of compressed air, and thus both indications may be fulfilled at the same time (cf. Part II.)

3. *Desquamative pneumonia, caseous lobular pneumonia, and broncho-pneumonia*, as the pulmonary affections which most commonly lead to phthisis, also require in part, and as far as is possible, careful local treatment by inhalations of medicinal substances as well as by the employment of the various alterations of air pressure by means of transportable apparatus and the pneumatic chamber. On account of their direct connexion with pulmonary phthisis we must reserve a fuller discussion of them for the section on that subject.

## 2. *Pulmonary Gangrene.*

When gangrenous disintegration of larger or smaller portions of the lung tissue has set in, energetic application of antiseptic and disinfecting agents directly to the gangrenous parts is urgently indicated.

Local is here of more importance than general treatment, and the remedies applied in the form of vapour and of spray have hitherto been attended with the most favourable results.

The first case of recovery from pulmonary gangrene by persistent and energetic inhalations of chlorine was published by Stokes.<sup>1</sup> The case was one of a drunkard, who after a chill had suffered from pains in the chest, shortness of breath,

<sup>1</sup> Stokes on *Diseases of the Chest*.

hectic fever, and cough, with dark and bad-smelling expectoration. The odour of the breath was very unpleasant and the stethoscope detected a cavity in the left lung. The patient was ordered a nourishing diet, wine, and inhalations of chlorine, and improvement very soon followed. Within 2 or 3 days the offensive smell had disappeared, but when the chlorine inhalations were left off it instantly returned, but disappeared after renewed application of them.

The second case of any importance after that of Stokes, which again drew attention to the direct use of stimulating antiseptic agents, was that of Skoda.<sup>1</sup>

The patient, a robust man-servant thirty-three years of age, presented on percussion an area of dulness extending from the right clavicle downwards to the fourth intercostal space, front and back; hence to the base of the thorax resonance was tympanitic; the liver was lower down; in front and behind auscultation over the area of dulness gave amphoric resonance and metallic clang in breathing, speaking, and coughing. The left side of the thorax showed nothing abnormal. About two pints of a yellowish green expectoration partly streaked with blood were discharged daily by coughing. The lecture room, in which the patient lay, was filled with a frightful stench, which every cough increased. After all the remedies that were applied had failed, Skoda tried inhalations of turpentine, poured upon boiling water and inhaled by the patient by a Mudge's apparatus. The inhalations of oil of turpentine did not produce any irritating effect upon the patient's lungs, and appeared to give him relief; the urine had the usual odour of violets after the first inhalations. Quinine and opium were administered internally. On the twelfth day the tympanitic sound over the lower lobe of the right lung and the danger of its spread had disappeared; dulness and amphoric resonance were still present above. Skoda thought the cavity was about the size of the fist. The improvement persisted, the area of dulness decreased from below upwards, the amphoric resonance disappeared, the sputum lost its fœtid character and became at last very slight. When the patient was dismissed by his own wish, the breathing was thoroughly vesicular, the percussion normal, the sputa slight.

<sup>1</sup> Skoda, *Wiener med. Wochenschrift*, vol. xv., 1852, p. 231.

It could not be satisfactorily ascertained whether the cavity was completely closed; at any rate it was considerably reduced in size, and there is no doubt that, with due care, it would ultimately close altogether.

We have now a series of cases reported of pulmonary gangrene which have run a favourable course under treatment by antiseptic and disinfectant inhalations.

Carbolic acid is, again, the agent most recommended for these inhalations in high per cent. solutions (2 to 5 per cent.) six to eight times a day, according to their degree of concentration and for five, ten, or fifteen minutes at a time. If the urine assumes an olive green colour during these inhalations, the carbolic acid may be suspended for twenty-four hours and replaced by oil of turpentine or an infusion of young pine-shoots (15·0 to 150·0 or 200·0), or oleum pin. silv., oleum cadinum, &c. The continuous inhalation of carbolic acid or oil of turpentine is indicated here even more decidedly than in putrid bronchitis and bronchiectasis; as before, the best mode of carrying them out is by the medicated respirator. We must of course use a higher degree of concentration of the vapours in accordance with the gravity of the disease, and their action must also be prolonged more than in other maladies of a putrid character (v. *infra*, Putrid Bronchitis). Besides these remedies we may employ inhalations of 5 to 10 per cent. solutions of benzoate of soda, of which 800 to 1,000 grammes should be inhaled within twenty-four hours, creosote water or permanganate of potassa, salicylic acid, thymol, bromine, oxygen (Leyden), and they should be employed in highly concentrated solutions.

In the treatment of pulmonary gangrene the object is not only to disinfect the gangrenous spots and stop any further advance of the destructive and septic processes, but also to abolish the erosive influence of the gangrenous ichor upon the whole bronchial mucous membrane. As in putrid bronchitis with decomposing, putrescent contents of bronchiectatic dilatations and cavities, so here specially mischievous results may arise if, owing to incomplete expectoration, a portion of these sputa which still remain clinging to the walls of the trachea and the bronchi flow back later on either into healthy bronchi or are drawn into healthy parts of the lungs and there create

fresh inflammation and destruction of the pulmonary tissue. Therefore in severe cases the most thorough disinfection is of primary necessity, and inhalations of carbolic acid are likely to be most efficient. In such cases I consider it necessary not only that the patient should inhale those high per cent. carbolic solutions at the times stated, or weaker solutions, 2 to 3 per cent., hourly and half-hourly for a longer or shorter time, according to the height of fever and the strength of the patient, but that he should be kept constantly in an atmosphere of carbolic spray (5 per cent. solution), and also in ordinary breathing he should inhale particles of carbolic acid suspended in the air of the room. This is the only way in which a sufficient amount of carbolic acid can be taken into the lungs, to antagonise as much as possible the destructive processes and bacteroid vegetations at work in the gangrenous pulmonary tissue and to deprive the sputa of their infective and erosive properties. By this continuous pulverisation, again, the air of the room itself will be disinfected, and the smell, unbearable alike for the patient and his attendants, will be at the same time diminished or entirely removed. Of course the employment of the medicated respirator is not excluded in all this. It may be mentioned lastly that Trousseau used tannin with apparently favourable results.

The general internal and dietetic treatment must be determined by the rules of special therapeutics, according to the individual case.

### 3. *Diseases connected with Pulmonary Consumption.*

The indications for the employment of inhalations in the pulmonary affections connected with phthisis will be determined by the special pathological processes present and by the symptoms to which they give rise.

A great complex array of pathological processes in the larynx, the trachea, the bronchi, and the pulmonary tissue which here make their appearance unmistakably demands the application of directly acting remedies; physicians have felt this in every age, and have striven according to their knowledge and ability to make way against the destructive processes de-

veloping in the lungs. Quite recently these attempts have been renewed with the resumption and development of inhalatory therapeutics, and medical literature abounds in interesting observations and remarkable results.

According to the present views of the nature of tuberculosis, we must attempt, by the direct influence of medicinal substances and by way of prophylaxis, to gain command gradually over the various phases of the morbid processes as they develop themselves, over the catarrhal affections of the larynx, the trachea, and the bronchi, over the graver processes in the same organs, over the peribronchitis and ulcerations, over the broncho- and desquamative pneumonias and their products, over the processes of exudation and infiltration going on in the lungs, over the breaking-down of the infiltrations, over the formation of cavities and their contents, over phthisis and its symptoms, and finally over tuberculosis.

The sum of the indications before us is, then, tolerably comprehensive, and too many-sided to enable us to deal with all the individual problems set before us, even if we had fully recognised them.

As by the pneumatic method we are in a position to bring mechanical influence to bear directly upon the respiratory apparatus and the circulation, and can thus directly antagonise increase of functional and nutritive disturbances and pathological changes, we must refer a part of the task lying before us to the pneumatic method of treating pulmonary affections. (V. Part II.)

(a) *Prophylaxis.*

With a view to prophylaxis, precautionary measures will have to be taken by the physician, as follows:—

1. That where there exist hereditary tendency and predisposition to catarrhs of the respiratory tract and the apices of the lungs, or where simple catarrhal affections already exist, they may not develop into a chronic catarrh or the graver forms which usher in phthisis.

2. That individuals in whom there is no disposition and congenital tendency to tuberculosis may not acquire it in the way of contagion and succumb to florid forms running a more or less rapid course.



It is obvious that, as regards the first part of the task, prophylaxis must not be limited to the application of local agents, but that, according to our knowledge and experience, it must watch over the nutrition, education, and treatment of occasional illnesses, calling to its aid all dietetic and other sanitary measures which contribute to the strengthening of the individual, to his nutrition, sanguification, capacity of resistance, especially of the respiratory mucous membranes against the influences of temperature, and the expansion of the thorax and development of the lungs.

A principal part in the prophylactic task falls to the pneumatic method, which has to meet by mechanical means the conditions attached to the tuberculous habit, diminished expansibility of the thorax, slight expansion of the apices of the lungs, and insufficient apex-breathing, as well as also to some extent the other catarrhal affections.

The influence of medicinal substances is conditional upon the existence of one or other of the exciting conditions, a tendency to catarrhal or other inflammatory state of the respiratory tract and the lungs, as also the greater or less vulnerability and tendency to hæmorrhages from those parts. At the same time, however, all those precautions must be carefully observed which have been already recommended in the treatment of acute and subacute inflammatory and irritative conditions of the respiratory organs and especially of the lungs, in order that they may not be aggravated or the danger increased of their passing into chronic forms, and so leading to a habitual disposition, through the direct influence of one or other of the various medicinal agents, for the use of which there is not perhaps sufficient indication. This must be strongly insisted on in reference to the premature application of astringents, which are but too frequently used for inhalations in the erroneous expectation of cutting short acute inflammatory affections, especially catarrhs.

It is of the first importance to diminish the vulnerability and irritability of the respiratory mucous membranes, as well as to overcome the catarrhal tendency, either by the mechanical influence of changes of air pressure or by the chemical influence of medicinal agents. If hyperæmic conditions prevail,

together with irritability of the mucous membrane and tendency to catarrhs, inhalations of cold air, administered as long and as frequently as possible, must be tried, to reduce the irritability and sensitiveness of the mucous membrane and exercise an antihyperæmic and anticatarrhal influence.

Where, however, as occurs still more frequently, the respiratory mucous membrane, as far as it is visible, exhibits a pale and anæmic appearance; and the tendency to inflammatory affections is connected with its imperfect nutrition, we would recommend, of course together with appropriate general and dietetic measures, in the first instance inhalations of Ems water, weak solutions of Ems salt and common salt, to which small doses of tannin and alum may be added later on, if the inhalations set up no reaction. The inhalations themselves should be administered 2 to 3 times, at most 4 times a day, in sittings of 10 to 15 minutes at a time; by degrees the astringents may be raised to perhaps 2 or 3 per cent., and these stronger solutions may be continued, while the common salt ones may be somewhat diminished, but not laid aside altogether. If there is a tendency to hæmorrhage from the respiratory mucous membranes, strong solutions of tannin and alum must be used and administered without common salt for 3 to 4 or 6 weeks together. In such cases, especially in anæmia of the respiratory mucous membranes and general inanition, preparations of iron are indicated and are even preferable to the two other agents. Chloride of iron or tinct. ferr. pomat. may be used in such cases, and inhaled according to the urgency of the case either together with or after the introductory method given above. In anæmic conditions, especially at a later stage, when the irritability and vulnerability of the mucous membrane have been reduced, long-continued inhalations of tinct. ferr. pomat. or weak solutions of chloride of iron, subject to the general and dietetic treatment, are advisable. If considerable disturbances have been already set up in the respiratory tract and in the lungs, and if danger is at hand that the process, once begun, may extend and lead to further and yet further destruction of the pulmonary tissue and general infection, then the object must be to try with all the means at our command to arrest these processes and ward off the development of graver pathological forms as much as

possible, if they cannot be altogether cured. Although the greatest interest attaches to keeping the several processes in the development of phthisis as long as possible in certain stages and in retarding further destructive processes, if recovery is hopeless, yet all the more care must be taken that the phthisical patient should not become tuberculous.

Far as we yet are from even approximately meeting these demands, we must, so far as our insight into these diseases and the remedies at our command extends, grasp them in their whole extent on the basis of scientific investigation, and conduct the treatment in this sense.

2. The possibility that individuals in whom there was no predisposition or hereditary tendency to pulmonary phthisis or tuberculosis should yet acquire it by means of contagion and succumb to it sooner or later, had been repeatedly put forward by the older physicians, who had opportunities of making many observations, and in our days the possibility of a direct communication of tuberculosis by inhalations of pulverised sputa and their extraordinary infectious properties have been experimentally ascertained.

This being the case, the duty of the physician is to ward off in every way the well-known injurious influences by which this formidable disease is capable of diffusing itself wider and wider. The older physicians, who had large opportunities of observation, have repeatedly maintained, as Tappeiner has done recently, that quite healthy girls belonging to healthy families by long attendance upon phthisical patients have themselves become phthisical and died very soon, and they have thence deduced the theory that the contagious infection of phthisis was possible. I myself have made a number of remarkable observations on the subject, and have received from physicians who practised for many decades in the same neighbourhood communications which could only be satisfactorily explained by the hypothesis of direct transmission of tuberculosis to healthy subjects.

Tappeiner was the first to suggest the probability that phthisis might be transmitted by inhalation of the sputa of phthisical patients, scattered in fine particles through the air by coughing, and he made experiments on dogs with phthisical sputa in the Pathological Institute at Munich, which fully

confirmed the accuracy of his theory. Comparatively small quantities of phthisical sputa sufficed to produce phthisis and tuberculosis in various forms in perfectly healthy dogs. Tappeiner's experiments were frequently repeated in the Munich Pathological Institute, with the same result, and the deleterious nature of the sputa was fully proved. We may safely assume that the same sputa which, inhaled in a pulverised condition, are capable of generating tuberculosis in the lungs of dogs, so little disposed to tuberculosis, will have the effect of producing this disease in the incomparably more sensitive human lungs. There is also no doubt that by the elevated respiratory pressure of coughing the tuberculous sputa are pulverised in the same manner as by the compressed air of a Bergson's hydroconion, and the difference only lies temporarily in the small quantity which is reduced to pulverisation by each fit of coughing, but which is more than balanced by the frequency of the paroxysms and the duration of the malady.

In face of these facts the practical physician must put the question seriously to himself whether there are no means of preventing this transmission of tuberculosis to healthy persons by the respiratory air, and prophylactically resisting this disease as much as possible. I have myself been making experiments during the last two years for the solution of this question, and intend to carry them out systematically wherever there is reason to fear a direct transmission of such substances through inspiration.

There are several methods at our command by which we may effect an elimination of the sputa scattered through the air by coughing, in the sick room and in the vicinity of phthisical patients generally—first, by passing a free current of air through the rooms inhabited by such patients, by thorough ventilation and general cleanliness; secondly, by direct disinfection of the air in the vicinity of the patients; and thirdly, by attempting by inhalations of disinfectant and antiputrefactive agents, to which we shall return later on, to render the infective substances in the bronchi and the cavities of the patient himself more or less innocuous. We have learned practically by the application of Lister's spray in operations how completely the air can be cleared of the bacteria or septic germs contained

in it, and I would suggest that the same method should be adopted—the diffusion of the spray of carbolic, salicylic, or boracic acid in the immediate neighbourhood of the patient and in the sick room generally—for the purpose of precipitating from the air and destroying the sputa carried out by the expiratory current and scattered by the cough. When attending patients in advanced stages of phthisis, I have a 3 to 5 per cent. solution of carbolic or a 4 per cent. solution of boracic acid pulverised by means of a good inhalation-apparatus every hour for a quarter of an hour or longer, close to the sick bed or even in the immediate vicinity of the patient, and administer the same solution to the patient himself in inhalations four to six times a day. But even in the early and the middle stages of phthisis, when the patients are still able to move about, I administer disinfecting solutions several times a day, especially when there is profuse expectoration, partly to destroy the deleterious influence of the putrid and putrefying secretions of the bronchi and cavities upon the respiratory mucous membrane and the lungs (v. p. 332), partly to reduce their infective property as much as possible before their eventual suspension in the air, and to protect other persons from infection. For the same reason I make such patients wear medicated respirators with strong disinfectants in the receiver, for their own benefit and for the protection of other people. I also recommend the male and female attendants, at times when no thorough ventilation and disinfection of the air of the room by carbolic spray can be carried on, and when the patient has laid aside his respirator, to wear in the nose Feldbausch's small inhalation tubes, which are impregnated with carbolic acid.

I well know the difficulties that stand in the way of such a prophylactic treatment, as well as the objections that will always be raised against it. But necessity compels us, in dealing with a disease hitherto so inaccessible to prophylactic or therapeutic treatment, to adopt extraordinary measures and to carry them out with determination.

We now turn to the treatment of the affections themselves which are associated with pulmonary consumption, those with which it begins, and which in their further development lead to

actual phthisis, till, after a more or less chronic course, the whole process terminates with the appearance of actual tuberculosis.

(b) *Acute and Subacute Catarrhs.*

Frequent, seldom acute, generally subacute catarrhs of the larynx, trachea, and bronchi generally lead up to the pathological processes which afterwards develop, both in young people and in those of more advanced years, and are characterised not only by their recurrence, but by an abnormal irritability of the mucous membrane and by the resistance which they offer to treatment. After repeated relapses with symptoms constantly increasing in severity, they pass after a longer or shorter time into the chronic form.

In consequence of the great sensitiveness and vulnerability of the mucous membranes they require to be dealt with most cautiously; if local treatment is attempted, all irritant action must be excluded, as the very first condition. If these catarrhs are attended with hyperæmia, the most suitable treatment is the mechanical method in the pneumatic cabinet, while transportable apparatus, the application of which always excites distinct symptoms of irritation, are counter-indicated (v. Part II.) When it is not possible for the patient to be kept in the pneumatic chamber, inhalations of cold air must be employed, and continued till the inflammatory symptoms subside. When, on the other hand, the anæmic conditions prevail, and cold therefore cannot be well borne, inhalations of warm, emollient vapours should be administered several times in the day for ten to fifteen minutes at a time; also inhalations of the spray of distilled water, with the addition of 2 per cent. and subsequently 5 per cent. of glycerine, weak infusions of rad. althææ or thin emulsions of gum arabic or sweet almond oil, always exercise a most favourable influence; the internal administration of narcotics at the same time must not be neglected. At a later stage, when the first acute inflammatory symptoms have subsided, or the catarrh distinctly takes a more subacute course, inhalations of Ems water or solutions of common salt are well borne and frequently lead to a rapid subsidence of the still persisting symptoms.

As we refrain from the application of the transportable apparatus, so also must we carefully abstain from employing astringents, which are not tolerated even in dilute solutions or in the later stages of the malady, and generally only produce an exacerbation of the symptoms or complete return of the whole complex group of symptoms.

(c) *Apex Catarrhs.*

The treatment recommended for these catarrhs is also applicable to the catarrhal bronchitis of the apices of the lungs, the so-called apex catarrhs, if they run an acute or subacute course, only that the care bestowed on them must be even greater, owing to their very serious nature.

As these catarrhs very seldom come under treatment in the acute or subacute form, and as they have a marked tendency to pass rapidly into the chronic form, or to develop with the symptoms of this form, therefore the employment of the transportable apparatus, especially for inhalations of compressed air or alternate inspirations of compressed and expirations into rarefied air, must form a part of the treatment. This is the more necessary because the limitation of the space within which these catarrhs occur necessitates a mechanical dilatation of the space in order to arrest the rapid development of inflammatory processes and infiltrations. If it is possible to keep the patient in the pneumatic chamber, it may, with due regard to the inflammatory symptoms and the irritability of the bronchioles, be preferable to the employment of the portable apparatus. In combination with this mechanical treatment inhalations of cold air with retention of the breath, or, where there is scanty and difficult expectoration of viscid, vitreous, purulent mucus or obstinate dry cough, inhalations of Ems water or solutions of carbonate of soda, will have the effect of promoting expectoration and alleviating irritation, while in cases already running a chronic course with increased expectoration of viscid, muco-purulent secretion, inhalations of oleum pin. silv., oleum pin. pumil., together with vapours of decoct. althææ or weak aromatic infusions, are indicated by their action as alteratives and their influence in diminishing profuse expectoration.

In such cases also the application of astringents must be extremely limited. In chronic cases with profuse secretion weak solutions of alum or tannin may prove serviceable with the addition of common salt.

It is needless to say that besides the local catarrhal processes the fever and general symptoms must be attended to, and will demand careful treatment.

(d) *Chronic Bronchial Catarrh.*

If, after these symptoms have continued a longer or shorter time, the catarrh should cease to be localised, become widely diffused, and take the form of a chronic bronchial catarrh, frequently unattended with fever if there is no intercurrent acute exacerbation, while the peribronchial or pulmonary tissue itself does not yet participate in the inflammatory processes, the application of local agents and pneumatic treatment are indicated.

The symptoms which attend the course of these catarrhs are quite identical with those of ordinary catarrh, and generally involve the same indications; only we must always keep in view that the seat of these catarrhs, even when they run a feverless and torpid course, is always exceedingly vulnerable, and acute hyperæmia, with serous and cellular infiltration, are provoked by slight irritation. Therefore though the same general principles hold good as in the treatment of ordinary bronchial catarrh (v. supra), yet those remedies only must be employed which will excite no symptoms of irritation in the mucous membrane, and which, on the one hand, in cases free from fever with moderate cough and slight or no expectoration, excite a moderate secretion and relieve or entirely remove the cough, and on the other hand limit a too copious secretion and reduce more or less the swelling of the mucous membrane thickened by venous hyperæmia and stasis as well as by serous and cellular infiltration. In the first case weak solutions of common salt are most advisable, then solutions of sal ammoniac and carbonate of soda, to which, if necessary, narcotic preparations, such as aq. amygd. amar. or aq. laurocer., opium or morphine, may be added, especially where there is violent irritative and spasmodic cough. I have also repeatedly had occasion to



observe favourable results from extr. hyoseyam., extr. belladonnæ, and more especially extr. conii macul.

As regards the second class of indications, we would recommend, according to the gravity of the symptoms and the irritability of the mucous membranes, inhalations of oleum pin. silv. and pumil., ol. junip., ol. salviæ, alone or better combined with aqueous vapours and vapourised aromatic infusions, also of ol. terebinth., more rarely tar vapours very much diluted with water or the spray of rather weak solutions of tar water. As astringents alum and tannin in not too concentrated solutions may be used with advantage for inhalation; I generally combine them with common salt, or, if there is any tendency to decompositions, with tar water. In cases of decided anæmia, or in cases of capillary hæmorrhage, which is sometimes profuse and frequently the result of violent fits of coughing, when the vascular walls are ill nourished and easily ruptured, weak solutions of liqu. ferri sesquichlor. or of tinct. ferr. pom. may be administered, the iron in which may be to some extent absorbed and influence sanguification. One or other preparation of the other astringents may also be used if there is a special reason for it. But I have, as yet, seen no particular advantage from them or from nitrate of silver, while their application is sometimes attended with unpleasant secondary results.

Lastly, in these cases as well as in the treatment of the following grave forms of disease, the necessary general internal and dietetic treatment must be attended to.

(e) *Desquamative Pneumonia.*

Those cases which have advanced to the state of a chronic catarrhal or a desquamative pneumonia with considerable deposition of cellular inflammatory products, partly within air-cells, partly in the pulmonary tissue itself, are but slightly amenable to local treatment in the form of inhalations of chemical or pharmacological agents.

So long as the malady is generally attended with high fever, and the bronchial mucous membrane itself is actively involved in the inflammation, inhalations must not be thought of in the first instance, especially as we can exercise no influence

whatever by their means over the development and the course of these processes. It is not till the inflammatory symptoms have somewhat subsided, and the fever has abated, and the bronchial mucous membrane and the lungs are better able to bear direct treatment, that we may, according to circumstances, apply the direct influence of pneumatic or chemico-pharmacological agents.

As regards the indication for the former, we must refer to the special chapter on pneumatic treatment, and can only mention in this place that the greater part of what can be effected here therapeutically is due to the mechanical action of the transportable pneumatic apparatus and of the pneumatic cabinet. Medicinal agents in the form of vapours or liquids will have little influence on the course of the disease and the pathological changes which are set up by it. Here, again, it is more especially the implication of the bronchi in these pulmonary affections which specially demands inhalatory treatment and which we must always endeavour to limit or remove. The precautions which must be observed in the treatment of the bronchitis complicating such cases of chronic pneumonia are the same as those which apply to the treatment of bronchial catarrhs running a partly subacute, partly chronic course with prominent erethic character, only that there must be much greater caution and reserve in the application of topical agents.

Inhalations of weak solutions of alkaline salts, of Ems water, of dilute solutions of glycerine, of ethereal oils, together with emollient vapours, are especially called for. Only later on will it be safe to attempt to diminish secretion by weak solutions of alum or tannin with common salt, and they must be suspended so soon as they give rise to symptoms of irritation. Here as well as in the course of desquamative pneumonia itself the application of narcotics either by internal administration or in the form of inhalations is indispensably necessary, as the accompanying cough constantly excites the inflamed lung and the bronchial mucous membrane and keeps up the irritative conditions. Thus I have frequently found when the malady was at its height, with extensive inflammation of the lungs and pleuritic pains, which made all deep respiration impossible, inhalations of chloroform, stopping short of narcosis, adminis-

tered several times in the day, beneficial, and I have often employed them with advantage even when the bronchi were considerably implicated.

The infiltrations which are deposited in the air-cells and in the lung tissue by these chronic inflammations have been hitherto inaccessible to local treatment.

Attempts were made even at an early period (Laennec) to promote an absorption of these infiltrations by inhalations of iodine, either through the exhalations from Varec or by vaporisation of iodine and its solutions, tincture of iodine, iodic ether, or by smoking iodised cigars or by the spray of solutions of iodide of potassium and solutions of iodine in iodide of potassium. But often as these preparations have been experimented with, they have hitherto yielded only negative results, which for the present discourage further attempts in this direction.

Recently inhalations of nitrogen according to Treutler's process have been administered to remedy these pathological changes, and, so far as we can judge from the observations laid before us, valuable results have been obtained from them.

Chronic infiltrations of the apices of the lungs, of greater or less extent and intensity, disappeared gradually and even in a short time. The dulness diminished during inhalation at first with regard to its extent, and in several cases an encroachment of the boundaries of the sound lung tissue over the limits of the area of dulness could be distinctly traced; thus the dulness was narrowed on all sides (Kohlschütter). This was not, however, merely an extension of the healthy portions of the lung covering the dulness by vicarious emphysema, for a diminution of the intensity of the dulness was at the same time apparent; several times even the tympanitic clang of the percussion note, peculiar to infiltrations of the lung tissue in process of absorption, was found. At the same time, in those cases in which there had been absence of respiratory sound over the infiltrated spots, its return could be detected simultaneously with the clearing of the percussion note. This alteration in the physical signs at the apices of the lungs could only occur through the actual disappearance of the infiltrations either by way of absorption or of evacuation by the sputa.

In either case a softening and liquefaction of the infiltrations

was necessary, and this actually took place and was evidently followed by a removal of the softened masses by coughing as well as by absorption. As the area of dulness decreased crepitant râles took its place, or if they were previously present increased materially. The patients, who before had but little cough and expectoration or none, began simultaneously with the notable decrease of the infiltration to complain of both, and expectorated great quantities till the infiltration and dulness had disappeared.

These processes were always accompanied with more or less fever, which must be regarded as the fever of absorption, and the temperature rose on the average to 39° and sometimes to 40° C. Each inhalation was generally followed by an elevation of temperature of brief duration, which the next day gave place to the ordinary temperature, while lower and lower temperatures were observed during the subsequent period of the inhalations as compared with the commencement, till at last as the inhalations were continued the temperature remained altogether unaffected.

Night sweats generally accompanied the fever, often of great intensity, which shared with the elevation of temperature the peculiarity of gradually diminishing in intensity in the course of the treatment by continuous inhalations. With many patients, however, the fever which had been excited by the first inhalation persisted longer and assumed a continued form; at first moderate, it rose slowly, and after the inhalations were suspended it gradually assumed the type of a febris continua remittens descendens, while the general condition of the patient presented the aspect of a slight gastric fever. On examination of the patient during or after this time Kohlschütter found that the infiltration had entirely disappeared, and the lungs of two such patients have remained for now more than half a year completely normal.

In other cases, however—and these are the cases which, according to Kohlschütter, limit the value of nitrogen inhalations for the cure of phthisis—the fever persisted even after the suspension of the inhalations and passed directly into the well-known hectic fever of phthisis, with all the hectic symptoms, with evidently rapid liquefaction of the exudation, ulceration and

formation of cavities, wide-spreading infection and general tubercularisation. Even though we have no decisive proof that the nitrogen inhalations started the liquefaction and the ultimate development of phthisical and tuberculous processes, yet the steady rise of temperature, the infallible sign of absorption fever, points to this conclusion. So rapid a liquefaction of the infiltration necessarily leads to the rapid formation of cavities, the very same process as is set up in the last stage of chronic and at the outset of acute phthisis. Kohlschütter observed, however, that this softening and liquefaction of the infiltration, even when it led to the rapid formation of cavities, was not necessarily followed by hectic. In two cases the process ran its course without it, and he succeeded by suitable treatment and removal to a winter health-resort in warding off fresh ulceration and in procuring for a certain time at least a relative amount of health and capability of exertion for the patients.

Lastly, Kohlschütter was able to recognise, together with the reduction of the dulness, the disappearance of the infiltration at the apices of the lungs and the improvement of the general symptoms, an increase of the volume of the lungs and of their vital capacity, and an expansion of the walls of the chest.

Kohlschütter puts forward two hypotheses to explain the mode of action of nitrogen inhalations by means of Treutler's apparatus.

1. He lays emphasis on the necessity of making forced inspirations with this apparatus, to which patients are compelled partly by the various tubular combinations and movements of the cylinder, partly by the small amount of oxygen contained in the inspired air. He thinks it quite possible that by means of the combination of energetic and unconsciously excited deeper inspirations dilatation of previously collapsed pulmonary air cells partly filled with exudation may be brought about, and thus the absorption of the infiltration may be initiated. The expansion of the lungs which has been observed may also be taken as an evidence of this process. In this case the action would be purely mechanical, and would correspond to the action of the transportable pneumatic apparatus and the inspirations of rarefied air.

2. There is also a possibility that the alteration in the constituent parts of the air, which must lead to a highly nitrogenised residual air playing about the exudation and its cells during the inhalations and even for some time after, may bring altered conditions of existence to the cellular elements of the exudation, and possibly promote their fatty degeneration and liquefaction, and thus lead to absorption. He also calls attention to the possibility that the diffusion processes in the air of the lungs may be different when an atmosphere of so different a nature penetrates into them; but whether nitrogen as such plays a part in this, or whether it only acts as an innocuous agent for rarefying the atmospheric air, which might be replaced by other substances (hydrogen), is a question which remains unanswered for the present.

The inhalations of nitrogen were administered in the following manner:—The patients inhaled daily an average of about 120 litres from the apparatus—that is, 6 cylinders containing 20 litres each. Generally about 90 per cent. of nitrogen was added to the air in them, so that about 11 per cent. of the oxygen of the atmosphere was replaced by nitrogen. From time to time the quantity was increased or diminished: as a rule almost all patients tolerated an addition of nitrogen up to 96 per cent. of the inspiratory air; not, however, without the invariable occurrence of dyspnoea, which was at first an indication to Kohlschütter to suspend the addition of nitrogen, but afterwards, when he came to understand the action of this mixture of gases better, he was able to accommodate the dose to the object in view.

As to the duration of the experiments, Kohlschütter, so far as he has hitherto been able to observe the results of his attempts, does not prolong his inhalations beyond about four weeks at daily sittings of about half an hour each, resuming them, if necessary, after a pause of six weeks. The absorption of the infiltration, which proceeds very rapidly at first, declines gradually during the continuous administration of the inhalations, and not unfrequently a residuum remains behind, which may long resist every modification of the dose. But when the inhalations were again resumed after a somewhat long interval, they again showed the same energetic action, and the residue

of the dulness could then be made to disappear more completely, more rapidly, and more surely.

It is difficult as yet to express a decided opinion on the influence of nitrogen inhalations on chronic pulmonary infiltrations, as we have not nearly sufficient observations on the subject to exclude completely all the casualties which always occur in the treatment of pathological processes running so varied a course, and to be able to separate the influence of the various other agents which come into operation. For the present it behoves us to give a fair trial to nitrogen inhalations in the treatment of chronic pneumonia and its products, wherever this is possible, especially as we have hitherto been able to exercise very slight influence over these processes by general dietetic or by local treatment, or by climatic cures, while, on the other hand, the value of these inhalations has been repeatedly asserted by various authorities, such as Treutler, Steinbruck, Kohlschütter, and others.

(f) *Peribronchitis and Broncho-pneumonia.*

As in chronic pneumonia, so in the chronic inflammation of the peribronchial areolar tissue and the infiltrations and degenerations connected with it, but little result must be looked for from inhalations of pharmacological agents in the form of vapour or solution. We may, if we please, as was formerly done in cases of chronic pneumonia, prescribe inhalations of iodine and its preparations with the view of inducing absorption of the infiltration; but experience so far condemns all such fruitless efforts.

Mechanical treatment is the most hopeful in these diseases, by means of inhalation of compressed air, whether by the portable apparatus, or, better still, in the pneumatic cabinet, so that by the mechanical influence of pressure, we may diminish the hyperæmia and inflammation and hasten the absorption of the deposited exudations (cf. *infra*, *Pneumat. Therap.*)

Here again it is only the changes in the bronchial mucous membrane which are accessible to treatment by medicated inhalations, and their administration must be guided by the rules and precautions already laid down. The use of energetic

and irritating agents must be avoided here as in other cases as long as acute inflammatory processes can be detected, and the choice of remedies must be adapted to the indications present.

Lastly, in these cases as in chronic pneumonias and infiltrations of the lung tissue, we should consider the propriety of nitrogen inhalations according to Treutler's method. Kohlschütter found in some cases of old pleuritic exudations with adhesions, in which it was feared that a simultaneous infiltration of the parenchyma of the lung might occur beneath these deposits, that they diminished and disappeared under the use of nitrogen inhalations. There is therefore reason to suppose that the cellular infiltrations in the peribronchial tissue may by the influence of nitrogen inhalations suffer a retrograde metamorphosis and be absorbed. It will indeed always be difficult to bring forward direct evidence of these processes, should they really take place; still we might obtain grounds for supporting the favourable action of these inhalations in the course of the bronchial and pulmonary symptoms. For the rest the treatment of peribronchitis would generally be identical with that of chronic pneumonia, with which it is always complicated, and the nitrogen inhalations would then be able to act upon both processes.

What results we may ultimately obtain from them will soon be settled by time, which has already destroyed so many a beautiful dream.

(g) *Broncho-pneumonic Ulceration, True Phthisis.*

With the retrograde metamorphoses of the exudations and infiltrations in the peribronchial tissue, in the air-cells and in the pulmonary parenchyma, with their caseation, softening, and decay, actual phthisis begins with partial destruction of the lung tissue and formation of cavities.

The first object of treatment in this case would be to actually prevent the setting up of caseous changes in the exudations and infiltrations, and this was understood even at an early period. We have already repeatedly alluded to the attempts of various kinds to arrest or limit the destructive processes in the lung which lead to phthisis, hitherto without result. Among



these attempts was that of counteracting the caseous degeneration and the decay of the products of inflammation by changing the interpulmonary pressure by means of the pneumatic apparatus, as well as by inhalations of compressed and more especially by expirations into rarefied air, and the reasonableness of this method will always draw attention to it again in suitable cases.

We seem to possess in nitrogen inhalations, even though the attempts hitherto made with them await future confirmation, an agent for bringing the inflammatory products deposited in the lung tissue to liquefaction and absorption without destruction of the tissue, and this result would probably be secured except in a relatively small number of cases. We have already pointed out that nitrogen inhalations are not applicable to those cases where liquefaction of the infiltration and hectic fever have already set in, and a rapidly advancing decay is consequently to be feared. With this turn of things; however, other indications immediately present themselves. As destruction of the tissue is no longer to be averted, the objects of treatment must now be the symptoms attending the liquefaction, absorption, and destruction of the infiltrated portions of the lung, so far as they are accessible to the influence of our remedies. The most prominent of this important group of symptoms are—

1. The fever which is designated absorption fever. Kohl-schütter has observed constantly more or less high fever in the softening and absorption which were induced by nitrogen inhalations, and which in some cases persisted even after the suspension of the inhalations and passed directly into the familiar form of hectic fever. He attributes it, as already mentioned, to the absorption of the decomposed and liquefied masses of infiltration, and recommends physicians therefore not to force the cure, but to proceed with great caution as regards the time and duration of the inhalations, their repetition and the quantity of nitrogen. It cannot be decided beforehand whether the particular patient is able to tolerate the absorption and to eliminate the absorbed substances without grave disturbances of the whole organism. But here the indication becomes manifest for the application of antipyretic, antiseptic, and

disinfecting agents, and Kohlschütter accordingly suggested administering inhalations of medicinal substances which volatilise readily at a low boiling point, such as carbolic acid, thymol, oil of turpentine, either together with the nitrogen by means of the contrivance to be described under 'Pneumatic Apparatus' or after the sittings, while aqueous solutions of medicinal agents only applicable in the form of spray, such as salicylic acid or benzoate of soda, might also be directly applied by means of the spray producer. Hectic fever, which we may to some extent trace to the absorption of caseous and softened masses of the pulmonary tissue, also indicates, in addition to the ordinary internal treatment, steady application of antiseptics and disinfectants, and I have for many years, by keeping strictly to this method, obtained fairly encouraging results, if one may venture to use such an expression in treating of these processes. It is always a necessary condition of success that as large a quantity as possible of the remedies to be inhaled either in the form of fluid or vapour be conveyed into the lungs, partly to exert an arresting influence upon the processes of decomposition at work and to impregnate the softened caseous masses as much as possible with disinfecting substances, but partly also that these disinfectants should be directly conveyed thence into the blood current infected by the absorption of the disintegrated inflammatory products. I cannot but conclude that the anti-pyretic and antiseptic action of these remedies will be much more energetic when they are received into the blood at the same place with the septic bodies on which they are to act or in their vicinity, and when they are distributed over a smaller amount of blood, as that of the lesser circulation which is first infected, than if they only reach the general mass of blood from the stomach and the intestine by the portal system.

I use by preference in these cases inhalations of carbolic acid, benzoate of soda, which we shall treat of more fully when discussing tuberculosis, oil of turpentine, salicylic acid, thymol; and I administer the inhalations for weeks and even months together daily with the usual breaks, two hours at a time or longer. I also make considerable use of Curschmann's mask for inhalations of carbolic acid, creosote, thymol, and oil of turpentine, as it has the merit of allowing of long and continuous

inhalation without tiring the patient. During a long course of carbolic acid the urine excreted at different times in the day ought to be examined, and when it shows a deep olive-green colour the agent should be suspended for 1 or 2 days, and another, benzoate of soda being the best, substituted. At the same time we must not be in too great a hurry to leave off the carbolic inhalations at the first signs of a discoloration in the urine, for in this case also, as I have repeatedly observed, a prolonged impregnation of the blood with carbolic acid has a favourable effect (cf. *supra*, Diphtheria). I have never observed any injurious influences or intoxicating symptoms in consequence. Of course I need not say that neither can the process of caseous degeneration be arrested, nor phthisis very long kept back by this treatment; but if we can do anything against this frightful disease, and not leave the unfortunate phthisical sufferer entirely to his fate, this method is the most rational for these cases, and I have hitherto found it the most serviceable. The general and internal treatment will of course be directed most carefully according to the rules of special therapeutics.

2. If in the further development of the disease disintegration of tissue, ulceration, and formation of cavities should occur to a great extent, a series of symptoms will arise which unconditionally demand direct treatment. In the first place, we must not expect to be able to heal ulcerated surfaces when once formed, and where cicatrisation of such losses of substance has hitherto occurred we are as yet utterly ignorant of the conditions under which it happened, nor is it in our power to originate them. But we must always keep in view the fact that we have before us in these cavities portions of dead pulmonary tissue resting on foul, degenerating, ulcerated surfaces, with unhealthy secretions and offensive contents in an advanced state of decay; and, as a surgeon would certainly consider it inexcusable, if he had to do with such wounds and ulcers on the external parts of the body, if he did not keep them scrupulously clean and treat them antiseptically, so we must hold it to be more than blamable if we omit to do everything that is needful for the cleansing and disinfection of these cavities filled with decaying and putrid secretion,

with masses of not unfrequently foetid, ichorous substances covering their ulcerated surfaces and eroding the bronchial mucous membranes, rather than trust to the milk cure or to change of air, the value of which, however, in these cases I am far from underrating. I hold it to be absolutely necessary to be quite clear on this subject, and would therefore lay all possible emphasis on these points.

Our duty with regard to these processes is clearly marked out. As it is at present impossible to arrest the advancing decay of tissue and the suppuration in the cavities, or the breaking down of other caseous masses, or to counteract the further development of the co-existing lobular pneumonia, the treatment of these processes must be directed altogether on surgical principles, and a steady course of antiseptic and disinfecting treatment must be undertaken. The agents best adapted for this purpose are those mentioned above, whose vapours or pulverised aqueous solutions can best satisfy the claims made upon them. Thus 2 to 4 per cent. solutions of carbolic acid may be administered by inhalation 4 to 6 times a day for 8 to 12 minutes or longer at a time, according to the severity of the case, with attention to the precautions given above, or else 5 to 10 per cent. solutions of benzoate of soda may be substituted every 2 to 4 hours, in sittings of half an hour long, equally divided over the morning and evening; again, salicylic acid in 0.2 to 0.3 per cent. solutions, tar vapours, tar water, thymol, creosote water, oil of turpentine may be used in more concentrated solutions and in several sittings of  $\frac{1}{4}$  to  $\frac{1}{2}$  an hour long during the day. Inhalations of *ol. pin. silv.* and *pumil.*, *ol. juniper.*, *ol. salviæ*, with vapourised infusions of aromatic herbs in the form of emulsions, have a less effect. The peculiar power of these agents in limiting secretion and acting as disinfectants is also shared by vapours of Tolu, Peru, and copaiva balsams, which can also be employed as inhalations with aromatic vapours or in emulsions.

When there is distressing cough with little or no secretion carbolic acid must be avoided, and I administer in such cases, as also those with directly opposite symptoms, and with profuse secretion, benzoate of soda, employing 500 to 800 or 1,000 grammes of its 10 per cent. solutions through the day. Cursch-

mann's inhalation mask is very appropriate, especially for enfeebled patients who find the use of the ordinary inhalatory apparatus too fatiguing; by its means inhalations of vapours of carbolic acid, thymol, or creosote and oil of turpentine may be administered daily for several hours, repeated after longer or shorter pauses, during which the patient can remain comfortably in bed in the position which he finds easiest.

Under the local action of these remedies the sputum of the patients frequently changed in a few days, in character as well as in quantity. Generally only in the morning sittings, more rarely later on, the patients expectorated more or less profusely, but the expectoration always diminished in the course of treatment, till eventually it occurred only at this period of the day, and the patients during the rest of the day remained for hours at a time or almost altogether free from cough and expectoration. The quality of the sputa also improved with the diminution of the quantity, and from having been foetid, offensive, and beset with schistomycetes, became in a short time odourless, and the masses of *débris* and *fungi* either disappeared altogether or could only be detected singly. I have seen extensive and deeply seated laryngeal ulcers thickly covered with pus and contents of cavities, constricting the glottis and driven forwards with the expiratory current between the arytenoid cartilages, and drawn in again during inspiration, most completely cleansed and with a surface beautifully free from exudation, after inhalations of 500 to 1,000 grammes of a 10 to 5 per cent. solution of benzoate of soda within 24 hours, which I administered according to Rokitansky's directions. Also the thickly furred tongue and the larynx and pharynx, covered with the residue of the viscid muco-purulent expectoration, became gradually clean again, and the appetite, which had been entirely lost in consequence of the constant pappy, muco-purulent taste, returned, so that the patients gradually took more nourishment, and where the disease was not too far advanced, their general health improved remarkably. I often found that they had increased 10 to 15 lbs. in weight after 2 or 3 months. The fever also lessened, sometimes pretty rapidly, under the continuance of antiseptic treatment without any internal remedies, and the improvement thus obtained

persisted a considerable time, but fresh exacerbations ultimately led to a fatal termination. Since I began this strictly antiseptic treatment many of these patients have indeed succumbed to their malady; but the whole course of the disease and the subjective condition of the patients was far more favourable than under the usual merely expectant and dietetic treatment. Another series of patients who came under treatment at an earlier stage with only slight changes in the lungs, and who, after the exacerbations of their lung affection, subjected themselves again for weeks and months to antiseptic inhalations, show very favourable conditions of nutrition and a fairly satisfactory state of general health, while the phthisis advances remarkably slowly.

I rarely found it necessary to adopt any special treatment in dealing with the bronchial complications, and inhalations of the above-mentioned remedies, by disinfecting and diminishing the secretions, sufficed to check or arrest the catarrhal processes developing in the bronchial tubes. Such actual astringents as alum, tannin, sulphate of zinc, I have only used in isolated cases, and more for the sake of experiment, but without obtaining any particular advantage from them. Here the catarrh, apart from affections originating in the bronchi themselves, is frequently the secondary result of the destructive processes in the lung, and a chronic state of irritation is kept up on the surface of the mucous membrane of the air passages by the decomposing purulent contents of cavities which are constantly in contact with it or by which they have been covered for a long time. The improvement and retrogression of the bronchial catarrh kept pace with the improvement and decrease of these secretions. Special attention must be directed to the processes of decomposition going on within the cavities and the formation of corrosive secretions, through the action of which widely-spread erosive ulcerations, usually of a superficial kind, but still painful, may come to extend over the greater part of the laryngeal and tracheal mucous membrane. We are often able on dissection to follow (v. Ziemssen) such ulcerations from the larynx down along the walls of the trachea and the affected bronchus, which usually leads into a larger cavity, filled with ichorous contents, while at the same time the mucous membrane

of the bronchial ramifications opening into it, so far as the incompletely expectorated ichorous secretion flowed down, is seen more or less eroded. When the first trace of putrescent decompositions are observed in the sputa, as is generally the case where there is copious expectoration and evidence of large cavities in the lungs, it is imperative to attack this ichorous formation by the energetic use of disinfecting agents and by abundant inhalations of carbolic acid, or this alternately with benzoate of soda (500 to 1,000 grammes of 5 per cent. solution), to dilute the substances to be expectorated and irrigate the inflamed respiratory mucous membrane with disinfecting fluid. It is much easier thus to prevent the formation of erosive ulcers than to heal them when they are once produced, on account of the predominant tendency to constantly advancing destruction which characterises the ulcers of phthisical patients generally.

Under the influence of the breaking down of lung tissue hæmorrhage may occur at an early stage as well as in the more advanced course of phthisis, and will be more or less copious according to the calibre of the eroded vessel. The causes immediately at work here are rapidly disintegrating foci of softening of caseous lobular pneumonias or rapidly enlarging cavities, in which cases any bodily exertion, cold bathing, increase of the cough, straining at stool, or other processes by which cardiac action is accelerated, and the blood pressure in the lesser circulation suddenly raised, may be the immediate occasion of the hæmorrhage. It is not necessary that there should be large caseated deposits and pneumonic processes of long duration in order that these hæmorrhages may occur, for they will come on at the very onset when the pulmonary infiltrations are scarcely discoverable, as well as in the later or even in the last stage of phthisis; but whenever they occur in pulmonary consumption they will always be referrible to such lesions.

We have already discussed the treatment of these hæmorrhages when speaking of hæmorrhages that occur in the region of the respiratory organs generally, and may therefore refer to what has been there said. Antiseptic and disinfectant inhalations will neither ward off nor produce these hæmorrhages; they are not even induced by long-continued inhalations of benzoate of soda, such as Rokitansky recommends; at least I

never saw a case in which I could refer the hæmoptysis solely and wholly to any preceding active administration of these inhalations. I have made many observations on phthisical patients who suffered from frequently recurring hæmorrhages, and witnessed their occurrence before and during a long-continued course of antiseptic treatment, and even more frequently later on, after the inhalations had been laid aside for months. If hæmoptysis occurs during treatment with antiseptic and disinfectant inhalations, immediate measures must be taken to arrest the hæmorrhage by the inhalation of styptics, e.g. liq. ferr. sesquichlor., replaced later on by alum or by some other agent. If this object is gained, it will be advisable to proceed with the former inhalations for a long time, for consolidation of the thrombus and complete healing, till the patient has recovered from the hæmorrhage and the probable intercurrent disturbances attending it.

Inhalations of antiseptic and disinfectant agents are counter-indicated, as indeed is local treatment generally, in high fever, desquamative pneumonia, great prostration of the general strength, or when the patient reaches that stage of the malady in which even palliative results can no longer be counted on and death is close at hand.

(h) *Pneumomycosis.*

A constant symptom attending phthisis, but more marked in its later stages, is the development of great numbers of schistomycetes in the sputa of these patients; they are also found in post-mortem examinations in the contents of the bronchi and cavities, on the surface of the walls of the cavities, and on the bronchial mucous membrane itself, down to its finest ramifications and in the air cells (v. Ziemssen).

In a number of investigations undertaken for this special object I found in such cases that, in addition to various other forms of schistomycetes, one distinct kind was the most predominant, or it even occurred alone. In two cases of rapidly advancing florid phthisis and profuse expectoration the expectorated matter was thickly beset with numerous fungi of this kind, so that not even in the blood of animals suffering from anthrax could more bacteria or more stereotyped forms be



found. The accumulation of fungi increased with the advance of the disease, and on the very last day the forms, still preserving the same type, were present in great masses. Unfortunately, an autopsy was not permitted in these two cases, so that further pursuit of these observations was made impossible. The schistomycetes in these, as in most of the other cases, showed micrococci about 0.5 micr. mm. in size, arranged in rows of 4, seldom 6, in the torula form, like a string of pearls, but so that there was an evident separation of each couple, though the continuity still held, while the division of the secondary cells thus developed did not appear to be completely carried through. In this manner originated short delicate rods composed of single cocci, which without independent movement stood between the other elements; besides these forms, which were the most numerous, there were also other small rods consisting of two cocci, which had arisen from the division of the quadripartite ones, but always fewer in number; so that it must be inferred that the division of the single daughter-cells took place more rapidly than the final division. I have never in these cases observed micrococci in the form of colonies, nor any further putrefactive bacteria, and only in a few cases well-known bacillus forms, originating in the oral cavity, but always together with the epithelial cells and the other fungoid forms overlying them. The pus cells especially had absorbed the fungi in large masses, so that these preparations afforded one an opportunity of studying the remarkable behaviour of these young cells towards the fungi, to which I was the first to call attention. Otherwise the sputa showed no striking characteristics, except the quantity that was expectorated, and which resembled bronchorrhœic expectoration; neither did they exhibit any signs of putrid decomposition. In the cases of all these patients there was a persistence of high fever, rapid emaciation, failure of appetite, diarrhœa, and after for the most part a very short course of illness (4 to 6 months), before which time they appeared to be in perfect health, they sank with symptoms of most acute phthisis.

It is not my intention, in giving a detailed exposition of the results of these investigations, to pledge myself to Klebs's theory regarding the etiology of tuberculosis, although I have

no doubt that evidence will yet be brought forward which will amply justify it, but it seems to me highly important to direct general attention to these phenomena, so important as indications for treatment. Apart from any idea of specificity in these fungi, or any etiological connexion between them and the disease under consideration, we must regard these organisms as directly noxious when they develop in such masses during the course of a disease, and vegetate in a locality whence they can, through the ulcerated surfaces of the mucous membranes of the larynx, trachea, and bronchi, as well as by destruction of the lung-tissue and formation of cavities, not only themselves readily gain entrance to the blood and the tissues, but the products of decomposition resulting from their vegetative process can also be absorbed as easily as fluid substances. The time has at length gone by for treating these circumstances with indifference and allowing the most dangerous enemies to proliferate undisturbed in the organism.

It will not be very difficult to deal with these fungoid vegetations and their parasitic influences, provided they have not waxed too numerous and the patient's strength is not too much exhausted, since we possess remedies which, when administered in the form of inhalations, if they do not destroy them, at least arrest their vegetative process and in this manner make them innocuous. Their discharge from the lungs and the other air passages will be effected in a short time, so soon as their rapid multiplication is checked, by means of expectoration together with the aid of inhalations to facilitate it. Carbolic acid in 2 to 4 per cent. solutions, as also salicylic acid in 0.2 to 0.3 per cent. solutions, creosote water, tar water, inhaled in large quantities—200 to 300 grammes per diem—are fully sufficient for this purpose. Benzoate of soda, whose valuable antiparasitic action is indisputable, is also specially adapted for this purpose, as it may be inhaled in 5 per cent. solutions in large quantities (800 to 1,000 grammes daily) without injury; and, as I found by numerous trials, it promotes the discharge of the secretions from the bronchi and lessens their amount.

As this procedure coincides with the antiseptic and disinfectant treatment of advanced phthisis generally, we shall be thus in a position to ward off mycotic processes in the first

instance as they arise in the respiratory organs, and at the same time to destroy them when present.

In fact, since I have endeavoured to carry out this mode of treatment as much as possible with phthisical patients, I have no longer observed mycotic vegetations to the same extent in their sputa.

(i) *Tuberculosis.*

We have finally to include in the number of diseases amenable to inhalatory treatment tuberculosis, as the last link in the great chain of chronic pulmonary affections which are commonly grouped under the collective name of 'pulmonary phthisis.'

The pathological process attended with the formation of miliary nodules is now to be regarded as an infective disease, and to be separated from the other processes of phthisis, peribronchitis, and caseous lobular pneumonia; it generally winds up the series and, according to our experience so far, terminates invariably in death.

The efforts of therapeutics, numerous and varied as they have been for centuries since the very dawn of the science of healing, have been absolutely fruitless against the mighty, destructive power which this disease exerts over the several tissues and the vital processes of the organism attacked. Of late years the idea of seeking a specific remedy for this disease has been given up, and physicians have contented themselves with palliative measures in dealing with cases of phthisis and tuberculosis. A new impulse to investigation into the possibility of curing tuberculosis was given by the experimental evidence that this disease is communicable not only by inoculation with tuberculous matter, but also through inhalation of small quantities of phthisical sputa. These efforts were supported by the hypothesis, containing a great deal of probability (Klebs), that the process now characterised as infective was caused by vegetable organisms, as has already been most clearly proved in a series of other infective diseases. The first experiments in this direction were made by Schüller, who produced artificial tuberculosis and tuberculous inflammation of the joints in rabbits by causing them to inhale phthisical sputa, and who succeeded in subsequently removing and curing the disease by

inhalations of benzoate of soda, which were administered to the animals where it was possible in the proportion of one part for every one-thousandth part of their bodily weight every twenty-four hours. Following upon these researches, and suggested by them, came the therapeutic experiments of Rokitansky, who in a considerable number of cases of phthisis and tuberculosis, as well as in tuberculous pleuritis, administered in the same manner inhalations of a 5 per cent. solution of benzoate of soda to patients in the proportion of one-thousandth part of their bodily weight daily, therefore in the enormous quantities of perhaps 800 to 1,200 grammes of these solutions, according to their degree of concentration and the body weight of the patient, and after observation of these patients for several months came to the conclusion that tuberculosis was curable. Unfortunately, as is but too well known, these results were not confirmed by the experience of others or by his own later experiments—and the tuberculous patients died in spite of the inhalations of benzoate of soda.

It was not difficult to foresee the failure of Rokitansky's experiment. If we for the present admit the accuracy of Schüller's experiment, there is still an immense difference between the indications upon which success depended in the two experiments. In Schüller's it was a case of simple tuberculosis, the result of transmission, therefore a tuberculous formation, *κατ' ἐξοχήν*. The subjects of Rokitansky's experiments were phthisical patients whose lungs were already fundamentally changed by a series of destructive processes such as we have been considering—peribronchitis, caseous lobular pneumonia—which as yet have nothing to do with the vegetable organisms supposed to be at work in tuberculosis, and which may of themselves lead to a fatal termination, and which certainly cannot be cured by the antiparasitic action of benzoate of soda, even if it were possible to administer the necessary quantity by inhalation, which is disputed in various quarters.

But it is worth while to enquire where Rokitansky's mistake actually lay, and whether the very circumstance which led to this mistake may not have a therapeutic value, though not that attributed to it by Rokitansky. It is difficult to suppose that all the observations of the Innsbruck professor on febrile

conditions, on conditions of nutrition, on the course of the pulmonary affections, and even the determinations of weight, rested upon an error. I have tested Rokitansky's experiments in practice, the result of which I could easily foresee from having so long pursued an antiseptic and disinfecting method of treatment in cases of advanced phthisis, and carried them out strictly according to his directions in twenty-seven cases of phthisis. The result has already been virtually communicated in the preceding chapters. We actually do obtain by inhalations of considerable quantities of disinfecting fluid a by no means insignificant influence over the course of phthisical processes, though not to the extent of grappling with the original cause of the disease itself. The explanation of the favourable results which I have observed in several of these cases, and perhaps also of those in the cases communicated by Rokitansky, lies doubtless in the following circumstances :—

By inhalations of such large quantities of a powerful antiparasitic and antiseptic agent, especially in concentrated solutions, we not only obtain a far more thorough cleansing of the air passages, the bronchiectatic dilatations and cavities than has hitherto been effected, but mycotic processes and decomposition of the secretions are arrested by the increased expectoration accompanying the inhalations and by specific action of the remedy itself, and thus the absorption of poisonous substances is also checked. A favourable influence may also be exercised on the softening and decaying caseous foci, the development and metamorphosis of which can certainly not be prevented by benzoate of soda, by saturation with antiseptic fluid so far that a portion of the substances which become absorbed is thus made innocuous, and the medicine directly conveyed into the pulmonary circulation must act more effectually than when only internally administered. Besides, the patients are also compelled to swallow the large quantities of the fluid deposited in the oral cavity, so that in this way also a considerable amount of the benzoate of soda penetrates into the body. This may account for the diminution of fever, lowering of the temperature, and reduction of pulse-frequency. The thorough cleansing of the mouth and fauces by these inhalations removes the bad taste, and the patient's appetite is

generally improved; he can take more nourishment, and an increase of the body weight follows as a natural result. In consequence of the usually copious expectoration which accompanies, or immediately follows the inhalations, which, however, may diminish considerably later on from the often remarkable decrease of the sputa, the patients remain free from cough for hours together, their sleep becomes calmer and more continuous, and the general condition frequently experiences an unmistakable amelioration, where this is possible, under these combined influences.

If we give due weight to these circumstances, a favourable influence of inhalation of large quantities of benzoate of soda, such as Rokitansky suggested, is quite natural and explicable; only it is not a question of the specific influence of this salt on tuberculosis, but the effect must be attributed to entirely other circumstances; and secondly, this influence is not peculiar to benzoate of soda, but belongs to a whole series of medicinal bodies which have been employed for a long time in various quarters. We are just as powerless as ever to heal chronic pulmonary phthisis and tuberculosis by therapeutic methods or by internal and dietetic treatment, and what we gain is only an increase and improvement of these remedies, by which we can procure general palliative aid for the patient in the different stages of the disease and possibly defer the final result.

As we vainly attempt to combat tuberculosis, when once it has attacked the lungs, by means of any local treatment, so we must all the more actively face the preceding processes, as we are generally in a position to exercise a favourable influence upon them, and that the more hopefully the earlier we are able to take them in hand. This holds good of the local action of pharmacological remedies, as of mechanical treatment by the pneumatic apparatus, and indeed, as these form only a part of the treatment of phthisis, of the medicinal and dietetic procedure also. The earlier we can begin to treat not only the diseased parts, but also the organs which show a tendency to disease, so as to be able to influence the latter prophylactically, the more we shall be enabled to carry out a judicious system of attack, the mode of action of which is accurately known, according to the necessity of the affection before us.

Whether later on a remedy may be found which can directly subdue the cause of this disease, or whether we must continue by a combined treatment to resist the more threatening symptoms as they occur from time to time—and this so far has most probability on its side and at present determines our mode of treatment—must be left to the future.

For the present our appointed task is to weigh accurately the value of all existing remedies, and by using them rightly to remove so far as possible the conditions which favour the development of the disease, to restrict it in its diffusion, and to master it by combating its symptoms.

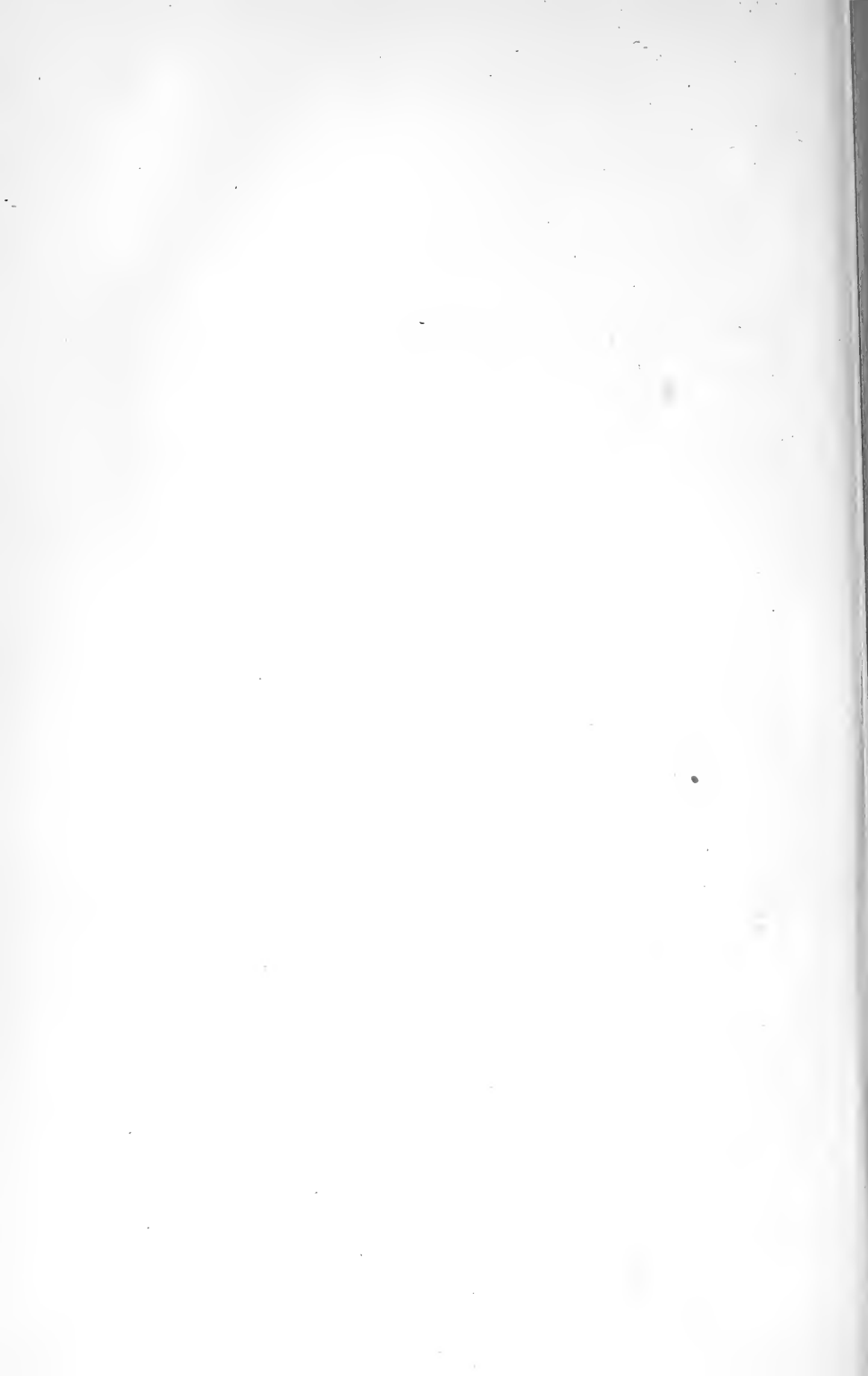



II.  
THE PHYSICAL PART  
OF  
RESPIRATORY THERAPEUTICS.

---

PNEUMATIC THERAPEUTICS.

*TREATMENT OF DISEASES OF THE RESPIRATORY AND CIRCULATORY ORGANS BY ALTERATIONS OF AIR PRESSURE.*

---

SECTION I.

ALTERATIONS OF ATMOSPHERIC PRESSURE ACTING ONLY ON THE PULMONARY SURFACE, SIMPLE AND COMBINED, BY MEANS OF THE PORTABLE APPARATUS.

---

A. METHOD REQUIRING THE CO-OPERATION OF THE PATIENT.

BIBLIOGRAPHY.

Ign. Hauke : 'An Apparatus for Artificial Respiration, and its Use in the Treatment of Disease.' Vienna 1870, pp. 29, 2 woodcuts. *Oesterr. Zeitschr. für prakt. Heilkunde*, xvi. 19, 20, 1870.—Id. : 'Treatment of Emphysema of the Lungs by means of Artificial Respiration,' *Transactions of the Society of Physicians at Vienna*; *Oesterr. Zeitschrift für praktische Heilkunde*, xvi. 33, 34, 1870.—Berkart: *The Lancet*, No. 25, 1871.—Horace Dobell: 'On a Residual Air Pump for Emphysema,' *Brit. Med. Journal*, Feb. 10, 1872.—Ign. Hauke: Appendix (to former treatise). Vienna, 1872. *Oesterr. Zeitschr. für prakt. Heilk.*, xviii. 37, 1872.—Mader: 'Communications of the Society of Physicians in Vienna,' *Oesterr. Zeitschr. für prakt. Heilkunde*, xviii. 37, 38, 1872.—J. Bradley: 'On the Employment of the Apparatus for Rarefying Air in Inflammations,' *The Clinic*, ii. Feb. 6, 1872.—Simonoff, Lewess, and others: *Transactions of the Medical Society at St. Petersburg*; *Petersburg Med. Record*, new series, iii. 3, 1872.—Ign. Hauke: 'On Improvement of his Apparatus for Artificial Respiration,' *Communications of the Society of Physicians at Vienna*, ii. 8, p. 90, 1873; *Wiener med. Wochenschr.*, xxii. 17, 1873; *Wiener med. Presse*, xiv. 19, p. 246, 1873.—L. Rohden: 'Emphysema of the Lungs and Hauke's Respiratory Apparatus,'

*Wiener med. Wochenschrift*, xxiii. 17, 18, 1873.—L. Waldenburg: 'A Portable Pneumatic Apparatus for the Mechanical Treatment of Respiratory Diseases,' *Berl. klin. Wochenschr.*, x. 39, 40, 1873.—Id.: 'On the Mechanical Action of the Portable Pneumatic Apparatus on the Heart and the Circulation of the Blood,' *ib.* xi. 4, p. 41, 1874.—Id.: 'Some Remarks on the Portable Pneumatic Apparatus,' *ib.* 4, p. 44, 1874.—V. Cube: 'The Double Pneumatic Apparatus and its Combined Action in the Mechanical Treatment of Diseases of the Respiratory Organs,' *Wien. med. Wochenschr.*, xxiv. 28, 29, 1874.—K. Störk: 'On a New Respiratory Apparatus,' *Wiener med. Wochenschr.*, xxiv. 5, 20, 24, 39, 40, 1874.—B. Fränkel: 'Demonstration of a Pneumatic Apparatus' (Berl. med. Gesellsch.), *Berlin. klin. Wochenschrift*, xi. 14, p. 169, 1874.—Id.: 'A Simple Pneumatic Apparatus,' *Centralb. für die med. Wissenschaft*, 44, 1874.—Joh. Schnitzler, Description of his Apparatus, *Wiener med. Presse*, xv. 14, 15, 1874.—Id.: 'On the Therapeutic Application of Condensed and Rarefied Air,' *Wiener med. Presse*, xv. 10 et seq. 1874; *Communications of the Society of Physicians at Vienna*, iii. 5, 1874.—Andr. Högyes: 'Brief Communication on the Bunsen Water-Engine Bellows as Artificial Respiratory Apparatus for Compensating Respiratory Insufficiencies,' *Centralb. für d. med. Wissensch.*, xii. 11, 1874; *Pester med. Presse*, x. 12, 1874.—L. Geyer: 'On Substantive Emphysema of the Lungs,' inaugural dissert., Jena, 1874, 8, pp. 20, with one drawing of a double apparatus.—J. Sommerbrodt: 'On the Treatment of Bronchial Catarrh with Compressed Air,' *Berl. klin. Wochenschr.*, xi. 20, 25, 1874.—Id.: 'On Waldenburg's Pneumatic Apparatus,' *ibid.* 31, 1874.—Ph. Biedert: 'Cheap Pneumatic Apparatus with Equal Action and Unlimited Duration of Action,' *Berl. klin. Wochenschr.*, xi. 29, 1874.—Trentler: 'Simplified Pneumatic Apparatus,' *Wien. med. Wochenschr.*, xxiv. 33, 1874.—Dührssen: 'On the Mechanical Action of the Portable Pneumatic Apparatus,' *Deut. Klinik*, 16, 1874.—Haenisch: 'On the Efficacy of the Pneumatic Method of Treatment,' *Deutsches Archiv für klin. Med.*, vol. xiv. 5 and 6, p. 445, 1874.—G. Lange: 'The Pneumatic Cabinet and the Portable Pneumatic Apparatus,' *Allgem. med. Centralzeitung*, 28 et seq., 1874.—Saanes: *Treatment of Pulmonary Diseases with Compressed or Rarefied Air by means of Waldenburg's Pneumatic Apparatus*. Rotterdam, 1874.—Tobold: 'On Lung Gymnastics,' *Deutsche Klinik*, 11, 1875.—B. Fränkel: 'A Cheap Pneumatic Apparatus,' *Berlin. klin. Wochenschr.*, xii. 19, 1875.—J. Schnitzler: 'Pneumatic Treatment of Pulmonary and Cardiac Affections,' *Wiener Klinik*, 1st annual course, No. 6, June 1875. Vienna, Urban and Schwarzenberg, pp. 31.—Weil: 'On a Modification of Waldenburg's Portable Apparatus,' *Allgem. med. Centralzeitung*, xlv. 19, 1875.—K. Störk: *Communications on Bronchial Asthma and Mechanical Pulmonary Treatment*, with an Appendix on 'Irritative Cough.' Stuttgart, 1875, F. Enke, 8, p. 102.—V. Cube: *Berlin. klin. Wochenschr.*, xii. 12, 1875.—Domanski: 'On Local Treatment of Diseases of the Respiratory Organs,' *Berl. klin. Wochenschr.*, xii. 1, 1875.—Drosdoff and Botschetschkaroff: 'The Physiological Action of Compressed Air in Waldenburg's Apparatus on the Arterial Blood-pressure of Animals,' preliminary communication, *Centralb. f. die med.*

*Wissensch.*, 1875, xiii. 5.—K. Störk: 'Séance of the Society of Physicians at Vienna,' Jan. 22, 1875, *Med.-chirurg. Rundschau*, 1875, 2 passim.—L. Waldenburg: *Pneumatic Treatment of Affections of the Respiration and Circulation in Connection with Pneumatometry, Spirometry, and Thoracic Measurement*, with 30 woodcuts. Berlin, 1875, Hirschwald.—Schivardi: *Pneumatic Treatment and Dr. Waldenburg's Apparatus: Note*. Milan, 1875, 12, p. 8.—Drosdoff: 'On the Influence of the Inhalation of Condensed and Rarefied Air,' *Centralb. für die med. Wissensch.*, 1875, xiii. 45, 46.—H. Dobell: *On Winter Cough, Catarrh, Bronchitis, Emphysema, Asthma*. London, 1875, p. 169 et seq.—Ph. Biedert: 'Communication on the Pneumatic Rotatory Apparatus,' *Berl. klin. Wochenschr.*, xii. 50, 51, 1875.—Sieffermann: 'Some Observations on Pneumatic Treatment,' *Gaz. méd. de Strasbourg*, Sept. 1, 1875.—Id.: 'Climatology and Aerotherapeutics,' *ibid.* Oct. 1, 1875, p. 10.—Haenisch: *Deutsche Klinik*, 13, 1875.—A. Adler: 'Pneumatic Treatment of Pulmonary and Cardiac Affections,' *Pester med.-chir. Presse*, xi. 46, 47, 1875.—Ducrocq: *Recherches expérimentales sur l'Action physiologique de la Respiration d'Air comprimé*. Paris, 1875, Adrien Delahaye, 53, &c., 15 plates.—Knauthe: 'Reports on Pneumatic Therapeutics and the Transportable Pneumatic Apparatus,' *Schmidt's med. Jahrbücher*, 1875, vols. clxv. clxvii. clxviii.—Ph. Biedert: 'Communications on the Pneumatic Method,' *Deutsch. Archiv für klin. Med.*, 1876, xvii. p. 164.—J. Schnitzler: 'A New Continuously Acting Respiratory Apparatus,' *Wiener med. Presse*, 1876.—Knauthe: *Handbook of Pneumatic Therapeutics*. Leipzig, 1876. O. Wigand.—Sommerbrodt: *A New Sphygmograph and New Observations on the Pulse Curves of the Radial Arteries*. Breslau, 1876.—Id.: 'The Influence of the Inspiration of Condensed Air on Heart and Vessels,' *Deutsch. Archiv f. klin. Med.*, vol. xviii. 1876.—Ph. Biedert: 'The Pneumatic Method and the Transportable Pneumatic Apparatus,' *Volkmann's Collection of Clinical Lectures*, No. 104, 1876.—G. Lange: 'The Transportable Pneumatic Apparatus and the Pneumatic Cabinet,' *Deutsche med. Wochenschr.*, 12, 13, 1876.—Id.: 'Transportable Pneumatic Apparatus,' *ibid.* 24, 1876.—Riegel and Frank: 'On the Influence of Compressed and Rarefied Air on the Pulse,' *Deutsches Archiv für klin. Med.*, vol. xvii. 1876.—Geigel and A. Mayer: 'Brief Communication on a Continuously Acting Transportable Pneumatic Apparatus on a New Mechanical Principle,' *Deutsche med. Wochenschr.*, 22, 1876.—Id.: 'The Water Engine Ventilator, a Continuously Acting Transportable Pneumatic Apparatus,' *Deutsch. Archiv für klin. Med.*, vol. xviii. 1876.—Blumberg: 'On the Use of Compressed and Rarefied Air,' *Philadelph. Med. and Surg. Reporter*, Sept. 1876.—Clar: *Communications on Gleichenberg*. Graz, 1876.—V. Basch: *Volumetric Measurement of Blood Pressure in Human Beings*. Vienna, 1876.—Casorati: 'Sulla Cura Pneumatica nelle Malattie Pulmonari e Cordiache,' *Lo Sperimentale*, 6, 8, 1876.—Sieffermann: *Aléothérapie et Pneumatothérapie*. Strassburg, R. Schultze & Co., 1876.—A. Küss: *Etude sur la Pneumatométrie et la Pneumothérapie*. Strassburg, Typographie Sielbermann & Co., 1876.—Langenhagen: 'Observation d'un Cas de Tuberculose enrayée par la méthode et l'appareil aérothérapiques du Dr. Waldenburg,' *Revue d'Hydrologie méd.*, 6, 1876.—Giuliani:

*Apparecchio respiratorio a semplice ed a doppio effetto ed a livello costante.* Napoli, 1876.—Closset: 'Lecture on Pneumatic Therapeutics,' *Correspondenzblatt der ärztlichen Vereine der Rheinlande, Westphalen u. Lothringen*, April, No. 17, 1876.—Geigel and Mayer: *The Water-Engine Bellows applied to Pneumatic Therapeutics: Monograph.* Leipzig, published by Vogel, 1877.—V. Basch: 'On the Influence of the Inhalation of Compressed and Rarefied Air on the Blood Pressure of the Human Being,' *Wiener med. Jahrbücher*, 1877.—A. Küss: 'Le Traitement Mécanique des Affections de la Poitrine et du Cœur,' *Gaz. hebdomad.*, 48 seq. 1877.—Szohner: 'On the Initial Stage of Pulmonary Consumption and its Treatment by the Pneumatic Method,' *Pester med.-chirurg. Presse*, 3, 4, 1877.—Fontaine: *Effets Physiologiques et Applications Thérapeutiques de l'Air Comprimé.* Paris, 1877.—Lambert: *Etude Clinique et Expérimentale sur l'Action de l'Air Comprimé et Rarefié dans les Maladies des Poumons et du Cœur.* Paris, Baillière, 1877.—Bernheim: *Leçons de Clinique Médicale.* Paris, Baillière, 1877.—Thaon: 'Traitement Pneumatique de la Phthisie,' *Progrès méd.*, 35, 1877.—Massei: *Caso di Asma guarito col Trattamento Pneumatico.* Napoli, 1877.—Davis: 'The Respiration of Compressed and Rarefied Air in Pulmonary Diseases,' *Chicago Med. Journal and Examiner*, Oct. 1877.—Rosenfeld: 'On Pneumato-Therapeutics,' *Württemberg medic. Correspondenzbl.*, 33, 1877.—Brügelmann: *Inhalationstherapie*, 2nd edition, 1877.—Coën: *Respiratory Apparatus for Stammerers.* Vienna, 1877.—Lorenz: 'Aërotherapeutics by means of Transportable Pneumatic Apparatus,' *Münchener Aerztl. Int.-Blatt*, 38, 1877.—Kowalewsky: 'On the Effects of Artificial Respiration on the Pressure in the Aortic System,' *Arch. f. Anat. und Physiol.* (Physiol. Section), iv. and v. p. 416, 1877.—Fenoglio: *Intorno all' Influenza dell' Aria Rarefatta o Compressa Attenuta d' all' Apparecchio di Waldenburg nelle Malattie del Cuore.* Turin, 1877.—Id.: 'On the Pneumatic Therapeutics of Cardiac Diseases,' *Centralbl. für die med. Wissensch.*, 46, 1877.—Berkart: *On Asthma: its Pathology and Treatment.* London, 1878.—J. Lehmann: 'Report of the Medico-Pneumatic Institution, from April 1, 1877, to March 31, 1878,' *Hospitals-Tidende*, 2nd series, vi. 15, 1879.—Burreli: 'On the Treatment of Pleuritis,' *Lo Sperimentale*, xli., and *Centralbl. f. d. med. Wissensch.*, xvi. 23, 1878.—Szohner: 'On the Efficacy of the Pneumatic Mode of Treatment,' *Pester med.-chirurg. Presse*, 7, 1878.—Schreiber: 'On the Influence of Respiration on Blood Pressure from a Physiological and Pathological Point of View,' *Arch. f. experim. Pathologie*, vol. xi. 1878.—Zuntz: 'Contributions to the Knowledge of the Effects of Respiration on the Circulation.' Bonn, 1878. Sep. printed from *Pflüger's Archiv*, vol. xvii.—G. Lange: 'Communications on the Action of the Transportable Pneumatic Apparatus,' *Schweizer Correspond.-Bl.*, viii. 4, 1878.—Guttman: 'A Case of Aggravated Bronchial Asthma treated according to Schnitzler's Method,' *Wiener med. Presse*, xix. 24, 1878.—Waldenburg: *La Medicina Pneumatica e gli Apparecchi della Stessa: con Note di Plinio Schivardi.* Milan, 1878.—H. Schnyder: 'The Transportable Pneumatic Apparatus and Lung Gymnastics by the Stick Exercise (Stockturnen),' *Schweizer Correspond.-Bl.*, viii. 22, 1878.—Geipel: 'Employment of

Fränkel's Pneumatic Apparatus in the Resuscitation of a Child apparently Dead by Drowning,' *Berliner klin. Wochenschr.*, 6, 1878.—Forlanini: 'Le Espinazioni nell' Aria Compressa cogli Apparati Pneumatici Transportabili,' *Archivio per le Scienze Mediche*, vol. iii. Turin, 1879.—Mosso: 'Diagnostics of the Pulse with regard to its Local Changes.' Leipzig, 1879, Veit.—J. C. Holm: 'On Pneumatic Treatment,' *Norsk Mag.*, 3rd series, ix. 3, p. 230, 1879.—P. Burreli: 'Pulmonary Emphysema and Failure of Heart Action cured by Aërotherapeutics,' *Lo Sperimentale*, xliii. p. 500, May 1879.—Kelemen: 'On the Question of the Indications for Compressed and Rarefied Air,' *Pester med.-chir. Presse*, xv. 1879.—Pramberger: 'On Aërotherapeutics,' Address delivered to the Medical Society of Styria, *Wiener med. Presse*, xx. 49, 50, 51, 1879.—Edlund: 'On Waldenburg's Transportable Pneumatic Apparatus,' *Hygiea*, xli. 5, p. 295, May 1879.—Mordhorst: 'On the Blood Pressure in the Aortic System and the Distribution of the Blood in the Pulmonary Circulation during Inspiration and Expiration,' *Archiv f. Anatomie und Physiologie*, 1879.—Löwitt: 'The Influence of Respiration on the Human Pulse,' *Arch. f. experim. Pathologie*, vol. x. 1879.—Kelemen: 'Contribution to the Theory of Pneumatotherapeutics, on the Diuretic Secondary Action of Compressed Air in the Treatment of Purulent Pleuritic Exudation,' *Pester med.-chir. Presse*, 1879.—Cron: 'Contribution to Pneumatic Therapeutics,' *Berl. klin. Wochenschr.*, 39 seq. 1879.—Raffaele Amati: *L' Apparecchio del Waldenburg quale mezzo terapeutico*. Bologna, 1879.—L. Waldenburg: *Pneumatic Treatment of Diseases of the Respiration and Circulation*, &c., 2nd enlarged edition, with an Appendix on the Climate of Elevated Regions, with woodcuts. Berlin, Hirschwald, 1880.—Id.: *Measurement of the Pulse and of Blood Pressure in Man*. Berlin, 1880, A. Hirschwald, pp. 141-147.—W. Brügelmann: *Inhalatory Treatment*. Cologne and Leipzig, 1880.—Sophia, Marquise A. Ciccolini: *Deep Inspiration: its Method of Application for the Promotion of the Art of Singing, as well as for the Cure of Various Diseases, especially Consumption*. Dresden, 1880, 2, Pierson.—P. Niemeyer: *Aerztliche Sprechstunden*, 2nd vol. Jena, H. Costenoble.—Knoll: *On the Influence of Modified Respiratory Movements on the Human Pulse*, with several woodcuts and 2 lithographic appendices. Prague, Tempsky, 1880.—Roszbach: *Manual of Physical Methods of Treatment*. Berlin, Hirschwald, 1881.—Speck: *The Pneumatic Method of Treatment; or the Application of Compressed and Rarefied Air in Pulmonary Diseases*. Dillenburg, Seel, 1881.

## INTRODUCTION.

THERE are a series of diseases of the respiratory organs, and especially of the lungs, in the treatment of which we may, by exercising a mechanical influence in the form of pressure or suction on their surface, induce changes which affect the existing pathological processes and the tissues in a most definite manner.

As the air presses on the surface of the respiratory organs with the continuous pressure of one atmosphere, we shall find increasing or diminishing that pressure the most convenient way of exercising such a mechanical influence. This method also affords us the means of carrying out a mechanical treatment of these as well as of other organs topographically and functionally connected with them, and of determining from the outset the effect to be produced upon the tissues with respect to form, density, resisting power, and elasticity; so again the amount of displaceable fluid in them is subjected to increased or diminished pressure to a determined amount, and thus the capacity of the whole respiratory tract can be made to suffer considerable changes.

We bring increased pressure to bear on the surface of the respiratory organs when, by compression, we increase the density of the air inspired, so that it exercises a pressure greater than that of one atmosphere, or when during expiration we introduce a resistance which is greater than the pressure of one atmosphere and which the expiratory pressure has in expiration to overcome—that is to say, when we make the patient either inspire compressed air or expire into compressed air. We obtain a diminution of atmospheric pressure (an action analogous to that of cupping glasses) when we rarefy the air contained in the respiratory organs either by causing the patient to expire into rarefied air or to inspire rarefied air, and either way the air in the lungs will be submitted to a lower pressure than that of the atmosphere.

These four modifications of air pressure—viz.

1. Inspiration of compressed air,
2. Expiration into compressed air,
3. Inspiration of rarefied air,
4. Expiration into rarefied air—

may be easily and accurately applied, and a mechanical treatment of these organs thus made possible by suitably constructed apparatus, which, on account of their portability, are called *transportable pneumatic apparatus*. Of these modifications of variations of air pressure only two, the inspiration of compressed air and expiration into rarefied air, which alone were contemplated by the discoverer, have come into general use; the other modifications were suggested by Waldenburg and only partially adopted even by himself. It is also possible, by combining these four methods, to bring abnormal pressure relations to bear on inspiration and expiration at the same time for therapeutic or scientific purposes. Of the modifications thus rendered possible only one—inspiration of compressed air and expiration into rarefied air—has been hitherto made use of therapeutically to any extent, while the other modifications—viz. the inspiration of compressed and expiration into compressed air, the inspiration of rarefied and expiration into condensed air, and the inspiration of rarefied and expiration into rarefied air—have not been thoroughly investigated, and have only been studied carefully by Speck in their relation to respiration and the interchange of gases.

The importance of the inspiration of compressed and expiration into rarefied air was first maintained by Cube, who made it a special consideration in the construction of his double apparatus. The most complete application and utilisation of the changes of air pressure possible by this combination has recently been provided by the water bellows (*Schöpfradgebüse*) of Geigel and Mayer with the double ventilator, which must now be regarded as the most perfect transportable pneumatic apparatus. Waldenburg had already, when the necessity arose, combined the inspiration of compressed air with expiration into rarefied air in either of two ways—either by making a certain number of expirations follow a series of inspirations by means of his simple apparatus, or by combining two of the gasometer apparatus so as to cause an expiration into rarefied air to follow immediately upon an inspiration of compressed air. This method has been generally termed the combined method, and the first modification has been described as the intermitting, the second as the alternating method.

Since in this case the pressure or suction acts on the pulmonary surface only (*einseitig*), and does not at the same time act on the general surface of the whole body (*allseitig*), as is the case during residence in an atmosphere of compressed or rarefied air, as in the diving-bell, or on heights, or in the pneumatic chamber, therefore we must always employ only a relatively feeble force, to avoid a distension of the lung tissue by positive pressure on the one hand, or the risk of vascular rupture and hæmorrhage by too great rarefaction of the air on the other. The degrees of pressure possible with the transportable apparatus vary between a  $\pm$  pressure of  $\frac{1}{30}$  to  $\frac{1}{40}$  atmosphere only; and even between these limits the higher degrees of pressure of compressed as well as of rarefied air is only employed therapeutically in exceptional cases, and generally we use only the medium degrees of pressure up to  $\frac{1}{40}$  atmosphere with compressed and  $\frac{1}{30}$  atmosphere with rarefied air. Of the degrees of pressure possible with the different apparatus, we shall speak more fully when we come to the description of these apparatus, and of the special estimation of the degree of pressure applicable in individual diseases, in the therapeutic section.

Alterations of air pressure, limited to the pulmonary surface, by means of the portable apparatus act purely mechanically either by pressure or by suction, and not only upon the respiratory organs and their functions, but also upon the lesser circulation by the displacement or suction to which the blood circulating in the pulmonary circulation is subjected, and through this finally upon the heart and the systemic circulation.

This mechanical effect is exercised during both parts of the respiratory act, upon inspiration as well as upon expiration.

In the use of the transportable apparatus whatever chemical influence is exerted upon the functions of respiration is solely a result of the mechanical agency. While by the inspiration of compressed air portions of the lung which have previously been inactive become restored to activity, on the other hand by forcible expiration into rarefied air, in pulmonary affections with insufficient expiratory power, the inspiration which immediately follows becomes deeper and fuller, and the respiratory changes necessary to nutrition are accelerated, though no



special influence is exerted upon the systemic processes of oxidation, nor is there any absolute increase of absorption of oxygen (cf. Pneumatic Cabinet).

Finally, an attempt has been made to associate with the mechanical treatment a simultaneous chemical action upon the mucous membranes of the respiratory organs and the pulmonary surface itself, by mixing volatile medicinal agents and respirable gases with the compressed air. For this purpose contrivances are affixed to the different pneumatic apparatus which facilitate this medication. We shall return to this subject further on.

---

### APPARATUS.

The number of the so-called transportable apparatus now at our command for the mechanical treatment of the respiratory and circulating organs is already considerable. They differ not only as to the principles upon which they are constructed, but also in the extent of their applicability.

The first apparatus of Hauke and Störk are boiler apparatus with water outlet, compression and rarefaction of the air being produced by bellows or water pressure. The apparatus more recently introduced and most generally employed are constructed on the principle of the gasometer or that of the bellows and the accordion, while Geigel's new apparatus makes use of the water-engine bellows very much employed formerly; and various other mechanical motive powers besides these have been employed in the construction of such apparatus, as Bunsen's water-engine bellows by Högyes, then Finker's modification of B. Fränkel's suction pump, but none of these have come into practical use. Almost all the apparatus, with the exception of that constructed by Berkart and H. Dobell, which only admits of expiration into rarefied air, as also inspiration of the same, and is now very seldom used, admit of the employment both of compressed and of rarefied air, either separately and intermittingly or (at least the best of them) combined into double apparatus, and in alternation (the apparatus of J. Hauke, L. Waldenburg, Schnitzler, Tobold, Störk, Biedert, Fränkel, Treutler, J. Lange, Geigel and Mayer). The double

apparatus of Cube, Weil, Schnitzler act continuously with the application of compressed and rarefied air, or intermittently and alternately with interruptions for the emptying and filling, as the simple apparatus combined into two apparatus. The apparatus recently invented by Finkler and Kochs enables the patient to inspire compressed and expire into rarefied air at the same time. Geigel and Mayer's double ventilator provides a constant continuous action of each method.

It would carry us too far to enter into a full critical description of these several apparatus, and we must therefore content ourselves with describing somewhat minutely the apparatus which are really serviceable for scientific researches and practical purposes, according to their construction and technical manipulation, comparing their efficiency so far as it is necessary.

#### (A) BOILER APPARATUS.

##### 1. *Hauke's Apparatus.*

Although other physicians had previously cherished the idea or made attempts on their own account to administer inhalations of compressed air for therapeutic purposes, yet the honour belongs to Hauke not only of having rightly grasped the value of the mechanical action of condensed and rarefied air, but also of having realised this idea by the publication of his experiments, together with the design of a transportable pneumatic apparatus constructed by himself.

Unfortunately he did not succeed in producing an apparatus which admitted of a sufficient development of force and constancy, and even the various improvements which he made in his original apparatus failed to correct its inherent defects, as the principle itself on which the apparatus is constructed is an erroneous one, and improvements in its technical execution could not do away with the deficiencies resulting from this radical error. His apparatus, therefore, was but little used, and is now completely superseded by far better ones which answer all the purposes of scientific experiment and practical application. The apparatus itself has now only an historical value.

In its later improved form Hauke's apparatus (fig. 18) consists of a cylindrical leaden vessel 26 centimetres high and 29

centimetres in transverse diameter, which is divided by a partition not quite reaching to the bottom into two equal portions, which communicate below. One of these divisions is open above; the other, the actual air-receiver, is closed at the top and is prolonged 12 centimetres higher; it has two tubes (*a* and *b*) passed through its cover, both of which lead into the air-receiver, and serve to receive tubes, one of which *c* communicates with the

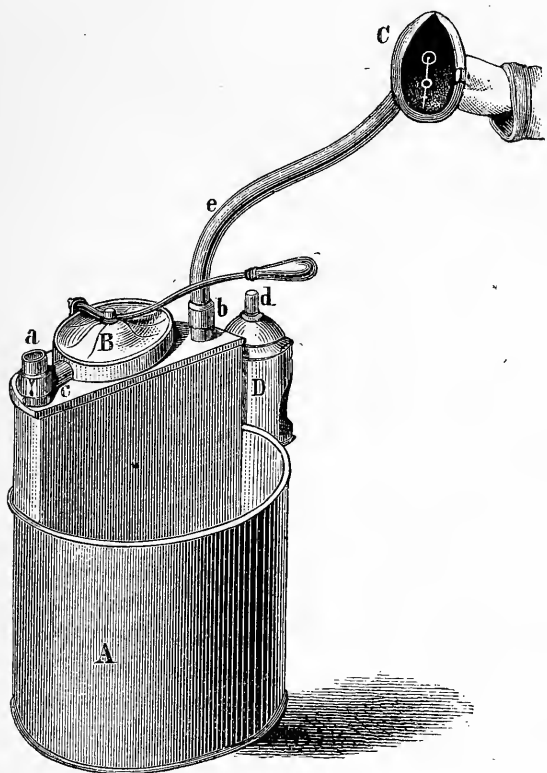

FIG. 18.

bellows, and the other *e* is connected with the mask *A*. The tube *c* communicates with the bellows, which is connected with the lid by means of a double valve, and is so constructed that by manipulation of the plug which closes it air can, by means of the bellows, be pumped into the receiver from the atmosphere, or on the other hand pumped out, and thus the air within it can be either condensed or rarefied. The boiler *D* to

the right of the air-receiver warms the compressed air when it is employed. For if we close the tube *b* and place the flexible tube at *d*, the air streams through the boiler *D*, where it can be warmed or charged with medicinal substances. The mask, which is made of metal with an indiarubber rim, opens freely outwards, but is furnished on the side next the tube with a spring valve. A simple arrangement enables the patient, by laying a finger upon it from without, to open the valve as soon as he closes the larger orifice. To use the apparatus, the valve is first closed and it is then half filled with water, which stands at the same level in both compartments. The valve is now placed according as the object is to produce compression or rarefaction of the air, and the bellows set in motion. In the former case air is forced into the receiver with every turn of the pump; the water sinks in it and rises proportionately in the open half. In the second case air is drawn out of the receiver with every action of the bellows; the water rises in it and sinks proportionately in the open compartment. The pressure under which the air in the receiver is condensed or rarefied is the result of the difference of the water-level in the open and closed half of the cylinder, and may be read off on the former by marked lines.

If compressed air is to be inhaled, then the patient, when the air in the receiver is sufficiently condensed, closes with his finger the outer orifice in the mask which fits on airtight, and so compresses at the same time the spring which closes the valve, and inspires the air that streams out; in the opposite case, if the patient is to expire into rarefied air, he breathes freely in and out, and when he has completed an inspiration by pressure of the finger he changes the communication of the mask, whereupon, with more or less of a feeling of constriction, a part of the residual air streams out of the lungs and into the air receiver, in consequence of which the water begins to rise in the outer space. With each respiration the pump must be worked afresh and continuously. The condensation and rarefaction of the air to be obtained by means of this apparatus ranges between a pressure of  $\pm \frac{1}{9} - \frac{1}{4}$  atmosphere.

The defects of this apparatus, apart from the fact that an assistant is generally necessary for its management, are, first, that

the air pressure obtainable by it is far too slight, and frequently that it is not constant, as the pressure in the air-receiver varies with each respiration. It is therefore necessary to work the bellows continuously, and thus during each respiration to obtain condensation and rarefaction of the air only spasmodically.

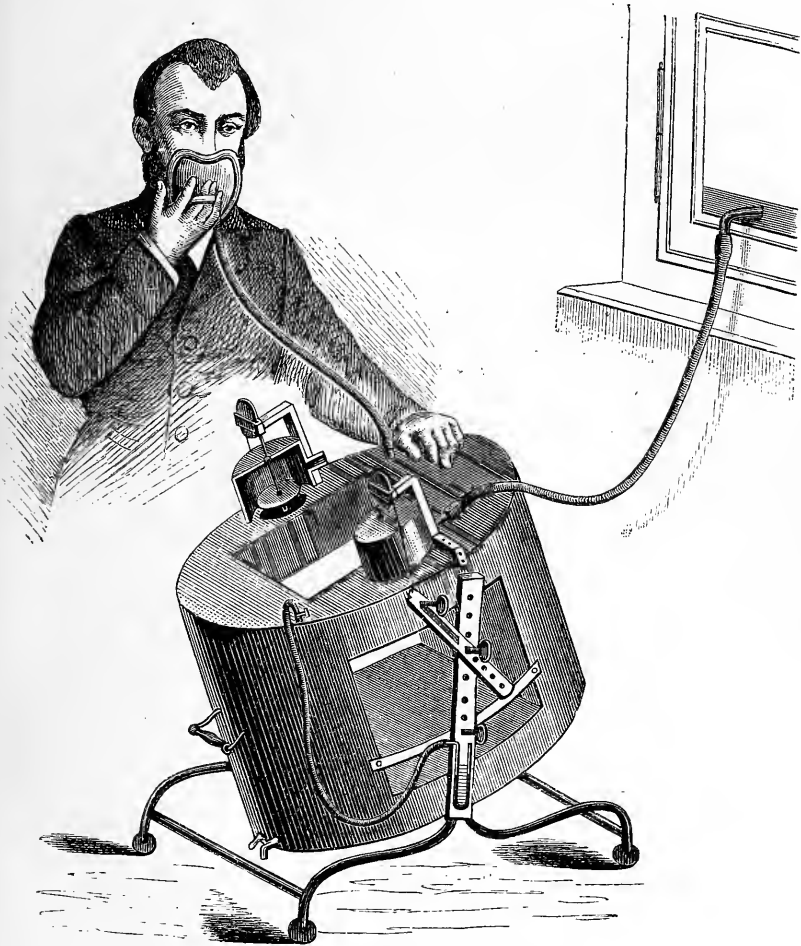

FIG. 19.

For this reason Hauke's apparatus is but little adapted for scientific experiments, and its therapeutic effect also is essentially diminished by these defects.

## 2. *Störk's Apparatus.*

On the principle of the pressure of fluids in communicating tubes Störk constructed an apparatus (fig. 19) which consists of a double leaden boiler, the partitions of which communicate by a connecting tube and are closed by stop-cocks. Only one of the partitions has a lid, while the other has an open orifice. The double boiler is suspended between two screws or an iron stand, so that it can be easily moved.

Störk effects the compression and rarefaction of the air simply by inclining the apparatus to one side or the other, when, according to the law of communicating vessels, the water flows over towards the inclined surface and thus condenses or rarefies the air in the closed half, answering to the inclination of the vessel.

As the regulation of the pressure for artificial respiration rests only on the modification of the inclinations of the boiler, which the patient or an assistant must manage, the pressure that is to be obtained is never therefore sufficiently accurate and is also inconstant, so that the same defects which render Hauke's apparatus unfit for scientific and therapeutic purposes also apply to that of Störk, and stand in the way of its general adoption.

### (B) APPARATUS CONSTRUCTED ON THE GASOMETER PRINCIPLE.

#### 1. *Waldenburg's Apparatus.*

Waldenburg's apparatus, considerably improved in its second form, consists of a cylindrical vessel 1 metre long and 30 centimetres in diameter, in which moves a second cylinder open at the bottom, closed at the top, of equal height, and 27 centimetres in diameter (fig. 20). The upper part of the outer cylinder is widened for 10 centimetres of its length to the extent that the diameter of the widened part is exactly double the diameter of the inner cylinder, i.e. 54 centimetres. The lid of the inner cylinder is no longer fitted on to the upper margin, as was formerly the case, but at a distance of 8 centimetres below it, which exactly answers to the water-level when the cylinder is full. The outer margin of the inner cylinder has, however, retained the full height of 1 metre, as before. By these modifications, which were absent in the first apparatus,

which consisted simply of two cylinders moving within one another, of the above proportional dimensions, the water-level of the cylinder, which formerly could only be filled up to 20 centimetres, can be brought up to 8 centimetres, and the calibre of the cylinder can be completely utilised for the use of compressed as well as rarefied air, whereas previously, when the apparatus had been filled higher with water, it would run over under strong compression. Then, by the deeper insertion of the cover in the inner cylinder, when the latter touches the bottom, all air is excluded from it, the water now reaching up to the lid. Formerly when this was the case a considerable residue of air remained behind—namely, so much as the inner cylinder could hold from its lid to the water-level; when the water stood

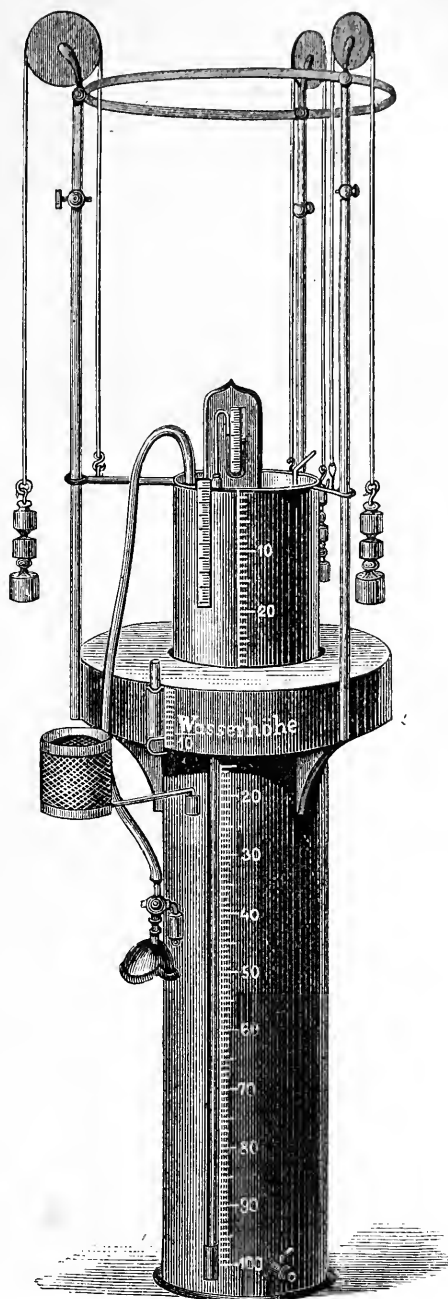

FIG. 20.

at 20 centimetres, this amounted to 11,460 cubic centimetres of air. This drawback became particularly inconvenient when formerly expiration was made into rarefied air; the residual air then not only contained a large amount of carbonic acid, but under certain circumstances also other products of expiration, which might possibly be injurious in their influence and necessitated frequent and thorough ventilation. In the new apparatus the only residual air is the small amount in the pipe, and this, by raising the inner cylinder up a little and lowering it again, can be thoroughly mixed with the outer air and thus ventilated. Finally, in order to prevent contamination from the entrance of dust, the upper widened part of the outer cylinder has been furnished with a firm lid. Both cylinders are made of sheet zinc.

The movement of the cylinders one within the other is effected by the following arrangement:—Three metal rods, a little over a metre in length, rise from the widened upper part of the outer cylinder; these are connected with one another by a movable hoop, and each rod is surmounted by a wooden wheel; over these wheels run chains which are fastened internally to the anterior part of strong metal rods which run from the inner cylinder towards the margin of the outer one; the free extremities of the chains which hang down outside have hooks to which weights can be attached. These horizontal metal rods serve at the same time to steady the inner cylinder in its movements within the outer one, while they terminate in front in forked extremities, so as to enclose loosely the outer bars of the apparatus. On each of the outer bars is attached a movable clamp, which is best fastened at a height of 83 centimetres, where there is a groove; it prevents the jerking up of the forks of the inner cylinder.

There are two openings in the cover of the inner cylinder; one communicates by a flexible tube with the mask; a quick-silver manometer divided into millimetres, up to 40 millimetres above and below, fits airtight into the other.

The outer cylinder has near the bottom a stopcock to allow the water to run off, also a glass tube communicating with it runs along it from the top to near the bottom—with centimetre divisions corresponding to those of the cylinder—on which the level of the water in it may be read off.



The inner cylinder is also divided into centimetres, beginning at the upper margin with 0, and ending at the lower with 100. Besides this, Waldenburg has had inserted into the upper part of it, according to its capacity, a scale in cubic centimetres—from 10 to 100 up to 10,000 cubic centimetres—which allows of the use of the apparatus as a spirometer.

A close-fitting tin mask for the face, bound round the edge with indiarubber, is mounted upon a brass peg, which is connected with the flexible tube leading to the apparatus. On the peg there is a T-shaped perforated stopcock with wide bore, by the turning of which the mask is made to communicate with the air of the inner tin cylinder only, while the outer air is excluded, or on the other hand freely with the outer air, while the apparatus is entirely closed.

Waldenburg usually has three sizes of masks kept in stock. The medium size fits most adults. It is generally easy to make the mask fit closely by a little manipulation if it does not do so originally, but moustaches may interfere with its fitting airtight. Whether it is completely closed or not, the apparatus can be regulated most accurately. E.g. if compressed air be inhaled by means of the mask, the cylinder sinks down only so long as the patient inspires; afterwards the cylinder must remain fixed immovably. The same holds good for expiration into rarefied air. From considerations of cleanliness, as well as on account of any possible contagion, it is desirable that each patient should have his own mask. The cock of the mask is easily handled, so that no patient will find any difficulty in regulating himself its opening and closing and so managing the apparatus in the different parts of the respiratory act. The help of an assistant is quite unnecessary in the employment of Waldenburg's apparatus, if the patient is only properly instructed.

The working of the apparatus, according to Waldenburg, is as follows:—

Fill the outer vessel with water up to a given height, and let the inner vessel glide down to the bottom, the air meanwhile escaping freely through the mask; then close the stopcock in the mask and hang weights on to the hooks; then—assuming they are heavier than the inner cylinder—they will

immediately draw the latter up to a given point, to be accurately determined, and thus rarefy the air within to an extent that may be regulated with precision. The heavier the suspended weight, the greater will be the rarefaction of the air. The degree of rarefaction can be easily read off on the quicksilver manometer; this answers almost completely to the estimate obtained by calculating the effect of the weights suspended. At the same time the water sinks in the outer vessel, and its level can be read off on the glass tube, and rises in corresponding ratio in the inner vessel. If we now open the stopcock of the mask, so that the air of the cylinder communicates with the outer air, then the inner cylinder sucks in air from the atmosphere and ascends, but the degree of rarefaction of the air within it remains constant, which is theoretically necessary according to physical laws, as the unaltered traction of the same weights acts permanently, as is visible to the eye by the manometer standing at the same level. If now the inner cylinder, instead of communicating with the outer air, is by means of the mask brought into communication with the lungs in respiration, then there follows, in the same way, with constant force, a suction of the pulmonary air into the apparatus.

The cylinder continues to rise till it is lifted out of the water. To prevent its too sudden rise and possible injury to the apparatus thereby, the clamps already described are fixed to the iron rods and stop the cylinder from rising higher. If the apparatus is filled with water up to a height of 8 centimetres, marked on the outer cylinder as 'water height,' (Wasserhöhe) then the inner cylinder can rise when the air is rarefied by  $\frac{1}{10}$  atmospheric pressure up to a height of about 83 centimetres before it is lifted out of the water. As  $\frac{1}{10}$  atmospheric pressure is that most frequently employed, it has been thought best to screw on the clamps at that height, where there is also a groove for them in the iron rods. If slighter rarefaction of the air is desired, the clamps may be screwed on higher; if greater, lower; or, what is more convenient, in the latter case we must take care that the cylinder does not rise quite as high as the clamps. If the height of the water-level in the apparatus is altered, these conditions also change accordingly.

If, on the other hand, the object is to employ compressed air,

then by means of the weights draw up the inner cylinder, the stopcock being open; next close the stopcock; remove the weights, and place them instead in the dish-like hollow above the lid of the inner cylinder. These, together with the weight of the cylinder itself, compress the air within it, as shown by the manometer, and at the same time the water sinks in the inner and rises in the outer vessel. If we make communication, by opening the stopcock, with the outer air, or cause the patient to inspire through the mask, then the cylinder sinks, but the air within it, in this case also, maintains constantly its original degree of density, as the manometer shows, till the inner cylinder has reached the bottom of the outer one.

We can read off on the scale of the inner cylinder how many centimetres the cylinder has fallen or risen with each respiration, whether in inspiration or expiration. As the capacity of the cylinder for every centimetre of height is known—it is calculated at about 573 cubic centimetres—therefore it can be accurately determined how much air is either withdrawn from the cylinder with every inspiration or added to it at every expiration.

The working power of the apparatus can be very easily found according to the given ratios.

The weight of the atmosphere upon a square centimetre of surface is known to amount to an average of 1033 grammes. The surface of the inner cylinder of our apparatus ( $r^2\pi$ ) amounts to  $(\frac{27}{5})^2\pi$  = about 572·8 square centimetres. The pressure of an atmosphere upon that is therefore reckoned at 1033·572,8 grammes = 591,7 kilogrammes = about 1183 lbs. According to this it is easy to reckon to what pressure of atmosphere any number of weights that are placed or suspended on the apparatus corresponds.

If instead of 1183 lbs. we take the round number of 1200 lbs. = 600 kilogrammes, an amount which may be wholly or partially compensated by friction, even though this be slightly reduced, the results are the ratios given in the following table:—

Lbs.	Atmospheric Pressure	Mercury Pressure= Millimetres	Water Pressure. Centimetres
1200	1	760	1033
1	$\frac{1}{1200}$	0.63	0.86
3	$\frac{1}{400}$	1.9	2.6
5	$\frac{1}{240}$	3.1	4.3
6	$\frac{1}{200}$	3.8	5.2
8	$\frac{1}{150}$	5.1	6.9
10	$\frac{1}{120}$	6.3	8.6
12	$\frac{1}{100}$	7.6	10.3
15	$\frac{1}{80}$	9.5	13.0
17	$\frac{1}{70}$	10.9	14.8
18	$\frac{1}{67}$	11.4	15.3
20	$\frac{1}{60}$	12.6	17.2
24	$\frac{1}{50}$	15.2	20.6
25	$\frac{1}{48}$	15.8	21.5
27	$\frac{1}{44}$	17.1	23.3
30	$\frac{1}{40}$	19.0	26.0
33	$\frac{1}{36}$	21.1	28.7
35	$\frac{1}{34}$	22.1	30.3
36	$\frac{1}{33}$	22.8	31.0
40	$\frac{1}{30}$	25.3	34.4
42	$\frac{1}{28} - \frac{1}{29}$	26.6	36.3
45	$\frac{1}{26} - \frac{1}{27}$	28.4	38.7
48	$\frac{1}{25}$	30.4	41.3
50	$\frac{1}{24}$	31.6	43.0
55	$\frac{1}{22}$	34.7	47.3
60	$\frac{1}{20}$	38.0	51.6

The figures given in this table for mercury and water pressure correspond to the medium elevation of the barometer and are subject to the variations of atmospheric pressure. The water manometer in the apparatus of course does not show these figures, but quite different ones. As already mentioned, it only shows the height of the water in the outer cylinder, and its height in the inner one must be calculated from that. The difference of the two marks the water pressure.

It must also be remembered that the weight of the inner cylinder itself is also to be taken into account in the calculation: this amounts to something over 10 lbs. If our object is to compress the air, we therefore place upon the cylinder a weight 10 lbs. less than that the effect of which we wish to obtain; conversely for rarefaction of the air, 10 lbs. more must be suspended to it. If, for example, we wish to apply a pressure of 30 lbs. = 19 millimetres mercury pressure =  $\frac{1}{40}$  atmosphere, we must place only 20 lbs. on for compression on the other hand, for rarefaction suspend 40 lbs.

*The Employment of the Apparatus as a Spirometer.*

If we suspend on the chains of the apparatus weights equal to the weight of the inner cylinder, viz. 10 lbs., it remains in equilibrium at every height if the stopcock is open. It then represents a perfect spirometer, and 1 centimetre of cylinder height answers to 573 cubic centimetres of capacity, and we have only to multiply the number of centimetres which the cylinder rises to find the value of the vital capacity of the lungs. In order to avoid multiplication and to be able to read off small values, Waldenburg had an accurate scale constructed, in which every dividing line corresponds to 100 cubic centimetres capacity of

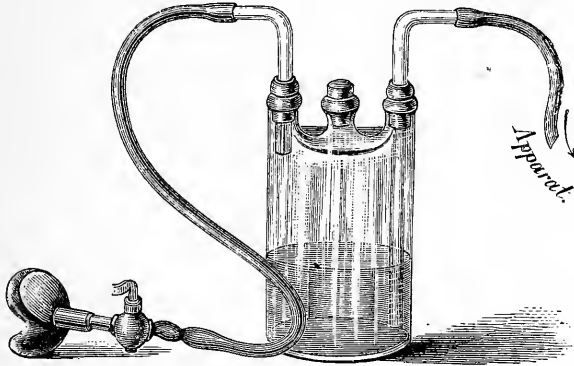

FIG. 21.

the cylinder. This scale, which goes up to 10,000, is attached to the upper margin of the cylinder. In order to balance the cylinder exactly and to avoid friction as much as possible it will be better, instead of 10 lbs., which is the weight of the cylinder, to use 12 lbs., i.e. 4 lbs. placed on each chain and 2 lbs. on the lid of the inner cylinder; lesser differences can then be adjusted by grains of shot.

For inflation we make use either of the mask or of a special mouthpiece, or of the terminating piece of the stopcock which usually serves in fixing on the mask.

Lastly, Waldenburg had a metal groove affixed to the anterior surface of the outer cylinder, and a flask-holder made to fit into it which receives a Wulff's flask (fig. 21), in case we

wish to use it for warming the air to be inspired or for combining it with medicinal inhalations. The advantages of this apparatus both for therapeutic and scientific purposes are unmistakable. By simply increasing or diminishing the weights, every degree of condensation or rarefaction of the air within a pressure action from  $\pm \frac{1}{150}$  up to  $\frac{1}{30}$  atmosphere can be obtained with all desirable accuracy, and this degree can be maintained constant during the whole employment of the apparatus. Easily transportable, it is equally adapted by its construction for the application of compressed and rarefied air intermittently, or, if two apparatus are combined, also alternately, without any other help being necessary to set it or keep it in activity. Finally, its availability as a spirometer may also be a very desirable aid to the practical physician.

## 2. *Cube's Double Apparatus.*

The apparatus of Hauke and Waldenburg is each complete in itself, and they only admit of the inspiration of compressed air and expiration into rarefied air at separate sittings; they are specially adapted for those indications in which a mechanical influence is to be exercised upon the surface of the respiratory organs either by raising or lowering the air pressure. An alternate raising and lowering of the air pressure above and below the atmospheric pressure by inspiration of condensed and expiration into rarefied air can only be obtained by combining two apparatus together, in which case the stopcock which either admits or excludes the air has, at the orifice which otherwise communicates with the external atmosphere, a tubular plug on which the flexible tube of the second apparatus is fastened. According to the position of the stopcock, the mask then communicates either with the apparatus in which the air is compressed or with the other in which the air is rarefied. If the lever of the stopcock stands exactly in the middle, it closes both apparatus airtight.

Cube was the first to construct a double apparatus (fig. 22) with which it is possible alternately to inspire condensed air and expire into rarefied air, and in this way to obtain on the one hand an energetic influence over inspiration and expiration,

on the other hand an abundant ventilation of the lungs and stimulation of the elasticity of the lung-tissue. There is no doubt whatever that the method first originated by Cube is of practical value and in the given case most efficient in its action, although on the other hand the urgent necessity of its application has been questioned, because approximately similar results can be obtained by intermittent employment of compressed and rarefied air. Yet the construction of a double apparatus would seem to be indispensably necessary (for, as in the house of a physician or in an institution, it is used not by one patient only, but by many in turn), not only from considerations of

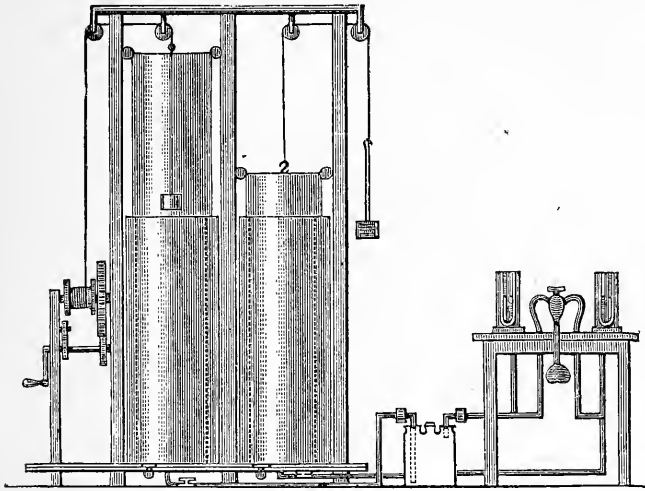

FIG. 22.

cleanliness, but still more with regard to the danger of contagion, if patients inhale out of a cylinder into which other patients have previously expired. Ventilation by repeatedly filling and emptying the cylinder will indeed purify the air in the apparatus, but not the water, which may also be impregnated with exhaled substances and contain infectious matter. After the experiments which have recently been made with regard to the transmissibility of tuberculosis, redoubled caution becomes necessary in the use of the apparatus. In Cube's apparatus one cylinder serves exclusively for inspiration, the other for expiration; both may be combined together or each

may be used separately. The apparatus is on a larger scale than those devised by other authors, and therefore less transportable, but by its larger cubic capacity of longer continuous activity and constant pressure. Its construction is as follows :—

Upon a strong wooden board 1·60 metre in length and 0·75 metre in breadth rise vertically 3 wooden supports 3 metres high, fastened firmly below with iron lateral stanchions to the wooden stand and joined above by a cross beam. Between these supports the inspiratory and expiratory apparatus are so placed that their central points lie under the cross beam. Each of these apparatus consists of a reservoir of water and a bell (*Glocke*). The former is a zinc cylinder closed below, 1·50 metre in height and 0·70 metre in diameter, which for the sake of strength is encircled by 3 strong iron hoops. This, when filled, would contain 577 litres of water = 1154 lbs. In order to reduce this enormous weight of water a second zinc cylinder equal in height, but only 0·60 metre in diameter, is inserted into each of them, riveted and soldered airtight to the bottom of the reservoir. Thus we get a circular vessel, the walls of which stand 0·05 metre apart from one another, and which requires only 153 litres = 306 lbs. to fill it. Into this ring of water is now sunk the air cylinder, open below and closed above, the so-called 'bell.' It also is made of zinc, is 1·45 metre high and has a diameter of 0·65 metre, and is suspended above by a chain which runs over a pulley fastened to the cross beam. The vertical movement up and down of the bells is secured by two running wheels attached to the top of each of them, which run upon bars that are let into the wooden supports. In order to completely prevent lateral oscillations, which may materially interfere with the constancy of pressure or traction, each bell is also furnished at its lower margin with 5 small brass rolling wheels, which run along the zinc wall of the water reservoir. Whereas now the bell of the expiratory apparatus in its function is simply drawn up by corresponding counterweights which hang down at the side of the outer pillar over a second pulley attached to it, and so produces a chamber of rarefied air, the bell of the inspiratory apparatus, on the other hand, is furnished with a simple contrivance affixed to the opposite outer side for drawing



it up, as is easily understood from the drawing. The inspiratory as well as the expiratory apparatus has at the bottom 3 iron conduit tubes closable by stopcocks, two of which communicate at the bottom of the reservoir with the inner air space, but the third communicates only with the side wall and serves to let off the water. In the inspiratory apparatus one of the two air-tubes, 20 mm. in diameter, leads into the open air, while the other, 15 mm. in diameter, goes to the so-called operation table. In filling the bell the stopcock of this last tube is closed, and through the open cock leading into the open air fresh air streams into it as it is wound up. When the bell has been raised, the stopcock is closed, the winding-up apparatus is set free, and the air is compressed for use. In the expiratory apparatus the wider tube, 20 mm. in diameter, leads into a well-drawing vent (chimney, stove, or into the open air), into which the products of expiration are carried. It is needless to say that the weights suspended outside on the chain must now be taken off, whereby the bell by its own weight sinks into the water, and that during this time the second cock leading to the operation table remains closed; also that, after the bell has sunk to the bottom, the cock leading to the vent is again closed and the weights are again hung on the chain, by which the vacuum is at once created. Of the tubes leading to the operation table the tube coming from the inspiratory apparatus goes first through a large Wulff's flask, in which for the respective cases the air to be inspired can be impregnated with aqueous vapours, gases or volatile substances, and which simply remains empty when only pure air is to be operated with, and then runs, together with the tube coming from the expiratory apparatus, into one common cock; previously, however, both tubes have branches as manometers, which consist of U-shaped bent glass tubes, about 40 centimetres long, with centimetre division, and half-filled with water. The common stopcock, fastened in a stand on the operation table, is so constructed that by being turned a quarter round its orifice of discharge communicates alternately with one and the other tube. As now the orifice of discharge is connected by a flexible tube with the face-mask or a simple mouthpiece of glass or ivory, the patient, after a complete inspiration, can by the

quarter turning of the stopcock immediately begin expiration, or by the quarter turning in the opposite direction simply stop the admission of air till the next respiration. In the same manner, as is obvious, expiration only can also be undertaken.

Now v. Cube has assumed, with regard to pressure action, that in compression the lowest pressure to be applied must amount to at least 10 centimetres water pressure, or an excess of about  $\frac{1}{100}$  atmospheric pressure; and as the bell has a surface of 0.65 diameter  $\frac{65^2\pi}{4} = 3316$  cubic centimetres. But 10 centimetres water pressure is equivalent to a weight of 10 grammes per centimetre; therefore v. Cube originally gave to the bell of the inspiratory apparatus the weight of  $3316 \times 10$  grammes = 33160 = about  $66\frac{1}{3}$  lbs., suspending the weight wanting to the zinc on a stiff iron wire within the bell, in order at the same time to place the centre of gravity as low as possible. For the purpose of increasing the pressure, leaden discs are cast, furnished with a slit, in order that they may be placed as centrally as possible upon the bells, each of which weighs 3316 grammes (about  $6\frac{2}{3}$  lbs.), so that every disc laid on increases the compression of the air by 1 centimetre water pressure, or increases the atmospheric pressure by  $\frac{1}{1000}$ ; therefore

5 discs give 15 centimetres	= $\frac{15}{1000}$	atmospheric pressure
10   "   "   20   "	= $\frac{20}{1000} = \frac{1}{50}$	"   "
15   "   "   25   "	= $\frac{25}{1000} = \frac{1}{40}$	"   "   &c. &c.

Negative pressure can also be reckoned and obtained by suspending the same 3316 gramme weights on the chain after the equilibrium of the bell has been restored. As the diameters of the bells are equal, each disc laid on produces a rarefaction of the air corresponding to 1 centimetre water pressure ( $\frac{1}{1000}$  atmosphere).

### 3. *Tobold's Apparatus.*

Tobold has devised a cheaper apparatus, which is constructed after the pattern of Waldenburg's and Schnitzler's apparatus, and in which everything non-essential is left out. The dimensional proportions are also somewhat reduced. There is also a special contrivance added for warming the air to be inspired. As the apparatus is exact and constant, and the price very moderate, little exception can be taken to Tobold's practical idea.

4. *Weil's Double Apparatus.*

Weil at Berlin has constructed a serviceable double apparatus (fig. 23), by combining together two Waldenburg's apparatus inferiorly by a short indiarubber tube, so that while one cylinder sinks the other rises, and conversely, so that the one is again ready for use as soon as the other has ceased to act. The apparatus was not devised with the object of an alternating respiration, but, as in the one afterwards invented by

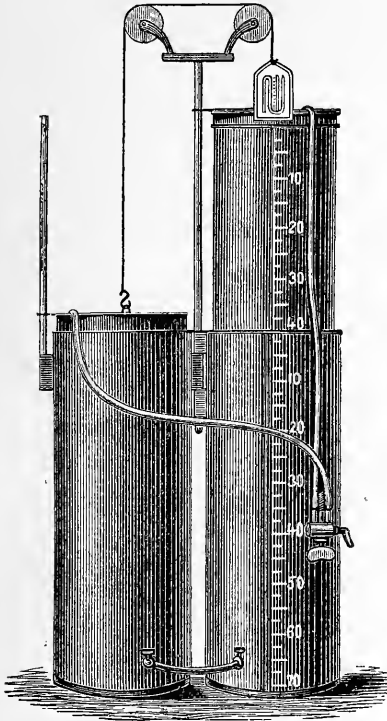

FIG. 23.

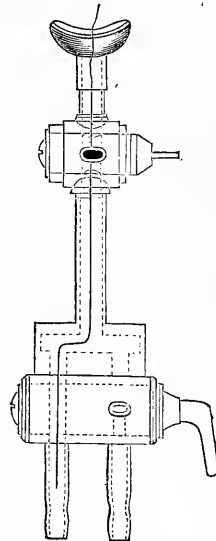

FIG. 24.

Schnitzler, in order to be able to employ compressed or rarefied air uninterruptedly. The double stopcock (fig. 24), to which the two respiration tubes are affixed, possesses a twofold perforation, through which, by means of a half-turn, a cylinder can be made to rise or sink, while the respirations are regulated by the cock of the mouthpiece, with which again the double cock is

connected. Waldenburg also adds a similar cock in order to use two of his apparatus for the same purpose.

### 5. Schnitzler's Apparatus.

#### (a) *The Simple Apparatus.*

On the principle of the gasometer, as introduced by Waldenburg into pneumatic therapeutics, Schnitzler also devised an apparatus which, being only a modification of Waldenburg's, possesses all the advantages of the exact and constant pressure action of the latter, with only such alterations as long use has shown to be desirable for convenient application. Thus the inner cylinder does not run on conducting rods above the outer cylinder, but in conducting grooves connected with the outer one; the management of the weights for producing positive or negative pressure in the bell is made easier for the patient; the respiration tube does not proceed from the upper lid of the inner cylinder, but from the lower lid of the outer, and passes thence to the inner cylinder. Schnitzler has also introduced convenient contrivances for examining the respiratory air and conveying gases to the respiratory air; he has also simplified the use of the apparatus as a spirometer by bringing the inner cylinder into equilibrium, and devised a contrivance by which his manometer can be used as a pneumatometer.

Schnitzler's apparatus (fig. 25) consists essentially of a tin cylinder A, which stands below on a broad basis and is expanded above, in order to prevent the overflow of the water, and of a bell B lowered into it, to which three conducting rods C are fastened. For safer and better conduction the latter are inserted into the conducting grooves D which are placed on the outer side of the cylinder A. At the lower end of each conducting rod there is a projection E, to which is fastened the chain G which winds round the pulley F. Together with this pulley a second H is fixed on the same axis, to which by means of a second chain the balancing weight J is fastened. The pulley H is fixed to the axis; the pulley F is fixed to it by a pivot, whereby the force that acts on the chain of the one pulley can be transferred to that of the other.

If now the outer cylinder is filled with water up to a

certain height, and then an extra weight *K* suspended on the balancing weight *J*, the bell *B* is lifted and the enclosed air rarefied.

The degree of rarefaction may be read off on an open

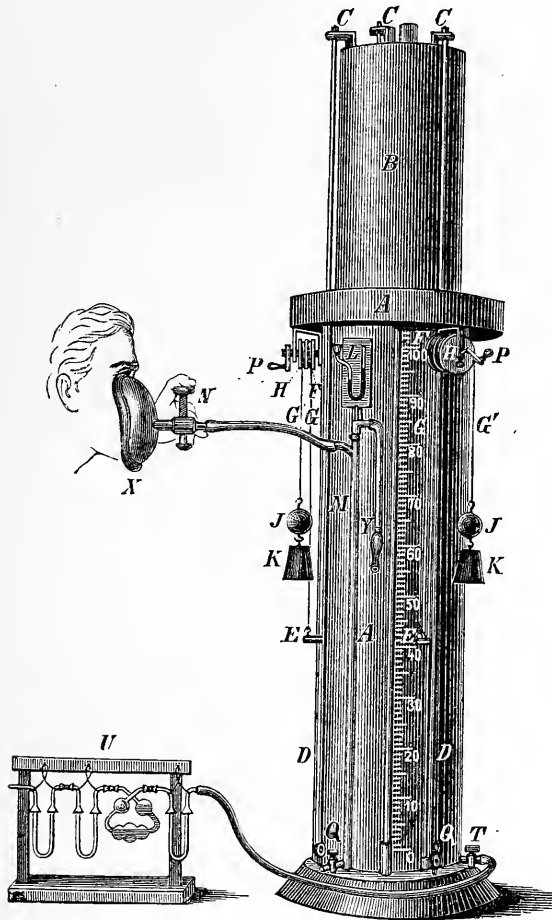

FIG. 25.

mercury manometer which is affixed to the tube *M*, which after making two bends passes into the bell *B*.

If the two stopcocks *N* and *T* are opened, or even only one of them, air enters into the bell till it is quite filled with atmospheric air, or the extra weight ceases to act.

If now we desire to bring back the bell into its former position or compress the air within it, we have simply to push forward the pivot into the pulley H, whereby F becomes free; in consequence of this the balancing weight is thrown out of action, and the bell will by its own weight first compress the air, and as soon as the stopcock is opened sink down.

Should, however, the air within the apparatus become more condensed than occurs through the weight of the bell alone, it is only necessary to pass the chain fastened to the loose pulley F over the pulley Q at the foot of the apparatus, draw up the weight and push back the pivot into the roller H, by which the former traction upwards is changed into the opposite.

If the bell is completely lowered and we want to draw air into it, we elevate the balancing weight again by means of the winch P, unite again the two pulleys, which have become loosened during the drawing up of the winch, and then suspend the extra weight K according to the desired rarefaction of air.

In order to be able to measure the quantity of the air admitted or withdrawn, an indicator is affixed to one of the conducting rods, with a centimetre division which shows how much the bell has risen or fallen.

If the air within the bell is to be analysed, or a gas conducted into it, we have only to connect the arrangements for the purpose with the stopcock T, as is represented by the apparatus U and V (fig. 26).

In order to ascertain the existing level of the water in the apparatus a water-level tube is affixed, R, which is furnished with a centimetre division. A stopcock S near it serves to empty the apparatus.

The whole apparatus has a height of 120 centimetres, the outer cylinder a diameter of 28, the inner a diameter of 25.25 centimetres.

The pressure, i.e. the condensation and rarefaction of air, may be reckoned in a very simple manner.

The surface of the bell ( $=r^2\pi=12.625 \times 12.625 \times 3.14$ ) amounts to 500.486, in round numbers therefore about 500 cubic centimetres.

The weight of one atmosphere upon a square centimetre amounts, as is well known, to 1033 grammes. This gives in the case of our apparatus  $1033 \times 500 = 516.5$  kilos.

We shall, however, hardly fail of our purpose if we for simplification of the reckoning assume the pressure of the atmosphere upon the surface of our apparatus in round numbers as 500 kilos. = 1000 tariff lbs., from which afterwards the pressure of each separate weight applied can easily be estimated.

The corresponding figures in this apparatus are:—

Lbs. =	Atmospheric Pressure =	Mercury, Millimetres
1000	1	760.0
100	$\frac{1}{10}$	76.0
50	$\frac{1}{20}$	38.0
40	$\frac{1}{25}$	30.4
30	$\frac{3}{100}$	22.8
20	$\frac{1}{50}$	15.2
10	$\frac{1}{100}$	7.6
1	$\frac{1}{1000}$	0.76

We can thus, by increasing and diminishing the weights, raise and lower the positive and negative air-pressure at pleasure, and this pressure in the apparatus also remains unaltered during the whole time of use, as anyone can convince himself by each glance at the manometer standing in communication with the bell.

In the compression of the air the weight of the bell must be taken into account. This presses with its whole weight on the enclosed air, as soon as all the pulleys are set free by the pushing forward of the pivots. The bell of the apparatus weighs something over 20 lbs.; its weight alone will therefore produce over  $\frac{1}{50}$  of an atmospheric pressure.

In order to be able to use the apparatus for inspiration and expiration, an indiarubber tube, 40 to 50 centimetres in length and somewhat over 1 centimetre in width, is affixed to it, as has been already mentioned, to the anterior extremity of which a sliding valve furnished with a mouthpiece is fixed. This consists of a metallic tube about a centimetre in diameter, which by means of simple pressure with the finger can be brought into communication with the air in the bell or with the external atmosphere. Thus it becomes possible to retain the

mouthpiece constantly in the mouth during inhalation, and at the same time, according as the slide is directed, to inspire at pleasure atmospheric air and then to expire into the bell, or, conversely, to inspire air out of the bell and expire into the atmosphere. The patient can also remove the mouthpiece every time from his mouth and again replace it in his mouth, if he wishes to bring his respiratory organs into communication with the air in the bell.

In respiration by means of a mouthpiece this must be placed

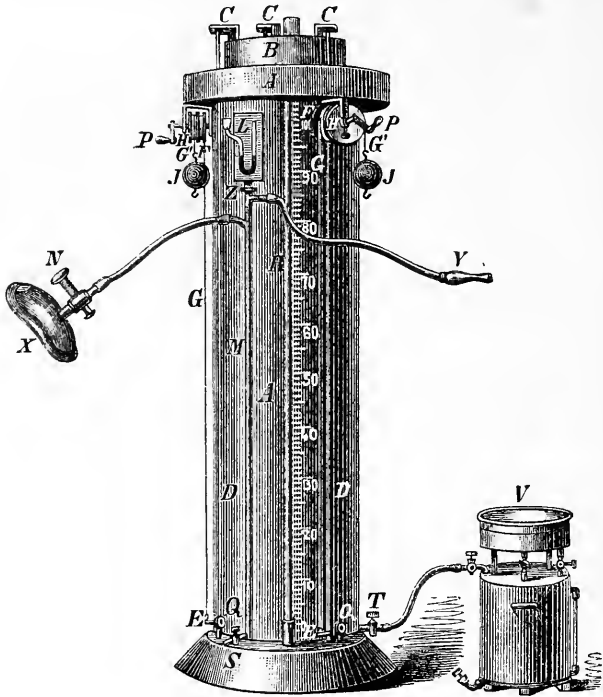

FIG. 26.

quite deep in the oral cavity (at least 1 to 2 centimetres), and not, as often happens, be merely held between the lips. At the same time the tongue must be somewhat forced down, and the lips must be firmly closed. The mouthpieces may be made of hard indiarubber, ivory, meerschaum, or glass.

Instead of the mouthpiece a suitable mask for the face may be employed, which fits airtight over mouth and nostrils. The



mask which Schnitzler employs in his apparatus is of india-rubber, hemispherical in shape, and is exactly large enough to enclose mouth and nose. It is made airtight by an air pad fitted round its margin, which lies close and easily all round.

The mask and the mouthpiece can be easily detached from the sliding valve, thus enabling the physician to provide without much expense masks and mouthpieces for his different patients.

If the apparatus is to be used as a spirometer, the bell is first lowered to the bottom, then filled up with water to a certain height, somewhat over 100 centimetres being the best, and the stopcocks *N* and *T*, which were open during the lowering of the bell and the filling of the vessel, are closed. By the equilibration of the cylinder we can at once estimate the vital capacity of the lungs, either by inspiration into it or, when it is first filled with air, by inspiration out of it. As every centimetre which the bell rises or falls corresponds to 500 cubic centimetres of air, it is easy to calculate the vital capacity of the lungs by multiplying the centimetres of the rise or fall by 500.

Schnitzler has quite recently added a simple contrivance to the manometer of his respiratory apparatus, by which it can be also used as a pneumatometer (fig. 26). A stopcock *Z* is attached to the manometer, by the turning of which the communication with the bell is interrupted, that with the outer air established. On the stopper, which communicates outwardly, a thin indiarubber tube with mouthpiece *Y* or mask *X* is affixed. If now, by turning the stopcock, communication is established with the outer air instead of with the bell, the manometer may quite well be used as a pneumatometer.

(b) *The Continuously Acting Apparatus.*

Besides his simple apparatus acting interruptedly, Schnitzler has also constructed one which acts continuously (fig. 27), and in the form of a double apparatus admits of the inspiration of compressed or the expiration into rarefied air to be carried on during a whole sitting without interruption, and, like the simple apparatus, it can also be used for alternate and intermittent

application of compressed and rarefied air, and also as a pneumotometer and spirometer.

Following Schnitzler's descriptions, the double apparatus consists of an oval tin vessel A, open above and closed below, 75 centimetres high, 54 centimetres long, and 27 centimetres wide, within which are 2 cylinders B and C, also of tin, closed

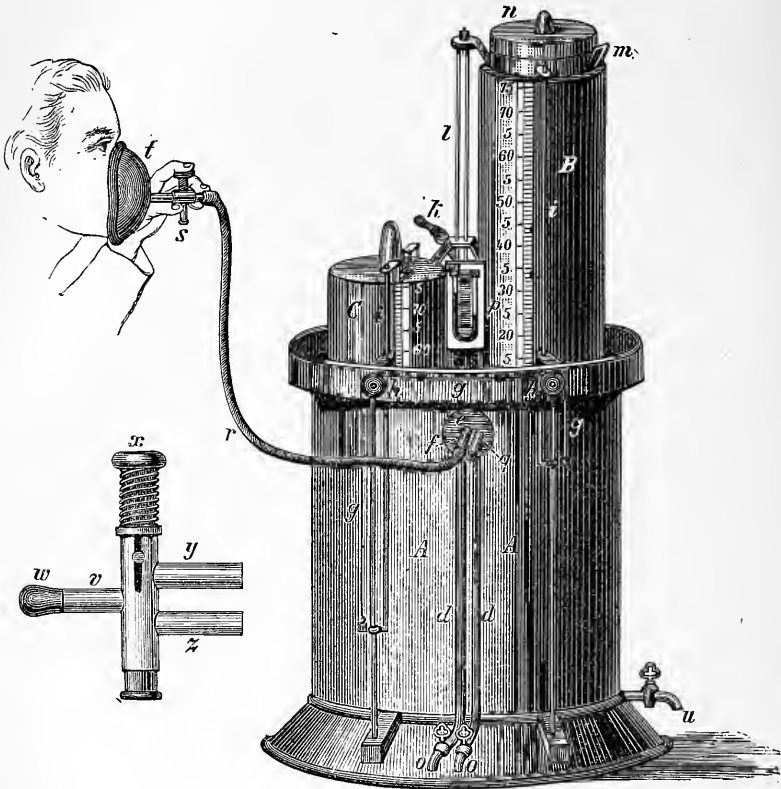

FIG. 27.

above and open below, 75 centimetres in height with a diameter of 25·25 centimetres. From the lid of each cylinder rises a small conical elevation 5 centimetres high and 2·5 centimetres wide. (Although immaterial, it may be here mentioned that the outer vessel is widened above into a projecting rim, 5 centimetres wide and 5 centimetres high, and is expanded at the base to about the same extent, where it is somewhat curved.)

Through the centre of the 2 cylinders pass 2 tubes  $d d$ , somewhat over 2 centimetres wide, which reach above to the summit of the conical projection and emerge at the bottom of the outer cylinder, where they are bent at right angles, and perforate a brass plate soldered in the middle of the anterior surface, which forms a part of the discoid stopcock  $e$ , of great importance in the working of the apparatus. This discoid stopcock consists of two circular brass plates accurately fitted to one another, the inner of which is firmly soldered to the apparatus, and the outer one turns round a perforated pivot  $f$  about 5 centimetres long, 1 centimetre wide. Beside this pivot, which we may regard as an intermediate or respiration tube, there is a second somewhat shorter, equally wide lateral tube  $q$ . To the right and left of the central tube are the exit orifices of the tubes coming out of the cylinders. The outer rotatory as well as the inner firmly soldered disc are perforated in such a way that the two tubes  $f$  and  $q$  communicate with the one or the other cylinder according as the disc is rotated, the central tube  $f$  always communicating with that bell towards which it is turned, the lateral tube  $q$  with that bell to which it is brought next by the rotation. The rotation itself is best effected by laying hold of and turning the projecting lateral tube.

Upon the middle tube  $f$  an indiarubber tube  $r$ , of about 75 centimetres in length and 1 centimetre in width, is fixed, which is furnished at its anterior extremity with a sliding valve and mouthpiece and mask for the face, similar to what Schnitzler has described in his first respiratory apparatus.

The two cylinders are so connected together by chains  $g$ , running on two pulleys attached to the sides of the outer cylinder, that they always balance one another, in consequence of which one always rises as the other falls, and conversely. The cylinders rise and fall by means of conducting rods  $i$ , which are fitted to their side.

At the posterior part of the apparatus there is a winch  $k$ , by the aid of which two iron rods  $l$  fixed there, supporting above a dish  $m$  for the reception of the weights  $n$ , can not only be easily moved up and down, but also the dish with the weights can readily be transferred from one cylinder to the other. The dish for the weights consists of a circular iron plate some  $2\frac{1}{2}$

centimetres thick, weighing 5 kilogrammes, which is perforated in the centre and has a handle at the side. It is obviously convenient to have this dish and the weights of a circular form, to fit on the top of the cylinder. The weights are of cast iron and weigh 1 to 5 kilogrammes. The apparently great weight of the dish itself has the advantage that in cases where a very great weight is not desired the dish alone is capable of exercising a sufficient compression, thus making other weights unnecessary.

The following is the way of using the apparatus :—After the two cylinders are so connected by the chains passing over the rollers that one of them is at the bottom of the receiver, and the other at its highest point—that is, 65 centimetres above the former—the outer oval vessel is filled with water, but only somewhat over 65 centimetres high, in order, while the apparatus is in use, to prevent the entrance of the water into the air-tubes, so that the upper cylinder only brushes the surface of the water, so to speak, with its lower end.

The two stopcocks *o* at the foot of the water receiver, which during the filling of the apparatus were open, are now closed; the dish is then raised by means of the handle, and by means of a slight turn is put upon one of the two cylinders. The cylinder *B*, on which the dish is laid, will now sink, according to its weight; at the same time the other cylinder *C* will rise to an equal extent; thus the air will be condensed in the bell *B* and rarefied in *C*. We have thus condensed air in one bell and rarefied air in the other. A manometer also communicates with the bells by means of the discoid stopcock, and shows the degree of condensation relatively to the rarefaction of the air.

As already mentioned, the central tube, to which the respiration tube is attached, communicates, according to the position of the movable disc, with one or the other cylinder. Thus condensed or rarefied air can be used at pleasure for respiration.

If, for example, as in the accompanying drawing, the lateral tube *q* is turned to the bell *B* above, which carries the weights and so contains condensed air, the respiration tube communicates with the other bell *C* below, which contains rarefied air. In this position the apparatus is employed for expiration into rarefied air.

If now we turn the discoid cock  $180^\circ$ , the lateral bell is brought round to the bell C, containing rarefied air, and the central tube is turned to the bell B, containing condensed air, and thus the respiration tube communicates with the condensed air. In this position the apparatus is employed for inspiring condensed air.

By another turn of the discoid cock  $90^\circ$  the lateral tube is moved upwards, and the communication with the cylinders is entirely stopped, and the only communication is with the manometer, and then the apparatus can also serve as a pneumatometer.

The degree of concentration relative to rarefaction of the air can be reckoned in the same easy way as in Schnitzler's first apparatus, and, as he has also preserved the cylinders of the same dimensions (25·25 centimetres in diameter), we need only refer to what has been said above. Indeed the manometer in a measure relieves us of the trouble of reckoning.

The apparatus is used in the following manner:—

After the outer cylinder A has been filled to the height above stated with water, and the two cylinders B and C are placed in the manner described above, the dish *m*, with the necessary weights *n*, is laid on the upper cylinder B, and then, if it has not been done before, the discoid cock *e* placed in proper position, i.e. the central tube turned to that bell which is to be used for respiration.

If it is our object to make the patient inspire condensed air, the discoid cock is so turned that the central tube *f* appears turned towards the higher bell, loaded with weights (therefore not as in the preceding drawing, where the central tube communicates with the rarefied air), while the lateral tube *g* is turned towards the lower bell. Now the patient, who may stand or sit in front of the apparatus, takes the mouthpiece of the respiration tube *r* in his mouth, or else holds the mask as airtight as possible over mouth and nose, and when he presses down the slide *s* by means of pressure with the finger as low as possible the compressed air enters into the air passages with a pressure answering to the weighting of the bell. In the succeeding expiration into the surrounding atmosphere mouthpiece and mask may be removed each time, or else the slide may be

let go, when it flies up of itself and thus allows the respiratory organs to communicate with the surrounding atmosphere. But, as patients are seldom skilful enough to manage this second process, the first mode of procedure is preferable, i.e. to use mouthpiece or mask only during inspiration out of the bell, but to remove both in expiration into the surrounding atmosphere. The construction of the sliding valve, as well as the manner of using mouthpiece and mask for the face, and the precautionary measures to be adopted, have been already described.

As the compressed air enters into the lungs at every inspiration with a pressure corresponding to the weight of the bell, of course the bell sinks in proportion to the amount of escaped air. But in the same measure as the upper bell sinks the lower bell must rise, in consequence of their connection, while at the same time by means of the lateral tube it sucks in air out of the surrounding atmosphere, so that the bell *C* reaches the highest position at the moment the bell *B* reaches the bottom of the receiver. Ten to twenty respirations on an average suffice for this.

If now, the bell *B* having fallen to the lowest point, and *C* risen to the highest, the discoid cock is turned 180°, the central tube will again communicate with the bell above, the lateral tube with the bell below; and if by means of the winch *k* the dish with the weights is laid upon the upper bell, the patient can again inspire condensed air out of it till it sinks again to the ground and the other rises, whereupon the former procedure is repeated as often as the physician considers it necessary. With a little practice the turning of the discoid cock and the transferring of the dish with the weights from one cylinder to the other may be accomplished with great ease.

If we wish to make our patients expire into rarefied air, the discoid cock is so placed that the central tube *f* is turned to the lower cylinder containing rarefied air, while now the lateral tube *g* communicates with the cylinder above—exactly as in the preceding drawing. Now the patient, as before described, takes the mouthpiece *v* of the respiration tube *r* in his mouth, or places the mask *t* as airtight as possible before

mouth and nose, and, after he has pressed down the slide *s* by means of finger pressure, expires as strongly as possible; in the succeeding inspiration mouthpiece and mask can be removed each time, or else by letting go the slide—which flies up of itself—the communication of the respiratory organs with the surrounding atmosphere is restored. Here also it is more convenient to use mouthpiece and mask only during expiration into the rarefied air of the bell, and to remove them when breathing the outer air.

In each expiration into the rarefied air of the bell *c* the latter will suck the air out of the lung of the patient according to the degree of rarefaction. Meantime of course the bell rises up correspondingly to the amount of the expired air, but in the same proportion as the bell *c* rises the bell *b* will sink, while at the same time the air escapes through the lateral tube, so that the bell *b* reaches the bottom of the outer cylinder at the same moment that *c* has reached the highest point. Five to ten expirations are usually sufficient for this. If now the bell *b* is down and the bell *c* up, let the discoid cock be turned  $180^{\circ}$ ; the lower cylinder will again communicate with the central tube, the upper cylinder with the lateral tube, and now by means of the winch the dish with the weights is laid upon the upper bell and the patient can now again expire into the rarefied air, &c.

If we wish to make the patient each time, after he has inspired a bell full of condensed air, expire immediately into rarefied air, we only need, so soon as the cylinder has reached the bottom, to remove the weights from it to the other cylinder; the discoid cock must not of course be turned in this case, as now expiration is made into the same bell, out of which condensed air has just been inspired. But it is scarcely necessary to emphasise that the patient must not without changing the discoid cock inspire out of the same bell into which he has previously expired.

From this description—somewhat minute perhaps, but certainly not too diffuse for the right understanding of the subject—the mode of handling the apparatus must have been made so clear that it is unnecessary to enter into the various combinations that are here possible. It must, however, be kept

in view that the two tubes  $f$  and  $g$  communicate with those cylinders to which they are turned, and that in the employment of a flexible respiration tube it is the central tube into which that is fitted and which therefore forms the actual respiration tube of the apparatus.

The case is otherwise when the object is after each inspiration of condensed air to expire into rarefied air. For this purpose we must also attach to the lateral tube  $g$  a similar indiarubber pipe to that upon the central tube  $f$ , and connect the anterior orifices of the two flexible tubes with a double sliding valve constructed expressly for this object, inserting into the one indiarubber tube the tube  $y$  and into the other the tube  $z$  (v. fig. 27). By the play of the slide, i.e. by pressing it only half down or altogether, the patient can by means of the mouthpiece  $v-w$  with every inspiration out of the bell inspire condensed air, and with every expiration breathe out into the rarefied air of the lower bell.

Schnitzler found, however, that this double sliding valve is very seldom rightly used by patients; they very frequently breathe just the other way, inspiring rarefied and expiring into condensed air. For this reason, and still more because he feels justified in considering that this combined method is not only superfluous, but in many cases directly injurious, as patients can seldom well tolerate such fluctuations of pressure in the lung, Schnitzler has quite discarded this method, i.e. the inspiration of condensed with immediately succeeding expiration into rarefied air, and now only employs the method previously described.

The degree of condensation and rarefaction of the air in the two bells, as also the amount of inspired and expired air, may be calculated in a very simple manner.

The diameter of the cylinder in the apparatus is, as previously mentioned, 25.25 centimetres; from this it follows that their surface, according to the familiar formula, makes

$$r^2\pi (= 12.625 \times 12.625 \times 3.14 = 500.486),$$

in round numbers 500 cubic centimetres. Each centimetre which the bell rises or falls will therefore answer to a  $\pm$  volume of air of 500 cubic centimetres. Again, as the weight of an atmosphere upon a square centimetre is represented by 1033.



grammes, this gives in a surface of 500 cubic centimetres ( $=1033 \times 500 = 516$ ) in round numbers 500 kilogrammes. Thus the pressure of each kilogramme will produce  $\frac{1}{500}$  atmospheric pressure. As the dish itself, as previously mentioned, weighs 5 kilogrammes, it alone produces an increased pressure of  $\frac{1}{100}$  atmosphere, equal to 7.6 mm. mercury; each additional plate will, according to its weight, increase the pressure in the bell. As the two bells balance one another, the one which is not weighted will each time rise as the weighted one sinks, whereby the air in the former is always rarefied in the same degree as that in the other is condensed.

#### 6. *The Apparatus of Finkler and W. Kochs.*

Finkler and Kochs in Bonn have recently invented an apparently commodious apparatus, which unfortunately we have not yet ourselves had the opportunity of testing. The apparatus serves to force compressed air into the lung in inspiration, and to assist expiration by sucking the air out of the lung (fig. 28).

A cylinder of strong tinned zinc serves for the reception of the water. It is 25 centimetres wide; its bottom is pierced by the wide tubes  $r^1$  and  $r$ , of 1.5 internal diameter.

In this cylinder is placed a double bell hung by means of a chain wheel and balanced by weights.

The inner bell is 35 centimetres high and 16 centimetres wide.

The outer bell surrounds the inner like a ring; it is 70 centimetres high and 40 centimetres wide.

The bells are made of far thinner zinc than the cylinder.

Upon the inner bell is fixed the tube  $k$ , with valve working inwards, while the tube  $r$  leads out of the bell towards the mask for the face.

Upon the tubes  $r$  and  $r^1$  two indiarubber tubes are fixed which are connected with the facial mask by a T-shaped piece. By means of a double holdfast pressure of the hand will close one of the tubes, while the other opens.

The apparatus is filled with water by means of the inlet  $n$ , which is then firmly closed by means of an indiarubber

stopper. The chain wheel consists of two concentric wheels with the same axle. The innermost is connected with the bell, the outer one with the counter-weight.

The radius of the outer wheel is double that of the inner,

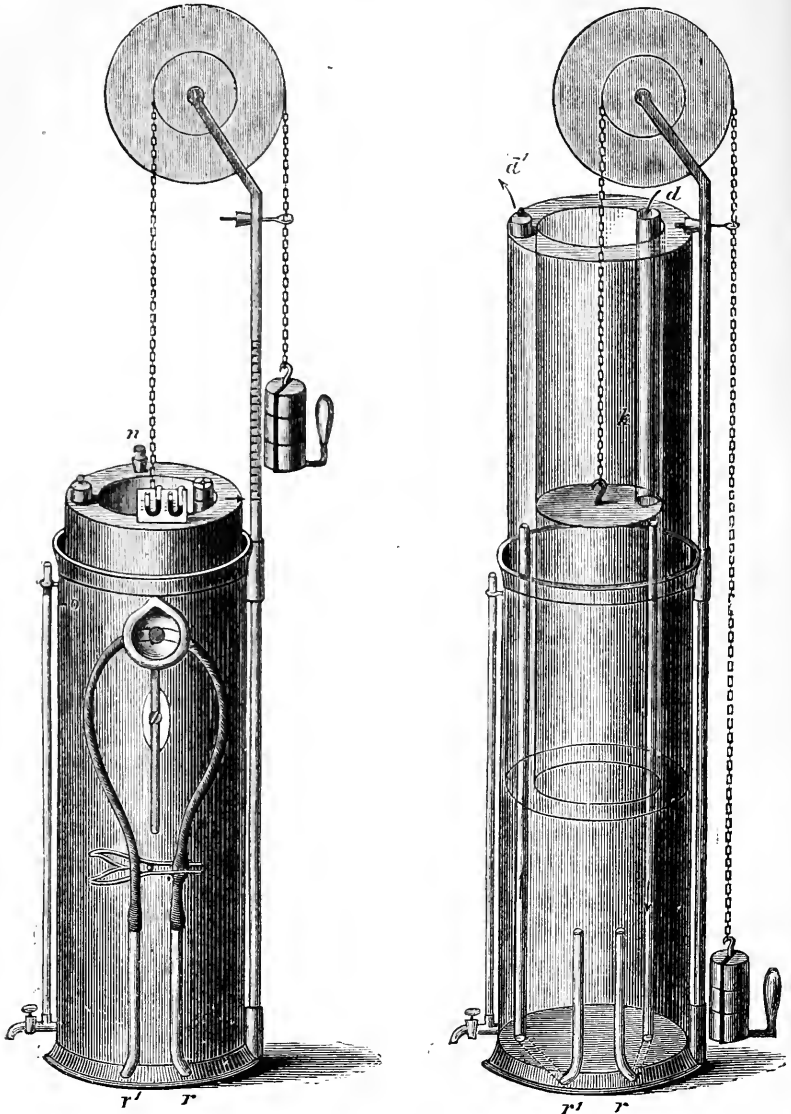

FIG. 28.

so that the counter-weight only needs to be equal to half the weight of the double bell.

If the counter-weight be loaded by laying on more weights, the double bell is lifted up. At the same time the valve  $d$  closes and the valve  $d^1$  opens. If now at the same time the indiarubber tube upon  $r$ , which leads from the inner cylinder to the mask, is compressed, and thus the tube on  $r^1$  opened, which leads from the outer cylinder to the mask, the outer bell sucks air out of the mask (i.e. the lung), and the inner bell fills through its open valve  $d$  with air from the surrounding atmosphere.

If now the counter-weight is lifted up by the handle, the double bell falls down by its own weight. If we now open the flexible tube at  $r$  and close the one at  $r^1$ , the air out of the inner bell is forced through the flexible tube in the face mask (i.e. the lung). The outer bell, on the other hand, lets its air escape through the open valve  $d^1$  into the atmosphere.

As the double bell sinks down the inner bell  $b$  pours into the mask (i.e. lung) through the tube  $r$  the air which it had previously sucked in through the valve  $d$  from the atmosphere, while the outer bell  $c$  discharges through valve  $d^1$  the air previously sucked in through tube  $r$  out of the mask (i.e. the lung).

The degree of rarefaction and of compression may be varied by altering the counter-weight and altering the weight of the double bell by laying on lead plates. These variations are empirically determined and multiplied by the weight belonging to the apparatus, and so measured that a suction power of  $-2$  centimetres mercury and a compression power of  $+2$  centimetres mercury can be obtained.

The open mercury manometer affixed to each bell shows the then existing pressure in the inner or outer bell.

The counter-weight is so measured that it draws up the bell with the loaded weight with the requisite suction power, while by the counter-weight being lifted so as to relax the chain the weighted bells sink down with sufficient force. The maximum of the counter-weight to be raised is about 5 kilogrammes.

The maximum of the distance which the counter-weight travels amounts to 70 centimetres.

Outside the cylinder are a tube to show the water-level and

the outlet cock. The valves are circular indiarubber discs 3 centimetres in diameter.

If the apparatus is to be used as a spirometer for the measurement of the amount of air expirable after the strongest inspiration, the valves are withdrawn and the orifices closed by indiarubber stoppers.

If, while the mask communicates with tube  $r^1$ , an expiration is made and then the flexible tube closed, it is only necessary to so raise the counter-weight that the manometer of the outer bell stands at 0, and then the amount of the expired air can be read off directly in cubic centimetres on the scale fixed to the rod accurately up to 50 centimetres.

### (C) APPARATUS CONSTRUCTED ON THE BELLOWS PRINCIPLE.

#### 1. *Biedert's Apparatus.*

Biedert has departed from the gasometer principle introduced by Waldenburg in the construction of pneumatic apparatus, and, in order to make the price as low as possible, has constructed a new, very moderately priced apparatus on the principle of the bellows or the accordion (*Zieh-Harmonica*), which combines constant pressure and continuous action.

Not only on account of the moderate price, but also for the sake of greater handiness, the bellows containing the respiratory air is only large enough to hold the maximum of air necessary for one inspiration, so that at every inspiration it has to be filled afresh. Biedert, like Waldenburg, considers a capacity of 9000 cubic centimetres as the smallest amount necessary as well for the inspiration of compressed air as for expiration into rarefied air. But, as it is desirable to be able to command a certain excess, first because a patient might require somewhat more, and some air is always lost in the application, and also because in the utmost limits of compression or dilatation the resistance of the mass or elasticity of the bellows produces an experimentally determinable, though very slight diminution of the pressure or suction up to two to three millimetres mercury, which is avoided by the excess, Biedert has fixed the

<sup>1</sup> A similar apparatus has been constructed by Dr. Bayer; it may be obtained of Léon Denis, Brussels.

capacity of the bellows at 15700 cubic centimetres, of which, however, only 14000 are available, as the bellows can only be compressed four to five centimetres, and therefore 1700 cubic centimetres are lost.

The bellows itself is cylindrical in shape, 50 centimetres high, 22 centimetres wide, having above and below a wooden lid  $1\frac{1}{2}$  centimetre thick ( $a$  and  $a'$ , fig. 29), and walls composed of leather, made airtight by gumming, and strengthened by an inner lining of paste-board, so that it retains its form under the necessary excess of atmospheric pressure. The lower lid ( $a$ , fig. 29) is perforated near its anterior edge by an indiarubber tube, which is inserted airtight and kept patent by a spiral wire. The upper lid ( $a$ , fig. 29) bears two crossed straps for buckling on the weights, and laterally two iron pins to prevent their slipping to the side.

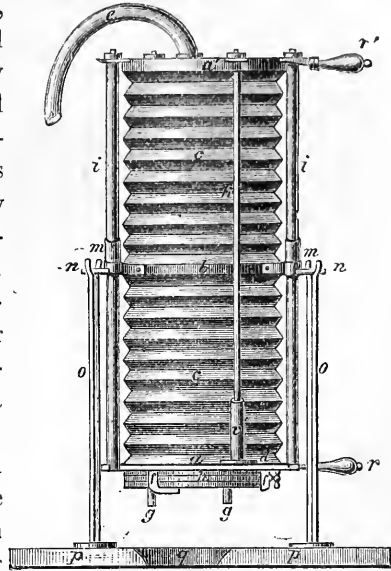

FIG. 29 (position I.)

The second part of the apparatus is an iron frame, consisting of two round iron rods standing opposite to one another on each side, the thicker ones = 1.8 centimetre ( $i$ ) and the thinner = 1 centimetre ( $k$ ), which are riveted above into a flat ring 24 centimetres in diameter. At the lower end of the rods ( $a'$ , fig. 29) the floor of the bellows is screwed on by means of projecting ears, and can at pleasure be taken out and replaced by another.

The upper lid  $a$  can be moved along the frame by means of two gliding tubes  $v$  which embrace the rods  $k$ . For their support when more heavily weighted there are yet two other tubes  $m$  which slide on the thick outer rods; from the middle of these rods project outwards two iron pins, the axes  $n$ , by means of which the bellows is made to rest on two iron

supports about 37 centimetres high (*oo*), which are let into a broad wooden stand *p*; and it can be turned on these supports by means of two handles (*r* and *r'*), one of which (*r*) proceeds above from the ring, and the other (*r'*) below from the lateral bar in the direction of the transverse diameter, but somewhat in front of it. Thus the apparatus admits of a half-rotation backwards, till the handle strikes against the support. Two handles are more convenient, because the turning can thus be managed in every position by a pressure downwards—a necessary relief when the weighting is great.

5 flat leaden weights of 5 lbs. and 2 of 2·5 lbs. are added to the apparatus. The condensation and rarefaction in the new apparatus, somewhat modified as to the thickness of the material, gives with a  $\pm$  weighting the following values:—

Lbs.	Atmospheric Pressure =	Mercury, Millimetres
2·5	$\frac{1}{14\frac{1}{2}}$	5
5·0	$\frac{1}{29}$	8
10·0	$\frac{1}{54}$	14
20·0	$\frac{1}{29}$	26
30·0	$\frac{1}{20}$	38

It is best to begin with 5 lbs. and rise gradually by 2·5 lbs.

The respiration tube possesses a mouthpiece or a respiratory mask; a respiratory valve, like that employed by Schnitzler, formerly a stopcock, is only supplied on demand and can easily be inserted into the respiration tube; without this mechanical contrivance the respiration tube is simply compressed and relaxed alternately by the fingers. For simultaneous inhalations of volatile medicinal agents there is a glass cylinder (*Medicamenten-Köcher*), furnished above and below with a metal casing, in which a sponge in a tinned wire cage is laid for the reception of the medicinal substances. The air passing over it is impregnated with the vapours of the medicine which is thus inhaled.

#### *Mode of Application.*

The apparatus is placed in an upright position on the edge of a table, with the flexible tube in front lying in the notch (*q*) in the wooden floor, and the necessary weight is laid upon it.

If compressed air is to be inspired, the upper part of the apparatus is turned downwards (position I. fig. 29), the weight sinks, and the bellow fills with air. Now it is turned back again, while the patient, standing in front, compresses the tube between his fingers, or perhaps shuts off the stopcock, till he can begin his inspiration through the mouthpiece of the indiarubber tube, through which he draws in air evenly compressed by the sinking weight up to the end (fig. 30, II.) While the patient expires into the open air, the bellows is again filled by turning, and resumes its activity when the apparatus is turned back again, and so on.

Expiration into rarefied air, on the other hand, is carried out

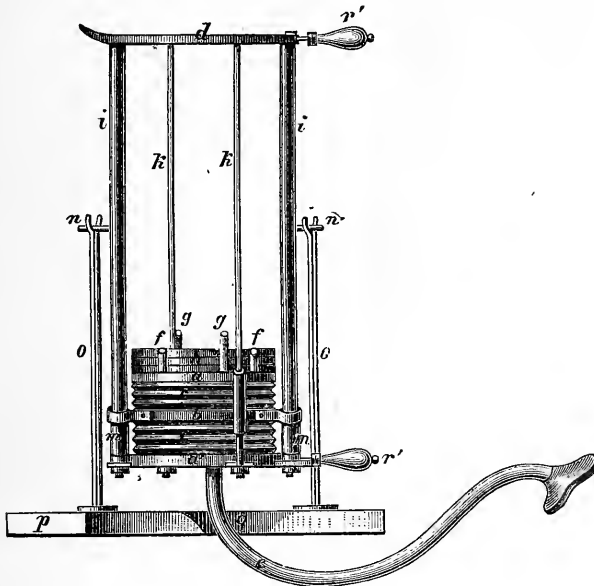

FIG. 30 (position II.)

by turning round the apparatus from the position II. (fig. 30) into the position I. (fig. 29), while the patient by compressing the tube or by means of the stopcock prevents the entrance of air till he can begin his expiration, which then takes place also in consequence of the steady sinking of the weight, into continuously equally rarefied air. By inversion the bellows filled with expiratory air is now again emptied, while the patient

himself inspires out of ordinary air; then follows the next expiration, and so on.

Lastly, alternating respiration can be carried out by Biedert's apparatus in this manner:—The bellows for the inspiration of compressed air is not completely filled, in order that after the inversion of the apparatus in the immediately succeeding expiration into rarefied air space should still be left for a residue of expiratory air. In this it will be well, after each or at least after every second inspiration, to empty the apparatus now filled with condensed air, before the inspirations are renewed, so that the patient after each respiration out of the

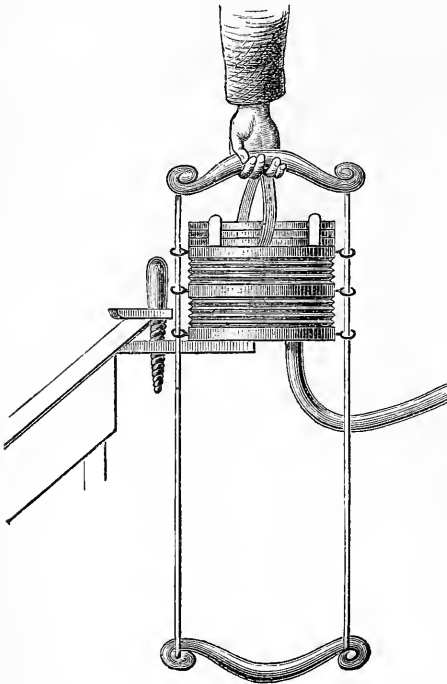

FIG. 31.

apparatus shall take a breath in atmospheric air. Biedert is of opinion that a more complete inflation followed by a more perfect emptying of the lungs is obtained, even though a respiration in ordinary air intervenes, but that, on the other hand, we must not look for an influence on the vascular system from this procedure, on account of the directly opposite action of the compressed and rarefied air. (Cf. here the Double-ventilator of Geigel and Mayr, p. 417). In this way the apparatus would still

serve the purpose of those physicians who attach special importance to the alternating method. Biedert's suggestion that his apparatus might also serve as a spirometer cannot be maintained, as in the construction of the apparatus the friction coefficient weighs too heavily in the scale against the



expiratory pressure necessary to obtain even approximately available figures. On the other hand another modification which Biedert has proposed may be reasonably accepted—namely, in case we are unable to procure an apparatus of the desirable accuracy, we should use the bellows only (figs. 31 and 32). For this purpose the bellows, when, for instance, compressed air is to be inspired, is screwed on to the edge of a table by means of an iron clamp in the lower lid and

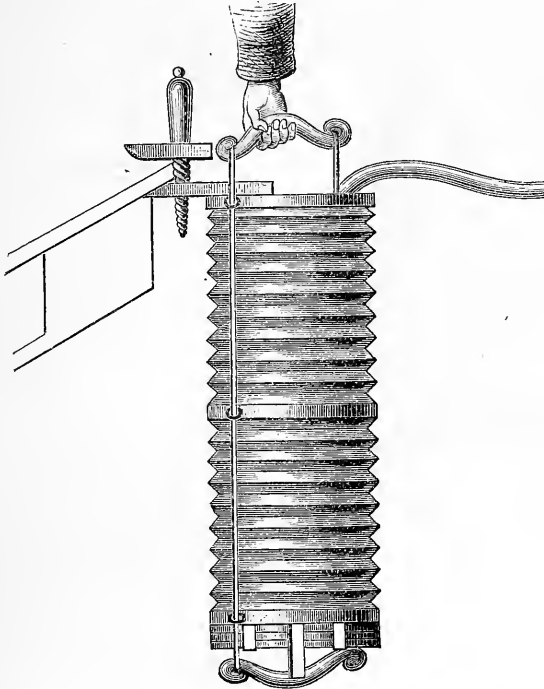

FIG. 32

the weights strapped on above ; an assistant opens the bellows by drawing up the weights, and holds it by a handle, that it may not collapse. By reversal of the attachment and suspension of the weights, the air is rarefied by the traction, and expiration into rarefied air can take place. The price of a complete Biedert's apparatus is about 42 marks ; the bellows alone can be had for 20 marks.

### 2. B. Fränkel's Apparatus.

The excessively cheap apparatus of B. Fränkel remains to be mentioned; it is on the principle of the accordion (*Zieh-Harmonika*), and although it does not fully answer to all the demands of pneumatic therapeutics, yet, as Waldenburg and Biedert have pointed out, it may prove very serviceable in many cases.

The apparatus (fig. 33) consists simply of the bellows of an accordion, on one side of which is placed a tube, 2 centimetres wide in diameter, which has for a mouthpiece an inflated indiarubber cushion, such as are employed as pessaries. The patient himself draws out and compresses the apparatus, accordingly as he wishes to expire into rarefied or inspire compressed air, during which process a weighted centimetre measure at its free end enables him to read off by how many centimetres the side walls are drawn asunder or brought near to one another. As the apparatus is



FIG. 33.

35 centimetres high and 16 centimetres broad, its distension or contraction by 1 centimetre answers to a volume of air of 510 cubic centimetres; hence, when the number of centimetres by which the apparatus is distended or compressed is multiplied by 510, the result is the volume of air inspired or expired each time. The amount of pressure to be obtained by the greatest strain of the apparatus reaches to about  $\frac{1}{18}$  atmosphere positive pressure, and admits a rarefaction of about  $\frac{1}{20}$  atmosphere, while a moderate exertion of force, such as an average application and the strength of the patient permit, effects a  $\pm$  pressure of about  $\frac{1}{70}$  to  $\frac{1}{50}$  atmosphere. As a rule Fränkel does not consider it necessary to dictate to

the patient how far he is to distend or compress his apparatus, as the patient can regulate the necessary pressure best according to his subjective feelings, and thus acquires the management more easily.

The defects of an apparatus of this construction are obvious; besides the inaccuracy in the amount of pressure and the inconstancy of its operation, the action of the pneumatic treatment is also interfered with by the fact that in the actual manipulation of the bellows the patient has to assume a stooping posture, as Fränkel prescribes, one most unfavourable to full expansion of the thorax and to free pulmonary ventilation. The apparatus has been frequently and successfully used as a means of employing artificial respiration in asphyxia; on account of its extremely compendious shape and the rapidity with which it can be set to work, it seems to be specially adapted for these and other disturbances of the respiratory functions.

(D) APPARATUS ON THE WATER-ENGINE BELLOWS PRINCIPLE.

*The Double Ventilator of A. Geigel and A. Mayr.*

Geigel and Mayr, of Würzburg, have constructed a pneumatic apparatus which without loss of time or previous preparation yields any requisite degree of condensation or rarefaction of air, maintains it at a constant height and in continuous force for an unlimited period, and at the same time admits of variation of these amounts of pressure by dilatation and contraction, and thus enables the patient to pass by gentle transitions into and out of the abnormal respiratory conditions to which he is subjected. By the simultaneous use of two apparatus, which are placed in communication with the mouth of the patient by means of two flexible breathing tubes and a double respiratory valve, and by maintaining the properties indicated with regard to constancy and continuity, a simultaneous rarefaction and condensation of the air can be established, which enable the patient to inspire compressed and expire into rarefied air by one and the same respiratory act.

*Principle.*—The following schematic representation (Geigel) gives the best idea of the mechanical principle on which

Geigel's apparatus is based, the *water-engine bellows* (*Schöpf-radgeblüse*), formerly largely used for technical purposes, now become obsolete :—

Imagine a box, or, as we prefer to call it, a mantle of sheet iron hermetically closed, of a similar shape to the somewhat flat-pressed glasses with which clock faces are covered, indicated in the schematic section of fig. 34 by the boundary line M, M r, M. The inner space of this mantle, the mantle space, communicates by the aperture of the mantle and the short tube affixed to it, the mantle tube M r, freely with the open air.

Next suppose a vertical wheel, the many-chambered wheel,

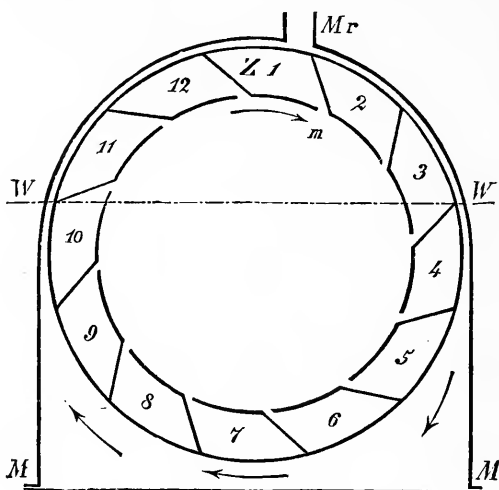

FIG. 34.

which is represented in fig. 34 by the inscribed circle. The horizontal axle of this many-chambered wheel is placed in the centre of the anterior surface of the mantle, and can be easily turned by means of a toothed wheel and winch. Axle, spokes, toothed wheel, and winch are omitted in the merely schematic drawings of figs. 34 and 35.

This wheel, which is also made of strong sheet iron, possesses on its inner, concave side, therefore directed towards the middle of the mantle space, empty chambers, closed on all sides (fig. 34, z 1 to 12), which, if we suppose the wheel turned in the direction of the arrows, possess only at their anterior and inner corner a slit-like aperture, the mouth of the chamber (fig. 34,

at *m* mouth of the chamber 1). Through this aperture therefore the enclosed space of each several chamber communicates with the general inner space of the mantle.

If now the latter is filled with water through the mantle tube *M r* as far as the line *w w* and the many-chambered wheel turned in the direction indicated, the chambers still filled with air—3, 2, 1, 12, &c.—will one after the other dip under water. The air contained in each several submerged chamber will thus be somewhat compressed by the water entering by the mouth of the chamber and transported so far, till in the advancing rotation of the wheel it escapes from the mouth of the chamber now directed upwards, and rises up vertically in bubbles over the surface of the water. It is easily seen from the schematic drawing that this escape of air begins, continues, and ends each time that each several chamber passes the place occupied in fig. 34 by the chambers 5, 6, 7, 8. Of course the chambers draw in water in like proportion, which they push forward to the other side or raise till the mouth of the chamber again begins to be directed downwards, therefore somewhat about the height of chamber 11, in which case the water begins to flow out, so that having at length reached the level of chamber 2, each chamber is again filled with air out of the mantle space, and now, again dipping under water at the level of chamber 3, the whole action we have described is renewed.

Now imagine an iron bell introduced into the flat cylindrical space encircled by the many-chambered wheel within the general mantle space.

This has two orifices, a lower wide one (*G G* in fig. 35), which dips deep under the water line, and an upper narrow one, which passes through the mantle wall and is prolonged into the short bell tube *G r*. Of course the upper part of the bell must be so constructed as to shape that the many-chambered wheel may rotate beside it unimpeded in the interior of the mantle space without interfering with the inner space of the bell itself, the bell space. On the contrary, it is clearly seen in the drawing that this bell space, so far as it is still filled with air above the original water line *w w*, is now completely isolated by means of the wall of the bell and water from the remaining air-filled portion of the mantle space.

While thus, as schematically expressed, the many-chambered wheel can rotate freely near the upper tubular orifice of the bell, its rotations are also unimpeded at the lower orifice of the bell  $GG$ , as its margin only approaches close to the many-chambered wheel, without touching it; but, as is seen, it projects far into the many-chambered wheel, so that the lower orifice of the bell  $GG$  is always over the lowest chambers.

If now the many-chambered wheel, as previously described, is set in motion, the chambers filled with air, 3, 2, 1, &c., will successively pass the lower orifice of the bell  $GG$ , and here allow their air to escape into the bell. If we now close the upper

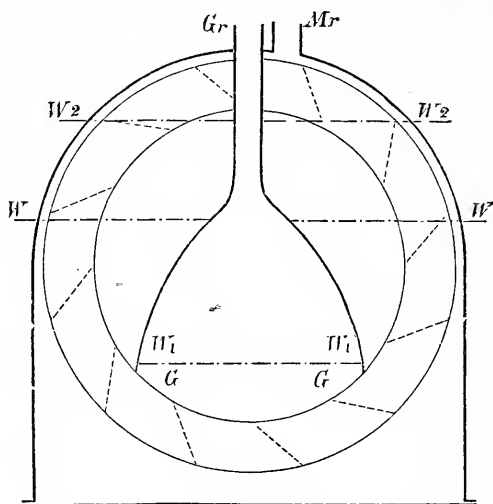

FIG. 35.

orifice of the bell  $G_r$ , the air of the chambers, as the wheel continues to rotate, accumulates more and more in the bell space. Hereby the water within it, which originally reached as far as the water line  $w w$ , is forced through the orifice of the bell  $GG$  and runs over into the mantle space.

When in this manner with the increasing volume of air in the bell space the water level in it must sink, for example, to the line  $w_1 w_1$  in fig. 35, the water level in the mantle space, on the other hand, rises at the same time proportionally to the quantity of water forced out of the bell as far as the line  $w_2 w_2$ .

The difference thus produced in the height of the two

water levels gives directly the atmospheric pressure which weighs upon the air in the bell space, or the measure of the tension which it suffers from a column of water whose height is equal to that difference.

If now the bell tube  $Gr$  is opened, the air here streams out under this tension. As, however, owing to adequate rotatory swiftness of the many-chambered wheel, an equal amount of air is always supplied from below to the bell space to that which streams out above, therefore the pressure of air in the bell, in spite of the narrow bell tube remaining open, may be constantly maintained at the requisite height.

If, on the other hand, the orifice  $Mr$  of the mantle space is closed, while from the first the bell orifice  $Gr$  remains open, then by turning the many-chambered wheel in the direction indicated the air within the mantle space is generally withdrawn and transferred into the bell space. Thus a rarefaction of air takes place in the mantle space, by which the water level in it is raised by suction, while it falls in the bell. The amount of the rarefaction, like that of the previous compression, corresponds to the difference of the height of the two water levels.

Analogously to the former process, this rarefaction remains constant if the rotatory swiftness of the many-chambered wheel, and with it the amount of air withdrawn by the chambers from the mantle space, correspond to the amount of air constantly streaming in afresh through  $Mr$ .

*Action of the Bellows.*—In adapting the principle thus theoretically established of the water-engine bellows to special therapeutic purposes, Geigel thought it necessary to make two large general claims upon the efficiency of the new apparatus.

In the first place, without detriment to the moderate dimensions of the apparatus, it must be capable of modifying tension at pleasure in the positive and negative sense up to  $\frac{1}{10}$  atmosphere; in the second place, a sufficient amount of condensed and rarefied air must be available every time, so that even the extreme limits of an abnormally great lung capacity or the simultaneous respirations of two patients should produce but very slight variations in the constancy and continuity of the pressure of air obtained.

The establishment of these two claims sufficed to fix the exact proportions of the new apparatus; as to the desired height of air tension, its efficiency depends on the internal diameter of the many-chambered ring or the height up to which the difference of the water levels in bell and mantle space could be driven; and as to the available amount of air, it of course depends on the cubic capacity of the chambers and the rotatory swiftness of the wheel.

In order, therefore, in the first place to be able to obtain the postulated extreme amount of air tension in the positive and negative sense up to  $\frac{1}{20}$  atmosphere pressure, the dimensions of the water-engine bellows adapted for pneumatic purposes, and especially the internal diameter of its many-chambered ring, must be so proportioned that the difference of the water levels in the bell and mantle space can attain a maximum height of 415 mm. With such dimensions it became possible to obtain in the bellows any desirable tension in the positive and negative sense between  $\frac{1}{20}$  plus pressure and  $\frac{1}{20}$  minus pressure, according to the degree of difference of the water levels produced by the rotation of the water engine.

But secondly, in order that the postulated maximum of the quantity of air which is to be available at any moment should also be obtained of the required tension, and that these tensions should be rightly utilised pneumatically, it was necessary first of all to fix the correct form and size of the chambers of the wheel. Upon this also depended the necessary degree of rotatory swiftness.

With regard to the form of the chambers, which in the first models were 12, but afterwards were increased to 15, care had to be taken that they should be of the form best suited to ensure as completely as possible their receiving and discharging air and water in the course of their rotations, so that no flaw in this respect should diminish the efficiency of the apparatus.

By calculations and experiments it was ascertained that this purpose is fully attained by that form of the several chambers in which they stand with their anterior walls tangentially to a circle concentric with the chambered wheel, the diameter of which  $D$  is =  $1.04H$ ,  $H$  indicating the greatest difference of the two water levels. In fig. 36, for example, the anterior



walls of 5 chambers are prolonged by dotted lines, till they meet tangentially the dotted circle of diameter  $D=1.04H$  concentric with the chambered wheel.

As a result of this arrangement the escape of air out of the submerged chambers begins at an angle of inclination of  $40^\circ$  to the surface of the water—i.e. just at the moment, as at  $a$  in fig. 36, in which the radius of the orifice of the chamber so cuts the horizontal surface of the water as to form the angle  $a=40^\circ$ .

Here the chambers successively take up a position below the bell, which makes all loss of air impossible, as in their

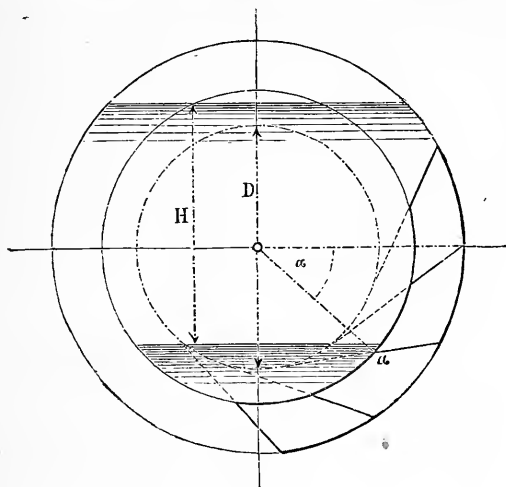

FIG. 36.

course along the lower orifice of the bell all air must escape from the chambers and, rising immediately above the water surface, necessarily accumulate in the bell space. Conversely the chambers discharge the water which they have drawn in, beginning at the same angle, in the mantle space to the last drop, so that, completely refilled with air from this space, they may again dip under water.

The chambers being thus formally arranged, their size, and therefore the capacity for a definite amount of air, is expressed by the following proportions:—Since the 15 chambers mounted upon the wheel form together a hollow ring of 0.72 metre of

internal, 0.93 metre external diameter, and 0.15 metre high, its cubic capacity will amount to

$$\frac{3.14 (0.93^2 - 0.72^2)}{4} 0.15 = 0.0408 \text{ cubic centimetre.}$$

If we deduct from this the capacity of the walls of the chambers, as well as that of their apices, which fill with water as they dip under up to the height of the posterior lip of the mouth of the chambers, there remains an effective demand for about 34 litres of air at every rotation of the wheel. Direct controlling experiments which Geigel and Mayr instituted with the help of a spirometer have shown that this calculation is approximately correct, but only the quantity of 32 litres has been actually obtained. We will therefore fix upon the latter number as the real measure of the quantity of air which is discharged into the bell by one rotation of the wheel.

Since the numerical ratio between wheel and impelling force, between winch and axle of the wheel is = 10, since therefore 10 turns of the winch answer to one whole rotation of the chambered wheel, then with every turn of the winch a quantity of air of  $\frac{3.2}{10} = 3.2$  litres is delivered.

If, then, we wish to effect in the minute only 2 complete rotations of the wheel or 20 turns of the winch, then the amount of air of the required tension yielded by the apparatus in each second would amount to over 1 litre, a quantity which is more than sufficient for the ordinary purposes of pulmonary therapeutics, and which may, each time it is necessary, be increased by accelerating the rapidity of the rotation.

No doubt this acceleration finds its natural limit in the circumstance that the several chambers require a certain time—short indeed, but still appreciable—to discharge their contents of water or air. If, therefore, the rotatory swiftness of the wheel is accelerated to such a degree that the evacuation cannot be thoroughly effected, then its highest efficiency will have been exceeded. It may be assumed that this greatest effect is obtained when the winch revolves thirty times, and therefore the chambered wheel three times, in the minute.

In this maximum degree of activity the apparatus furnishes 96,000 cubic centimetres of air in the minute. But a man

with the exceptional capacity of 5,000 cubic centimetres would consume only 80,000 if he were to make sixteen inspirations in the minute, which practically he cannot do, as in such deep breathing he would make at most 8 to 10 inspirations; therefore he could consume only 40,000 to 50,000 cubic centimetres. People with so remarkable a vital capacity would scarcely require pneumatic treatment. As a matter of fact, from 14,000 to 30,000 cubic centimetres in the minute, with a plus pressure of 10 to 15 centimetres, have been on an average sufficient for various patients hitherto.

The mechanical energy which is necessary for this degree of activity, specially for three rotations of the wheel in the minute with highest tension, is reckoned at 0·6 metre kilogramme. Taking into account the pivots, boxes, and friction of the teeth, it rises to 1·2 metre kilogramme. This is equivalent to saying that on the one hand the mechanical energy, the application of force, which we require to set winch and toothed wheel in motion, and thus to set the apparatus going, is a vanishing fraction, and that on the other hand, by this slight expenditure of force, far more air can be obtained than even the largest lung capacity requires in the same time.

Corresponding to these demands and to the structural form of the inner parts of the chambered wheel with the axle and the bell, it was necessary finally that the body of the apparatus should be 1 metre high, 0·97 metre broad, and 0·27 metre deep, dimensions which demand a very modest space, the more so that the apparatus can be most commodiously placed with its broad back directly against the wall, and that it has no thin, projecting, fragile or pliant parts, such as belong to the gasometer apparatus.

*Equipment.*—The water-engine bellows, thus adapted and proportioned to pneumatic purposes, externally furnished with the necessary indication figures, internally having all its surfaces overlaid with a coating of hard oil varnish and iron ochre, must now, in order to be qualified for its special function, be furnished at its periphery with a complete equipment, and therefore possesses, in addition to the axle with toothed wheel and winch projecting out of their box on the broad anterior surface, also various other small and short appendages.

In the first place, at the summit of the convex periphery is a short tube with a stopcock (fig. 37, *m'*), through which the apparatus is filled with water—150 litres in round numbers—and when the filling is complete this is known by the water begin-

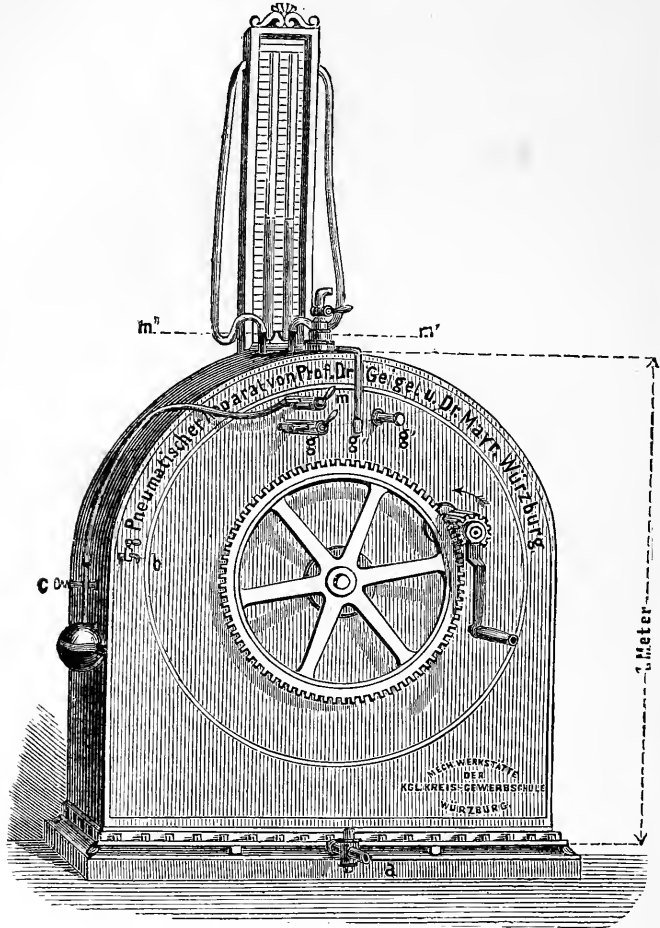

FIG. 37.

ning to flow out at a small cock *b* which is placed at the original water level. When this occurs the cock *b* is closed, and the filling is complete for many days. Provision is made for the occasional renewal of the water by an outflow cock *d* in the lower part of the apparatus.

By a simple arrangement the above-mentioned inflow tube, which is in close communication with the mantle space, may be conveniently used for the admission of fresh air from without.

While the rarefaction of air is being produced in the mantle space the inflow tube must remain closed under all circumstances like the mantle valve itself. For this purpose a short metal pipe is affixed to the inflow tube by means of a screw, and this is bent horizontally downwards, and can be closed by a stopcock, the conducting or inflow cock *m'*. Thus the communication of the mantle space with the external air of the room or with the inflow tube can be established or arrested by one single action of the hand.

In the vicinity of our inflow tube two simple, thin and short tubular appendages also proceed from the top of the apparatus (fig. 37, *g''*, *m''*), which serve to secure the indiarubber tubes by means of which the apparatus is connected with the manometer to be described further on. One of these tubes communicates with the mantle space, the other with the bell space.

*Bell and Mantle Valve.*—Whereas, in the schematic representation, for the sake of clearness, bell tube and mantle tube have their apertures at the highest point, these apertures in practical application are placed in the anterior surface of the apparatus (fig. 37, *g* and *m*), and furnished with a triple stopcock, designated bell and mantle valve. The two valves are so constructed that in case of need two respiratory flexible tubes may be fastened to each of them, which may be made use of at the same time by two patients, while by the triple stopcock it is not only possible to place the two flexible tubes at the same time rapidly in communication with the inner space of the bellows, or on the other hand to shut them off, but also to open and close at pleasure the communication of one of the flexible tubes with its corresponding air space in the apparatus, while the other remains quite inert, therefore permanently closed. For in by far the greater number of cases only one patient at a time will be treated, and thus the other, the reserve tube, as it may be called, will be superfluous. Lastly, the valve forms at the same time a regulator, by means of which the bell space, or the mantle space, can be made wholly or partially to communicate in all degrees with the open air, or be entirely cut off.

Fig. 38 represents the triple stopcock which is screwed on to the bell or mantle valve. HR is the posterior, VR the anterior flexible tube. The iron hollow cone K contains the stopcock bolt, which can be rotated by means of a handle. The

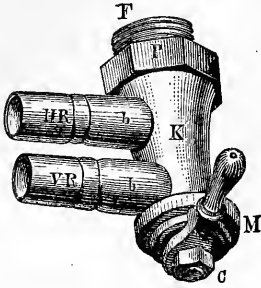

FIG. 38.

stopcock bolt has two perforations, answering to the orifices of the tubes. But the perforations of the stopcock bolt and those of the plugs are only exactly alike in size in the case of the anterior tube, while in the posterior tube the perforation of the stopcock bolt is double the length of that of the box. By this arrangement either both tubes can be opened or closed, or the anterior tube

can be placed altogether out of action while the opening and closing action of the posterior tube remains undisturbed. Fig. 39 represents these conditions more clearly.

Finally, by means of the anterior tube, the sum of two whole transverse sections of the two tubes still present in the

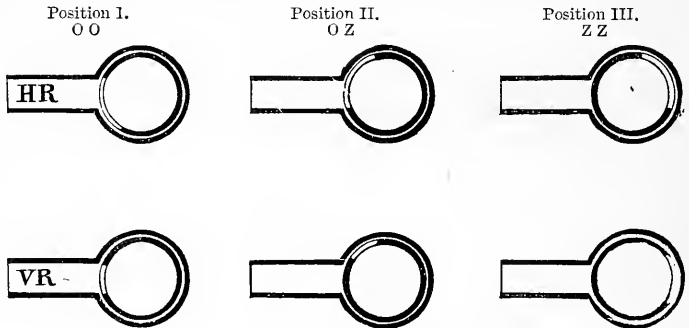

FIG. 39.

first section can, in the course of the passage from the first to the second position for the entrance or egress of air through the valve, be reduced in all gradations to one transverse section, or conversely, in the course of the passage from the third to the first position, the transition from zero to one or the whole transverse sections may in the same way be extended and regulated at pleasure. Geigel therefore designates the anterior tube the *regulating tube*, or the whole double cock the *regulation cock* of the bell and mantle valve.

Small pairs of letters, engraved on the margin of the metallic disc of the bell and mantle valve, show, when the handle of the stopcock stands between them, whether both tubes or arms of the valve stand open (o o) = position I., or whether only one arm—namely, the posterior—stands open, while the anterior is closed (o z) = position II., or whether both are closed (z z) = position III. Besides these two valves there is yet a third (fig. 37, *g'*), consisting of two cylindrical metal cases capable of rotating one over the other, and fitting to the bell space, which as reserve valve serves, while rarefaction of air is proceeding continuously in the mantle space, during which the communication of the bell space with the external air through the bell valve remains uninterrupted, to keep up this communication even more freely. In the opposite case, when condensation of air is going on, this valve of course remains closed, like the bell valve. Fig. 40 represents the valve, I. and II. in open and closed section.

Two indiarubber tubes are placed in communication with the bell and mantle valve, of which, when only one patient

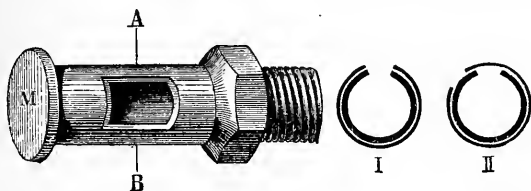

FIG. 40.

uses the apparatus, only the posterior comes into use and leads to the respiratory valve with mouthpiece and face mask. In this way one tube is also kept ready and distinct for inspiration and expiration.

*Respiratory Valve.*—In the inspiration of compressed or expiration into rarefied air, either each separately or intermittently, an ordinary respiratory valve, of similar construction to that supplied with Schnitzler's apparatus, is inserted into the flexible tube between the mask and the bell or mantle valve. For the simultaneous utilisation of the space disposable for compression and rarefaction of the air, Geigel has provided a new valve, which by simple manipulation on the part of the patient enables him to inspire the compressed air out of the bell space

of the water-engine ventilator, and then expire into the mantle space of a second apparatus filled with rarefied air.

The body of this valve (figs. 41 and 42) consists of a cylindrical stopcock, into the frame of which *g* the mask tube *m* and the two flexible tubes *r*, *r'* are inserted. The stopcock bolt *b*, fixed in the frame, has a perforation or aperture right through, which

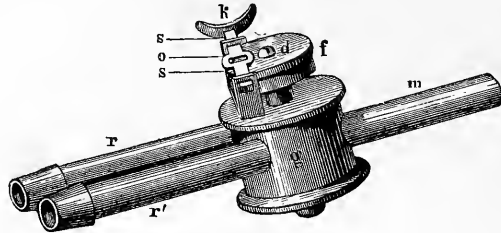

FIG. 41.

is twice as wide at the side turned towards the mask tube as at the other, which communicates with the flexible tube. It is readily seen in the schematic figure 42 that, in consequence of this conical form of the canal pierced by the bolt, one or the other tube alternately can be placed in communication with the mask tube by means of a quarter rotation of the bolt.

Now the axis of rotation of the stopcock bolt is firmly combined with the lid *d*, the spring cylinder *f*, and the loose

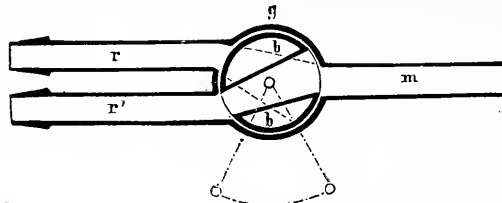

FIG. 42.

end of a spiral steel spring which is enclosed and rolled up within that spring cylinder. Laterally above the lid there lies in a stirrup fastened upon the box of the cylinder a slide *s*, whose slide-like orifice *o* admits a peg or thumb firmly screwed into the lid. If then the slide is pressed downwards by the finger upon the saddle or pommel *k*, then its rectilineal movement by means of slide and peg passes into a circular movement upon the stopcock bolt, which is limited to a quarter



rotation by a suitable escapement. If the finger pressure be now withdrawn, the spring in the cylinder instantly effects the spontaneous return of the stopcock bolt and the slide. It is also possible in this way to change temporarily the communication of the mask tube  $m$  with the flexible tube  $r$  into that with tube  $r'$ , and *vice versâ*.

*The Double Manometer.*—The tensions which the apparatus is capable of producing in the positive and negative sense up to  $\frac{1}{20}$  atmosphere pressure may be effected in three ways: we can either simply rarefy the air in the mantle space, or condense the air in the bell space, or perform both at the same time. It appeared, therefore, desirable to register these tensions, sometimes changing suddenly diametrically according to need, sometimes present at the same time, by means of two manometers, one of which stands in communication with the bell, the other with the mantle space. The latter is effected by two thin indiarubber tubes, which on the one hand are carried over the knee of the manometer tube, on the other over two short tubes which project outwardly from the mantle and bell space at the proper place, and which have been already mentioned.

Instead of the mercury manometer, used with the pneumatic apparatus, the far more sensitive water manometer was selected, which indicates with great accuracy differences of  $\frac{1}{1000}$  atmosphere pressure = 1.030 centimetre difference of the water level in both arms of the manometer. A rise or fall of 0.5 centimetre of the water in the manometer, therefore 1 centimetre difference, does not in the mercury manometer answer even to a difference of 0.735 millimetre, therefore, to the rise or fall of 0.37 millimetre mercury in an arm of a manometer. Such differences and the tensions expressed by them are, therefore, scarcely appreciable by direct observation, whereas the water manometer shows them at many paces' distance with absolute certainty.

Both manometers are united in a wooden box so fastened and arranged that one arm of each is let in at the back of the box, and therefore only the second arm is visible to the observer in front. The visible arm of the bell manometer is that in which the water rises with the incipient condensa-

tion of the air, while that of the mantle manometer is that in which it rises with corresponding rarefaction of the air.

These two arms stand in front of a common scale, which marks centimetre degrees, as also atmosphere pressure in vulgar and decimal fractions. The manometer coupled in this manner is hung above the apparatus on the opposite wall, or attached to it by means of an arrangement for the purpose. In the 'double ventilator' (fig. 43), the combination of two simple apparatus, one of which is used exclusively for the inspiration of compressed air, the other for expiration into rarefied air, the manometer stands in the middle between the two apparatus. Since the columns of water in the manometer rise and fall by

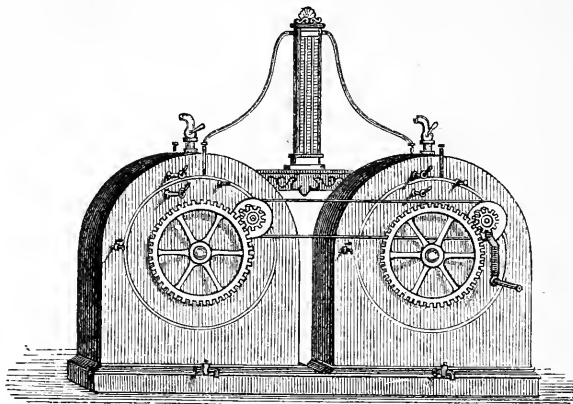

FIG. 43.

51·5 centimetres difference, when the extreme tensions of  $\frac{1}{20}$  excess of pressure or rarefaction are reached in the apparatus, the whole length of the double manometer need not measure more than half a metre.

For more distinct marking of the two manometers the manometer which stands in communication with the bell space in the apparatus is filled with red, that corresponding with the mantle space with blue liquid, and both are so placed that the two liquids rise in the visible arm when the apparatus is set going.

Finally, it is advisable, for considerations of health, to have a selection of face masks in store for the use of the different patients, and patients who can afford it would do well to procure masks for themselves, or else the cheaper and more

cleanly wooden mouthpieces for inhalation of compressed air. In the application of these mouthpieces, the patient easily learns either at once or after frequent holding of the nose, to close the naso-pharyngeal space by raising and contracting the soft palate and to entirely prevent the escape through the nose of the air streaming in under strong pressure. Masks are decidedly better adapted than mouthpieces for expiration into rarefied air. The latter very soon carry the secretions of the mouth into the respiratory valve, while saliva or condensed respiratory water usually accumulates at the bottom of the mask and can be wiped away with a cloth. Again, the nose has to be held during expiration by means of a mouthpiece, which is another drawback.

*The Small Portable Apparatus (fig. 44).*

Besides this large transportable apparatus Geigel and Mayr have also constructed a small portable apparatus in which everything is left out that could possibly be dispensed with, and which yet produces by the mechanism of the water-engine bellows differences of tension sufficiently marked to be used with success for pneumatic purposes. The apparatus, made throughout of sheet iron, weighs when not filled with water no more than 30 kilogrammes, and is 0.6 metre in height and breadth, and 0.28 in depth. Answering to these proportions, the highest pressure attainable by it is 300 millimetres, i.e. somewhat more than  $\frac{1}{40}$  atmosphere pressure, and the amount of air yielded by one rotation of the chambered wheel is about 20 litres.

As in the case of the large apparatus, two of these portable bellows can be combined into a double apparatus, to which, as to the large double ventilator, a double manometer can be affixed. This portable water-engine ventilator would be specially adapted for the private use of individual patients, who have already mastered the physico-technical conditions affecting their own person in the large apparatus.

Whereas the ordinary gasometer apparatus or the handy, but inadequate bellows apparatus, when employed therapeutically, admit at the utmost of subjecting 18 to 36 respirations to a non-variable difference of air pressure, and even this must

be interrupted by frequent pauses for renewed inflation or evacuation ; by means of Geigel and Mayr's apparatus the lung can be ventilated in one sitting through 100 to 150 respirations, and the pressure of air, first slowly increasing and then maintained at constant height, towards the end sinking again steadily, can be made to act 3 to 4, even 5 times as long and with-

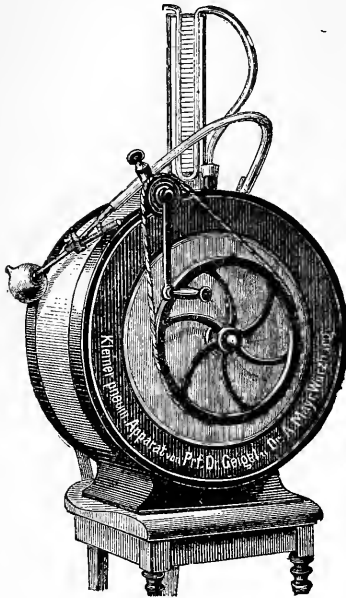

FIG. 44.

out interruption on the abnormally dilated air cells or on the cohering bronchi and collapsed pulmonary vessels. When Geigel and Mayr, however, insist upon sittings up to 100 and 150 respirations, they intend to express not merely a theoretical possibility, but a practical experience which has already taught in the case of far more than 100 patients without exception, that so prolonged a duration of the pneumato-therapeutic sittings was never followed by any disturbances, any ill-effects, or even any indications of such. With the exception of a slight feeling of giddiness, such as frequently occurs in all pneumato-therapeutics, not the

slightest disagreeable incident has been observed in any case, not even in delicate nervous girls, nor in phthisical patients with apical cavities, nor in far-advanced emphysematous cases with asthma and deeply cyanotic lips, although they were submitted to an altered respiratory pressure on their respiratory organs at an average twice and four or more times as long as Waldenburg considered safe.

Then again the patient feels neither tired nor disturbed during the pneumatic treatment carried out by their apparatus, nor does he desire to interrupt the sitting, but rather is frequently surprised by the speedy close of the treatment, to the beneficial effect of which he would gladly have submitted for a longer time, and expresses regret at its cessation.

The possibility of applying the pneumatic treatment so much longer than has hitherto been the case, depends firstly on the variation of air pressure obtainable by Geigel's apparatus which excludes rapid and possibly dangerous changes of the pressure; secondly, on the continuity of action, which enables the patient to subject himself uninterruptedly for a prescribed time to the influence of the altered pressure of air, without being compelled by insufficiency of the apparatus to let pauses intervene, which by no means contribute to make the application pleasant and safe. On the other hand it is a much more serious thing to subject the pulmonary and vascular system to immediate fluctuations between normal and increased or diminished air pressure, than it is to influence those organs quite gradually in gentle transition till the culmination of the physical influence which can be borne is attained, then to let this act to its full extent uninterruptedly for a fixed time, in order ultimately in the same gradual manner to return to the normal conditions of respiratory pressure.

Lastly we must draw attention to the great gain in expenditure of time to be obtained by the new apparatus, as compared with the best of the previous pneumatic apparatus, the gasometer-apparatus. Whereas with Tobold's apparatus 100 respirations under a minus or plus pressure of  $\frac{1}{120}$  atmosphere necessitate 22 minutes' application, Geigel's apparatus produces the same effect in 7.5 minutes. With increase of pressure the ratio is still more in favour of the latter, with  $\frac{1}{40}$  atmosphere pressure with Tobold's apparatus 1 : 4, with Waldenburg's 1 : 5-6, so that thus in the latter case 40 minutes would be required for carrying out 100 respirations. This advantage of saving time is also enhanced by the fact that, in case of need, two patients can inspire at the same time without in the least diminishing the effect. The ratio is thus formulated as 1 : 8.

Many variations in method and amount may be carried out by means of this double respiration, as the frequently-mentioned variability of air-pressure admits of rising to comparatively very high differences of tensions of air. We may, for instance, according to the necessity of the case, begin with +6 and -6 centimetres, in a few respirations pass to +10, -16, rising ultimately in gradual transitions to +16, -30. After the patient

has been submitted to this considerable difference for 40 to 80 respirations, he is led in the same gradual manner in the course of 20 to 40 respirations more, to slighter differences and so back at last to normal atmospheric pressure. The degrees of rarefaction of the air are on an average to be placed considerably higher than those of condensation. Only in some rare cases, with widely diffused bronchitis and violent dyspnœa, an inverted ratio will be advisable at least in the early stages (Geigel).

Geigel and Mayr have, in an original paper: 'The water-engine bellows applied to Pneumato-therapeutics,' published also a series of preliminary experiments on the use of the apparatus, and also described more minutely the pneumotechnics of the single and double ventilator, the employment of the water-engine bellows as a pneumatometre and its pneumato-therapeutic achievements. It is impossible to enter more particularly into this subject, and we must therefore refer to the monograph itself, if further elucidation seems desirable.

Herr Hess at Würzburg, from whose mechanical establishment the apparatus is to be obtained, also supplies instructions of his own with every water-engine ventilator.

---

#### PRACTICAL APPLICATION OF THE PNEUMATIC METHOD.

We find from the minute description of the various pneumatic apparatus which has been given in the preceding pages that the essential difference between them lies in their efficiency, as regards their employment in scientific researches and for therapeutic purposes. Now, while a number of these apparatus are not much inferior to the best from a therapeutic point of view, and are perfectly adapted for medical practice, the simplicity of their construction causes them to fall short of the demands of scientific investigation. But as the price of the several apparatus stand in direct ratio to the perfection of the construction and the amount of efficiency, the first question in procuring and setting up a pneumatic apparatus must be, by whom and for what purpose it is ordered and what other auxiliary means are at command in the employment of it.

The most efficient apparatus now in use is the water-engine bellows of Geigel and Mayr, or rather the double ventilator, which consists of two bellows joined together, and which yields to no other apparatus in accuracy when used for scientific investigations, as well as in constancy, in regular action, and in moderation in its development of force. At the same time the price is somewhat high. In the selection of a pneumatic apparatus, where expense is no object, in clinics, in hospitals, and for specialists, where also assistants and other helps are at hand, to whom the manipulation of the apparatus can be entrusted during the sittings, as the physician himself cannot always be in a position to set the bellows going, decided preference should be given to the double ventilator. In cases, however, in which the high price is a serious objection, and yet an apparatus with accurate and constant action is required in which the pressure-force can be accurately estimated in ordinary degrees, and which is furnished with all auxiliaries for scientific investigations, the apparatus of Waldenburg and Schnitzler is the only one suitable. But it is not only for the physician that these superior apparatus are advisable, they should also be procured by patients who are tolerably well off, and can afford an outlay of 150 to 160 marks, as I have frequently convinced myself that pneumatic treatment, in order to produce any real effect, requires in most cases a more permanent mechanical action than can be carried out ambulatorily in the short sittings of 15 to 20 minutes daily. I have therefore for a long time recommended all patients rich enough, and for whom a continuous application of the mechanical treatment of the lungs is necessary, to procure one of these apparatus for himself, and I have since obtained far better results even in the more unfavourable cases than by ambulatory treatment.

Of the cheaper apparatus the only one worth recommending is Biedert's rotatory apparatus, the price of which is from 42 to 48 marks, as it alone supplies an exact and constant action, and allows the pressure force to be accurately adjusted within the usual limits. The bellows of Biedert's apparatus which is used by itself in the manner described and costs only 20 marks, must be regarded as standing at the limit of the permissible in the apparatus now applicable for mechanical treatment.

The masks and mouthpieces which are supplied with the apparatus for connecting the respiratory tube with the mouth and the nose of the patient, do not differ materially in their suitability. The masks either cover mouth and nose (face-masks), or the mouth only, and are provided with an air-pad that they may fit as nearly airtight as possible to the face, for which purpose they are specially made flexible; the mouthpieces are somewhat pear-shaped and are introduced 1 to 2 centimetres deep into the mouth and firmly secured by the tongue and the lips. Both contrivances exclude the outer air completely. Respiration has to be learned, so to speak, with both these contrivances, and this is somewhat more easily managed with the masks, behind which the patient breathes with open mouth, than with the mouthpieces, in which the breather in inspiring compressed air can easily remove the plus pressure, and diminish the amount of air admitted by contracting his isthmus glossopalatinus. Patients who choose to inspire with the mouthpiece must have their attention called to this, and endeavour to avoid it when they have become accustomed for some time to artificial respiration. The orinal masks possess no advantage over the oral masks, so soon as the patient has learned to respire through the mouth: otherwise the nose has to be closed by a clamp to prevent breathing through it. It is important that the perforated hole in the oral masks, as well as the lumen of the connected tubes should be of approximately the same diameter as the conducting tube, and that the latter should correspond to the width of the natural conducting tube of the lungs, the trachea. In the opposite case the same quantity of air cannot be conveyed in or out within the normal period of an inspiration, the lungs cannot be duly filled or emptied, and in the inspiration of compressed air and expiration into rarefied air, the pressure action will suffer a corresponding diminution. In the apparatus constructed in the best manufactories full account is taken of all these conditions.

The conveyance of fresh air to the apparatus for condensation is best effected from the open air through the window, for which a simple arrangement is necessary; it consists, as was mentioned in describing the water-engine bellows, of a caout-



chouc tube and a tin pipe, introduced in some way or other through the window. In the same way the expiratory air can be conveyed out of the filled cylinder by means of a connecting tube through the window into the open air. We may, however, if not many patients make use of the pneumatic apparatus, and the expiratory air is not, as in putrid bronchitis and in decompositions in bronchiectatic dilatations and cavities, impregnated with unpleasantly smelling and nauseating or actually mischievous substances, have the cylinder emptied in a capacious, well-ventilated room, and we may even take the air necessary for compression directly from the air of the sitting-room in which the patients reside. But it will always be better, if the application of the pneumatic treatment is to be pretty frequent, to make use of the appliances which are to be had at moderate cost in the Ambulatorium of the presiding physicians in health-resorts especially devoted to this treatment.

Closely connected with the supply of pure air to the apparatus is the question of its disinfection, as the possibility of contagion may easily arise when several patients successively make use of the apparatus. Fränkel and Biedert have tried to meet this possibility by the construction of lower-priced apparatus, so that each patient may easily have an apparatus of his own, and Cube has from the first constructed two large apparatus, one for the inspiration of compressed air, the other for expiration into rarefied air, as it is not only unpleasant, but in some cases dangerous, for one patient to inspire out of an apparatus into which another patient has previously expired.

In most cases a due ventilation of the apparatus by repeatedly filling and emptying the cylinder or bellows, as well as the providing separate masks and mouthpieces for each patient, may suffice to meet the actual danger of infection. But in hospitals, cure establishments, and large ambulatoria, it is urgently necessary that there should be either a Geigel's double ventilator or two apparatus of Waldenburg, Schnitzler, Biedert, &c., kept ready for the patient, and that one shall be used exclusively for inspirations, the other for expirations, while of course each patient retains his own mask and mouthpiece.

For disinfecting the apparatus itself, after careful cleansing of the several parts, especially of the cylinder and the

respiratory tubes with a solution of salicylic acid or permanganate of potassium, it will be best to add salicylic acid to the water of the apparatus itself (it is preferable to permanganate of potassium, as the latter readily decomposes on exposure to the fresh air), and to renew the water frequently. Biedert recommends that the bellows of his apparatus should be disinfected with a 50 per cent. alcoholic solution of carbolic acid, either by holding the tube over the vaporised solution in filling the bellows or by filling the apparatus by means of the carbolised '*Medicamentenköcher*.' But the disinfection of an apparatus is not only necessary where several make use of it, but also in cases in which the patients possess their own apparatus, as the accumulation of expiratory and infective decomposing products in the respiratory tube, in the water of the apparatus and in the cylinders reacts injuriously even upon him from whose respiratory organs they are exhaled.

In order to develop the mechanical effect in the most favourable manner, the apparatus above described are so constructed that the patient, when his state allows it, assumes the erect position when inspiring compressed or expiring into rarefied air. But Fränkel's apparatus is most conveniently used in a sitting posture, the patient crossing the left leg over the right and supporting the apparatus, resting on a cushion if necessary, upon the left thigh. When however the patient is not able to carry out the treatment in the erect position it will be best for him to inspire and expire with the upper part of his body leaning against the back of the chair.

For partial action of compressed air on diseased portions of the lungs Cube has suggested the recumbent position on the right side, that the pressure of the instreaming condensed air may be brought to bear especially upon the diseased lung.

In the same sense Knauth recommends that separate movements, such as Schreber has indicated in his chamber gymnastics, should be combined with the inhalations, for partial or general expansion of the chest. For the expansion of the affected half of the thorax, the arm on that side should be raised and the hand laid on the head, while with the other hand the hip or waist of the healthy side is supported; an

assistant must then apply the mask to the mouth of the patient and cause him to respire through the apparatus.

As regards respiration itself, the inspiration of compressed air must succeed a deep expiration, whereas expiration into rarefied air does not require a previous deep inspiration. It is also advisable in simple expiration into rarefied air not to subject the lungs to the aspiratory suction of the apparatus till the expiration is nearly completed. In gasometer apparatus the cylinder is in this manner equal to a greater number of expirations.

Special attention must be devoted to the right application of the valves of the masks and mouthpieces at the outset, till the patient has learned to bring his inspiration and expiration into unison with the movements of the valve.

The handling of the apparatus in Geigel's water-engine bellows must be managed by the physician or an instructed assistant or servant; the other apparatus can be set going by the patient, and only when his strength is insufficient for the application of the weights, an assistant can easily attend to the regulation and to the emptying and filling of the cylinder.

The management of Biedert's bellows always demands the aid of an assistant, which in this case is very easy to procure.

## ACTION OF VARIATIONS OF AIR PRESSURE APPLIED TO THE PULMONARY SURFACE.

### I. MECHANICAL INFLUENCE ON RESPIRATION.

#### 1. *Inspiration of Compressed Air.*

If in a suitably constructed apparatus air is submitted to a definite pressure whereby it is rendered, in a determinate degree, denser than atmospheric air, then, if the apparatus be connected airtight with the respiratory organs, the air will stream into the lungs with a force proportional to the increase of pressure, and this will be attended with a feeling of considerable repletion and dilatation of the lungs and of the thorax, and if the pressure be too high, a sense of oppression and painful dragging which may remain for hours afterwards.

In the lungs themselves the quantity of air which has been

inspired, the cubic volume of which answers to the amount by which the gasometer bell has sunk, mixes with the residual air still remaining in the lungs, in greater or less quantity according to the completeness of the previous expiration, so that its density is now diminished by the lesser density of this residual air in the lungs corresponding to the normal pressure of the atmosphere. If the apparatus at the end of inspiration remains a few seconds longer in communication with the lungs, this difference gradually rights itself, and a sensitive manometer inserted between the apparatus and the mouthpiece enables us to read off directly the degree of density of the air in the lungs and the pressure exercised by it on the pulmonary surface. Thus Cube, who was the first to perform these experiments, observed how the mercury pressure in the manometer which before inspiration harmonised with the air compression of the apparatus, sank suddenly with the beginning of the inspiration, at first considerably, and even as far as 0, i.e. to the ordinary atmospheric pressure, then rose, and at the end of inspiration became equal to that of the compressed air employed.

When after the next expiration the air is again removed from the lungs, there remains behind a residual air, which is denser than the atmospheric air and exercises a pressure on the pulmonary surface, which corresponds approximately to that previously shown by the manometer. If compressed air be now again inspired, it meets a residual air already under increased tension in the lungs, with which it mixes in the same way and thus produces a further increase of the density of the air and of the pressure within the respiratory organs, so that with continued respiration a degree of density of the residual air is soon established which is only slightly, if at all, below the pressure in the apparatus.

This alteration of the physical processes by the inspiration of compressed air must naturally lead to a series of effects upon the mechanism of respiration which are of therapeutic value. As soon as the stopcock of the conducting tube is opened, the air streams out of the apparatus with a force proportional to the pressure to which it is subject, and as this outflow occurs during the inspiratory act, the air will encounter no resistance in penetrating into the lungs. As the propelling pressure

which drives the air into the lungs is greater than the superficial atmospheric pressure, the air as it forces its way in will tend to completely distend the lungs and expand the walls of the thorax, and as the inspiratory muscles are at the same moment engaged in performing the same action, they are aided in their labour by the positive pressure on the pulmonary surface, and so inspiration itself is facilitated.

The immediate effect of inspiration under this definite propelling force of the inspiratory air must be a greater dilatation of the lungs and the thorax than can otherwise occur even with the deepest inspirations. The distension of the lungs and the extension of the thorax must not of course be carried so far as to completely overcome the opposing force of natural elasticity of the lungs or the resistance of the thorax and of the respiratory muscles, but must remain subject to the condition of equilibrium in which the increased intra-pulmonary pressure and the resistance of the lungs and of the counteracting muscles are to be maintained. It is the more important to keep this in mind, because this mechanical treatment is especially applicable to lungs the tissues of which are already diseased and the elasticity of which is reduced by diminution of muscular force. If this limit is over-stepped by too high compression in the apparatus, too great an expansion of the pulmonary tissue follows, the lung is irresistibly distended, loses its elasticity, and emphysema of the lungs with all its sequelæ may be originated, especially after continued application at relatively high pressure, though it should appear absolutely low in cases where the lung tissue is diseased. For this reason we generally use compressions of  $+\frac{1}{60}$  to  $\frac{1}{40}$  and rarely  $\frac{1}{30}$  atmosphere according to the indications and counter-indications present in the individual case.

By the penetration of condensed air into the lungs additional space is created for the complementary air, varying according to the elasticity of the lungs, the expansibility of the thorax, and the applied pressure. In Waldenburg's experiments a strong, healthy man after the deepest inspiration measured as a maximum across the chest at the level of the nipples 98 centimetres; after inspiration of air compressed to  $+\frac{1}{60}$  atmosphere, the measurement was 100 centimetres, and when the air was compressed to  $+\frac{1}{40}$  atmosphere it was 101.5 centi-

metres, so that the expansion of the thorax and the lungs with moderate compression increased by 3·5 centimetres. The expansion of the thorax, previously theoretically determinable, which follows in strict proportion the rise of atmospheric pressure, was also confirmed by Schnitzler, Biedert, and others, as well as by my own repeated experiments.

The quantity of air which, compressed into a small space in the apparatus, is forced into the lungs and there strives to expand itself proportionally to the pressure it encounters, may amount to an excess of several hundred to 1000 cubic centimetres. Calculations were made with the different apparatus already described, and the quantities of the inspiratory air measured, after deep and after ordinary expiration, under normal atmospheric pressure, and after inspiration of compressed air, by Waldenburg, Schnitzler, and others. If we deduct the factor pertaining to the condensation of air, which Waldenburg with a compression of  $\frac{1}{80}$  to  $\frac{1}{40}$  atmosphere and a vital capacity of 3000 to 4000 cubic centimetres fixed as a coefficient of about 50 to 133 cubic centimetres, from the results obtained in his experiments (5800 to 6150 cubic centimetres), then this excess of frequently more than 1000 cubic centimetres could not be inspired but for the increase in the space for the respiratory air obtained in the manner above described.

Though the air in the lungs is at a higher pressure than the outer air, yet, when we do not employ a high pressure, expiration is not laboured, but the passage of the denser air into the rarer atmosphere occurs with satisfactory completeness and without any great effort. But if the air is inspired under too great a pressure, its quantity and tension in the pulmonary air-cells become too great, and expiration is thus rendered difficult. The elasticity of the lung tissue and the weight of the thorax, no longer lifted by the inspiratory muscles, are not sufficient to expel the larger volume of inspired air out of the lungs in the ordinary period of expiration, and the abdominal muscles will therefore be more or less actively called into co-operation. The dogs which Ducrocq caused to inspire compressed air of 30 to 80 millimetres mercury pressure, became at first apnoeic, and it was not till after some time, when the abdominal muscles had been called in to aid expiration, that the process could be

completed. Of course such phenomena do not occur under the ordinary increase of pressure of  $\frac{1}{60}$  to  $\frac{1}{40}$  atmosphere, and the lungs are emptied without difficulty. And even stronger degrees of pressure may be applied and a greater amount of air may be conveyed to the lungs without disadvantage, if the expiration into rarefied air is combined with the inspiration of compressed air, which is most conveniently accomplished with Geigel's double ventilator. A certain slight difficulty of expiration, if it can be easily overcome by the patient, does not, however, in the least interfere with the change of air in the lungs, but increases it by exciting the natural elasticity of the lungs. Speck's careful investigations are conclusive on this point; he himself, after inspiration of compressed air and expiration into rarefied air, immediately recognised an increase in quantity of the air respired.

The residual air which remains behind in the lungs after expiration, is always subject to a higher pressure than the atmospheric air, when compressed air has been breathed, and even in healthy lungs after long-continued inspirations, the subjective feeling of fulness or pressure may remain for some time. Frequently, after air of the ordinary density had been repeatedly inspired and mixed with the denser residual air, it was only gradually that the usual relations between the inner and outer air became established.

The ultimate result of the repeated action of such increased intrapulmonary pressure on the lungs, and the associated increase of respiratory air, due to inspiration of compressed air, continued through weeks and months, is a permanent dilatation of the thorax and lungs. The vital capacity of the lungs is lastingly increased, and this increase may be very considerable.

As by the inspiration of compressed air the thorax has grown accustomed to dilating itself beyond the deepest inspiratory position, this increase of the vital capacity of the lungs will be specially marked in the complementary air, while the space for the respiratory and the reserve air is also increased. The average position of the thorax for tranquil, unforced inspiration becomes widened, and thus the space between tranquil inspiration and forced expiration, i.e. the space for the excess of respiratory reserve-air, increased; an assumption which is con-

firmed by the fact that patients previously dyspœnic breathe more freely or quite lose their dyspnœa from the use of compressed air, even in the intervals between the sittings.

When, as in old age, the thorax by ossification has become rigid and lost its elasticity, or as in the most aggravated forms of emphysema is already so dilated that its further dilatation is no longer possible, the vital capacity of the lungs will experience no further change under the influence of compressed air. The direct proof of the increase of vital capacity of the lungs falls less under the head of physiological than of pathological and therapeutic experiment, and has therefore been hitherto exclusively afforded by patients whose lungs had suffered a diminution of their respiratory surface through some pathological condition. The greatest increase of pulmonary capacity has been obtained in cases of compression of the lung by pleuritic membranes; in bronchitis; less so in bronchitis accompanied with emphysema, unless expiration into rarefied air is freely combined with it; next in phthisical narrowing of the chest and chronic thickening processes in the lung. The increase in such cases amounts in a relatively short time to several hundred cubic centimetres, and even in cases running a less favourable course these results can always be attained. When the result was thoroughly successful, an increase of 1000 cubic centimetres and more was not infrequently observed in the vital capacity of the lung, so that it gradually returned to its former size, or, as in one of Waldenburg's cases, even exceeded it.

In connection with the increased vital capacity of the lungs, the force with which the air is inspired and expired also shows an increase after prolonged use of compressed air, the result of which is a permanent heightening of pneumatometric value. Observers have been able to trace this rise *gradatim* on the pneumatometer up to a point beyond which no further elevation takes place. The increase of respiratory force occurs pretty rapidly under the pressure action of compressed air, and it may rise in a few weeks from 50 to 60 millimetres, to 100-120 millimetres, and even more; in other cases a force which has sunk to 10-20 millimetres may rise to 50-70 millimetres, (Waldenburg). It is of importance, however, that parallel with the increase of the inspiratory force the expiratory force should



not be inferior to it, as such inferiority, especially when it is considerable, indicates a reduced retractive power of the lungs, and demands a modification or suspension of the treatment. In these cases intrapulmonary pressure has already become too great, and there is danger of expiratory insufficiency, which, if inspiration be incautiously prolonged, may give occasion to the formation of an artificial emphysema.

Waldenburg accounts for the increase of expiratory power in the following manner: by the great dilatation of the thorax, the average inspiratory position of it is widened, so that a larger excursion and with it a greater development of force becomes available for forced expiration. The co-efficient of elasticity would have been previously increased, because the lung has been distended further beyond its collapse condition, and thus the expiratory force, in which elasticity forms a positive factor, would be strengthened. But it is simpler to suppose that the increase of the resistance which the expiratory muscles and the elastic lung tissue find after inspiration of compressed air, in consequence of the greater volume and tension of the expiratory air, as we explained above, must eventually lead to a strengthening of the elastic tissue and of the muscles engaged in respiration. From the hitherto developed physical processes following inspiration of compressed air we deduce *à priori* the hypothesis that by the reception not only of a larger quantity, but also of a denser air in the lungs, which again mixes with the residual air remaining in them, a copious removal of the respiratory air and an increased activity of the ventilation of the lungs must take place.

Speck has made direct estimates of the exchange of gases during the inspiration of compressed air, carried out with all desirable precautions. Even at the moderate medium pressure of 6 centimetres of water, the inspiration of compressed air has for its result an increase of the respired air up to 1.32, of inspired oxygen up to 1.13, and of expired carbonic acid about 1.15 above the normal. The increase of the respiratory air rises with increasing pressure, but so that the increase becomes less and less as the pressure is increased.

Neither in the absorption of oxygen nor the excretion of carbonic acid is there shown an increase proportional to the

pressure as in the case of the respired air. The increase of the inspired and of the expired air occurs in pretty nearly equal measure; the relation between them is therefore almost normal; the expiratory air is only very slightly increased in comparison with the respiratory air. The proportionate amount of oxygen exhaled in the form of carbonic acid is slightly raised (1 : 1.05), therefore less oxygen is retained in the body than in normal breathing, at the same time the respirations increase in depth in the ratio of 1 : 1.30, while the frequency is only inconsiderably increased. The respirations again immediately diminish in depth, and resemble the deepest in normal respiration; they also correspond in frequency to the highest of normal breathing and so remain for some time.

The increase in the exchange of gases is of therapeutic importance, especially in cases in which either the respiratory surface is diminished and shrunken, or where a natural compensation by increased frequency of respirations is no longer possible. By the mechanical clearing away of the hindrances in the bronchi and the re-opening of closed air passages, by which the parts of the lung lying behind the obstruction become again capable of breathing, by the dilatation of thickened lung-tissue and by compression of the swollen mucous membrane narrowing the bronchial channels, as well as by increased ventilation of the lungs and accelerated exchange of gases, the normal supply of oxygen is restored, and the dyspnoic condition alleviated.

Lastly, inhalations of compressed air have been said to promote expectoration—an influence which may be thus explained; the compressed air forcing its way through the inspissated mucus adhering to the bronchial mucous membrane, and narrowing and partly closing the lumen of the bronchi, fills the lung spaces lying behind them, and thus provides at the next expiration a force acting from the periphery towards the centre, which drives the mucus upwards and causes it to be expectorated.

## 2. *Expiration into Compressed Air.*

The immediate effect of expiration into compressed air is due to the introduction of an impediment *into* the expiratory

current. The expiratory air must overcome this more or less completely, in order to escape, while some portion of it is always retained in the air-passages and the lungs. In performing this task, the expiratory muscles encounter a greater strain than in ordinary expiration, as the pulmonary air must be submitted to a pressure which will overcome the tension of the air in the apparatus.

The air expired in this way is not only of greater density, but its volume is greater on account of the increased power of expansion,<sup>1</sup> always supposing the counter-pressure in the apparatus is completely overcome; if this is not the case, the expiratory air, although of equally high density, loses in volume, and under normal respiratory pressure, is less than would correspond to the existing capacity of the lung.

The maximum of the effect lies below the limit up to which the expiratory pressure is capable of raising the mercury of the pneumatometer and maintaining it some seconds at the same height. If the pressure in the apparatus balances the maximum of the expiratory pressure, then no excess of air will pass out of the lungs into the apparatus and the expiratory effect is = 0. If now the pressure in the apparatus is still further increased, then, when the apparatus is connected with the lungs, the pressure of the air in the apparatus will overcome the expiratory pressure and stream into the respiratory organs. Thus expiration is converted into inspiration, and if the communication between the apparatus and the lungs is not interrupted, the result is apnoea in the position of forced inspiration. The diminution in the quantity of expired air below that corresponding to the vital capacity, when expiration is made into strongly compressed air, is, according to Waldenburg, at first at the expense of the reserve air. If the compression be increased, the thorax and lungs can no longer perform the ordinary expiratory contraction, and a portion of the *respiratory* air then remains behind in the lungs. Finally, on further increase of compression, the thorax is no longer capable of retracting up to the ordinary *inspiratory* position, but remains dilated in the position of ordinary forced inspiration, and there remains in

<sup>1</sup> This does not seem quite clear.—TR.

the lung not only the residual air, but also the reserve air, the respiratory air, and even a portion of complemental air.

The exchange of gases in the lungs is also affected by this action on the expiration, but it is not, from the first, in proportion to the impediment introduced. Speck, who by direct estimation of the respiratory air showed how every change of pressure of the air, whether it regards inspiratory or expiratory air, causes stimulation of the respiratory process in all respects, was the first to discover the remarkable fact, that even conditions of pressure which retard respiration, are yet *followed* by increased activity and energy of respiration. It is only when higher degrees of pressure are employed, when the lung can only expel a small portion of its expiratory air, that the exchange of gases becomes also proportionally diminished, and is reduced to the lowest limit or altogether suspended.

In opposition to earlier hypotheses, Speck's investigations show that during expiration into compressed air even with slight pressure (averaging 10·6 cubic centimetres of water), the respiratory air is increased in the ratio of 1 : 1·32, and the absorbed oxygen and excreted carbonic acid are also increased in the ratio of 1 : 1·14 and 1 : 1·21. Although an increase of respiratory air in definite proportion to the pressure does not occur, an increase in the absorption of oxygen is unmistakable, the amount probably being about 0·006 gramme for each cubic centimetre of water pressure. It is also probable that the excretion of carbonic acid is increased in proportion to the pressure, for the largest increase of carbonic acid coincides with the highest pressure. The numerical ratio of inspired air to expired is certainly, especially in experiments in which the respiratory air is greatly increased, highest when the pressure is highest. The proportion of oxygen remaining in the body is on an average considerably diminished (to 0·54 of the normal quantity), and most so at the highest pressure, but it was not observed to follow a definite ratio constantly proportional to the pressure. The depth of the respirations is increased (on an average 1·29); their number remains normal.

Even some time after expiration into compressed air, Speck found an increase in the respired air to 1·23, in the oxygen absorbed to 1·11, but in the carbonic acid exhaled only to 1·03;

this increase was greatest after the strongest pressure. The proportion of inspired to expired air soon returned to the normal, as also the proportion of the oxygen absorbed to that exhaled in the carbonic acid. Lastly, as regards the depth and frequency of the respirations, the former returned to the normal immediately, but the number of respirations remained evidently increased, and that in proportion to the pressure previously exercised.

The therapeutic advantage to be derived from this method is restricted to very narrow limits, if indeed any use can be made of it ; so far we have no experience on the subject. The only advantage to be derived from it would be a strengthening of the expiratory muscles, as shown by the pneumatometer, but it is doubtful if this would exercise any influence upon the elasticity of the lungs or increase their vital capacity.

### 3. *Inspiration of Rarefied Air.*

When one inspires out of an apparatus in which air is kept by a constantly acting negative pressure at a definite degree of rarefaction, not only will a smaller quantity of air than that which answers to the vital capacity of the lungs be with great effort inspired at each respiration, but the suction action of the apparatus which keeps the air at the determined degree of rarefaction antagonises the inspiratory effort and has at the same time to be overcome. As suction of air into a space is only possible when it is either void of air or the air in it possesses a lower density than the outer air, therefore in the inspiration of rarefied air the thorax must dilate so far that the air in the lungs becomes of lower density than that in the apparatus. From this it also follows that in order to be still respirable the degree of rarefaction must be kept within narrow limits. If the negative pressure of the air in the apparatus is equal to the maximum value of the forced inspiration, no more air will be inspired, the density of the air in the apparatus and in the lungs is equal, the aspiratory suction of the apparatus and the inspiratory force of the thorax are equally balanced. If this limit is now exceeded by increase of the rarefaction of the air, then the suction power of the apparatus overcomes the

inspiratory suction, the dense air streams out of the lungs into the rarer air of the apparatus, the thorax passes from the position of active inspiration into that of passive inspiration, and apnoea ensues.

The effect which the inspiration of rarefied air produces upon the thorax, is open to direct observation, since, so soon as the rarefaction of air is sufficiently great, just as in croup or in other aggravated stenosis of the larynx and the trachea, the anterior and inferior part of the thorax and the supraclavicular and jugular fossæ are more or less drawn in. Moreover, the objective phenomena are attended by corresponding subjective sensations. The patient inspires with effort which increases with the amount of rarefaction, and he feels that the quantity of air he conveys to his lungs does not correspond to the muscular exertion.

The ventilation of the lungs and the exchange of gases will also be necessarily interfered with by these altered inspiratory conditions, according to the amount of the rarefaction of the air employed, and the consequent diminution in the quantity inspired. As in the case of expiration into compressed air, the inspiration of rarefied air also acts by the increased excitement which the hindrance introduced produces in the respiratory apparatus, so that at first, with slight rarefaction of the air, the respirations are increased in frequency, and the exchange of gases is accelerated, till, as the rarefaction increases, a rapid decrease sets in, and the respiratory effect ultimately sinks down to nil.

Speck found in his investigations that the inspiration of rarefied air at the negative pressure of 16 centimetres which was high in comparison with the proportions previously employed, produced on an average an increase of the quantity of air inspired of 1.39, an increase of oxygen absorbed of 1.11, and of carbonic acid liberated of 1.23. The increase in this case occurred in proportion to the increase in the rarefaction of the air: i.e. the quantity of air inspired, increased by about 200 cubic centimetres for 1 cubic centimetre of negative pressure, the oxygen by about 0.005 to 0.006, and the carbonic acid by 0.010. The free oxygen expired (not combined as carbonic acid) was very much diminished, and was in proportion to the normal as

0.28 : 1. The proportion of inspired to expired air was increased, rising with the negative pressure. The depth of the respirations increased with the rarefaction of the air in the ratio of 1 : 1.29, while their frequency suffered no change.

Even some time after the inspiration of rarefied air, Speck was still able to detect an increase in the air respired (1 : 1.12), which appeared to be augmented in proportion to the rarefied condition of the air that had been previously inspired; on the other hand, absorption of oxygen and excretion of carbonic acid returned to their normal amount. On the whole the quantity of oxygen exhaled by means of the carbonic acid during these inspirations was less than under normal conditions. After the close of the experiment, the depth of the inspirations returned to the normal, but their frequency still remained greater.

Therapeutically, the inspiration of rarefied air affords a methodical gymnastic exercise, and strengthens the inspiratory muscles. As the inspiratory muscles encounter increased resistances, during a prolonged application of the treatment they become exercised to overcome these resistances more and more. According to Waldenburg's observation, persons who with  $\frac{1}{4.0}$  atmosphere rarefaction only depressed the cylinder 1 to  $2\frac{1}{2}$  centimetres were able after 1 to 4 weeks' exercise with the same amount of rarefaction to reduce it with ease three or four times as much and to expire a quantity of air not much inferior to their vital capacity. The same persons gradually overcame a rarefaction of the air of  $\frac{1}{1.20}$  to  $\frac{1}{8.0}$  atmosphere and even more, and withdrew in spite of this great rarefaction of the air 1000 to 2000 cubic centimetres and upwards, from the apparatus with every inspiration.

As Waldenburg employed inspirations of compressed air together with inspirations of rarefied air, it was impossible for him to obtain clear observations on the pneumatometers, as to the increase of inspiratory force by methodical applications of this method. Inspirations of rarefied air have not yet been employed therapeutically elsewhere.

For the reasons already given, clear observations are also wanting as to any increase in the vital capacity of the lungs arising from inspiration of rarefied air; but any increase in this case would be less than in inspiration of compressed air, as

the factor of mechanical dilatation of the chest which is at work in the latter case is absent. According to Waldenburg, the vital capacity of the lungs will be increased by the inspiration of rarefied air in the same measure as is observed in other suitable gymnastics, or from residence in elevated regions. (v. infra.)

#### 4. *Expiration into Rarefied Air.*

In expiration into rarefied air the expired air is discharged into an enclosed space containing rarefied air of determined negative pressure; the density of the air in the apparatus is maintained uniform by immediate rarefaction of the air as it enters either by elevation of the cylinder in the gasometer apparatus, by distension of the bellows in the bellows apparatus, or by the rotations of the wheel in the water-engine bellows. A suction action is also at the same time exerted, not only causing an easier flow of the denser air into a rarer medium, but also its active aspiration. Besides voluntary expiration there is also a simultaneous pumping out of the pulmonary air and thus a great temporary emptying of the lungs is secured.

If the apparatus be suitably constructed, we can not only maintain the air we employ continuously at a constant degree of rarefaction, but we can also accurately determine the force exerted on the lungs by a constant suction action. If now we introduce a sensitive manometer into the respiratory tube between the mouthpiece and the apparatus, it will also immediately show the decreasing density of the air during expiration and aspiration, till finally, if the apparatus remains in communication with the respiratory organs for a few seconds after the deepest expiration, the density of the air in the lungs and in the apparatus becomes equalised, and the manometer then shows the rarefaction of the residual air in the lungs as well as the diminution of intrapulmonary pressure.

The rarefaction of the air is therefore here determined according to the formula,

$$x : d = b : a + b \text{ or } x = \frac{d \cdot b}{a + b},$$

if  $d$  represents the density of the atmospheric air or of the pulmonary air before expiration,  $b$  the cubic capacity of the



respiratory organs, and  $\alpha$  the capacity of the respiratory tube and of the cylinder, which is filled with air by the expiration and the aspiratory suction. The rarefaction of the air in the lungs bears the same proportion to the density of the former pulmonary air as the cubic capacity of the respiratory organs to the sum of the cubic capacity of the respiratory organs and of that expired into the cylinder.

As the air in the respiratory organs becomes rarefied, and the intra-thoracic pressure sinks below the normal atmospheric pressure, the latter must also press with greater force upon the movable walls of the chest, compress them and cause a diminution of space corresponding to the difference in the amount of pressure and to the mobility and contractility of the thoracic walls. The positive atmospheric pressure and the negative pressure applied to the surface of the lungs will therefore in expiration into rarefied air have a similar influence on expiration.

The aspiration of the apparatus and the influence of the consequent rarefaction of air in the lungs is also felt subjectively. The patient feels during expiration into rarefied air as if the thorax were constricted and the diaphragm with the abdomen drawn forcibly upwards towards the chest. This sensation of compression is felt most in the inferior lateral and anterior parts of the thorax, and may be aggravated so as to become intolerable or even accompanied by more or less acute pain in the walls of the chest if the rarefaction of the air be increased. In the case of healthy persons there is usually no sensation of excess till the rarefaction of the air is greater than  $\frac{1}{30}$  atmosphere, whereas sick persons suffer from a far slighter rarefaction of air. From these simple mechanical conditions which come into play in expiration into rarefied air, may be deduced a series of effects acting directly on the respiratory organs and the respiratory process itself.

In the first place, it follows as an immediate result that expiration into rarefied air is freer than that into ordinary air, and indeed the quantity of expired air is constantly greater than that of the vital capacity as determined by the spirometer. The quantity of expired air also corresponds within certain limits to the amount of rarefaction applied and the aspiration

thus produced; on the other hand, the quantity of air which is discharged in this manner will be dependent on the amount of air contained in the lungs, as well as on the elasticity and compressibility of the respiratory organs.

The amount of air which is expired over and above the vital capacity in expiration into rarefied air is a part of that air which is left behind in the lungs after complete normal expiration and which is termed residual air. The volume which can still be withdrawn from the air even in a normal lung amounts, according to the concordant investigations published, to several hundred and even over 1000 cubic centimetres. Thus in lungs whose vital capacity amounts to 3000 to 4000 cubic centimetres, we can, by expiration into air rarefied up to  $\frac{1}{60}$  to  $\frac{1}{50}$  atmosphere of negative pressure, obtain 500 to 1000 cubic centimetres, while with stronger rarefaction of the air the quantity exceeds 1000 and even 2000 cubic centimetres. According to these investigations we are also compelled to estimate the amount of residual air under physiological conditions as higher than has hitherto been believed, for the volume of residual air withdrawn from the lungs by the pneumatic apparatus can only be regarded as a fraction of the quantity actually present.

The greatest amounts of expiratory air are always obtained in the case of emphysematous patients, if the disease is not very far advanced and if the thorax has not, especially through senile changes in its walls, lost its mobility. In these cases it usually happens that by expiration into slightly rarefied air and with slight aspiratory suction, 1000 to 2000 cubic centimetres, and even more over and above the measure of their vital capacity, therefore of the residual air, can be extracted from the lungs. Waldenburg even brings forward examples in which emphysematous patients expired 5000 to 6000 cubic centimetres of air into the cylinder with a rarefaction of air of  $\frac{1}{60}$  to  $\frac{1}{40}$  atmosphere of negative pressure, whereas their lung capacity amounted only to 2000 to 3000 cubic centimetres. He mentions as the extreme result of his observations a patient who, with a vital capacity of 4350 cubic centimetres under the action of  $\frac{1}{27}$  atmosphere of negative pressure expired into the apparatus 7800 cubic centimetres, therefore 3450 cubic centimetres of his residual air.

It cannot be disputed that by the withdrawal of such large volumes of air a very important influence must be exercised on the mechanism of respiration and on the physical properties of the respiratory organs and especially the elasticity of the lung-tissue, such as was formerly impossible by other therapeutic methods, long-continued gymnastics, electric treatment of the thoracic muscles, residence in elevated health-resorts and even in the pneumatic chamber, and that probably approximate results could only be obtained by the mechanical treatment of the thoracic organs introduced by Gerhardt.

As by expiration into rarefied air the density of the air left behind in the lungs has suffered a reduction, which is proportional to the amount of the negative pressure applied and of the volume of air expired in consequence into the apparatus, therefore as already mentioned, according to the formula

$x = \frac{d \cdot b}{a + b}$ , the external air when it is now inspired under the

ordinary atmospheric pressure, will penetrate with augmented force into the lungs and fill the air cells which contained considerable quantities of residual air, with fresh respiratory air. As the residual air, like the respiratory air, contains a proportion of carbonic acid, to be estimated at 4 per cent., while the freshly conveyed air should hardly contain more than 0.1 per cent., therefore by the continued expiration into rarefied air and inspiration of normal air the exchange of gases in the lungs is accelerated in quite an extraordinary degree and the lungs are better ventilated than by any other means. But also by the efflux of residual air and the influx of air highly charged with oxygen an increased decarbonisation of the blood is brought about, and an antidyspnoëic influence exercised which comes into prominence chiefly where the expiratory power is diminished in lungs which are for the most part emphysematous, and contain a considerable amount of stagnant air.

Speck has also directly tested the influence of expiration into rarefied air upon the exchange of gases in the lungs, from which it appears that even with slight rarefaction (on an average 7.8 centimetres of water), the respiratory air is considerably increased, as much as 1 : 1.62; there is an increase in the absorption of oxygen 1 : 1.14, and in the excretion of carbonic

acid 1 : 1.30. This rise occurred gradually with the increasing rarefaction of the air, but, in the case of respired air and carbonic acid, not uniformly, a considerable reduction occurred as the rarefaction went on increasing. Speck failed to detect distinctly any such result with regard to the oxygen. The increase in the respiratory air in all the experiments lasted only to a slight extent, for any length of time after the action of the rarefied air on the respiration. The depth of the respirations remained unaltered, while the frequency seemed to be increased.

If we now inquire into the results which the expiration of such large volumes of air produces on the respiratory organs, these will be found in the altered physico-mechanical conditions; in the first place, by the increased pressure of the external atmosphere upon the surface of the body in consequence of the diminished pressure on the inner surface of the lungs, the thorax generally is strongly compressed and its capacity is reduced by the upward pressure of the diaphragm; and in the second place, owing to the lowered expansive force of the air contained in the air-cells the elastic tissue will be strongly retracted and the volume of the lung will be reduced so far as the retractility of the wall of the chest permits. Beyond this limit no further reduction of the size of the lungs is possible, and when that is reached, the cylinder in the gasometer apparatus, after complete expiration, remains fixed in its place and does not rise higher.

Waldenburg measured the diminution in the circumference of the thorax during expiration into rarefied air, and found with a rarefaction of  $\frac{1}{40}$  atmosphere negative pressure the circumference of the chest was reduced 2 centimetres, and with a rarefaction of  $\frac{1}{24}$  atmosphere negative pressure about 3 centimetres compared with its usual expiratory position. The rise of the diaphragm can also be ascertained by percussion.

Finally, the expiratory muscles are aided by the retraction of the thorax, as the resistance which is opposed to its reduction in size, is weakened by energetic and copious withdrawal of the air contained in the lungs, and the expiratory force is increased. Expiratory insufficiency, such as characterises the respiration of emphysematous lungs, is therefore the chief indication for the application of the method under consideration. But, lastly,

an increase of inspiratory force can also be detected, and is founded on the fact that the thorax in consequence of the diminution of its circumference by expiration is able to make a wider excursion than before in the succeeding powerful inspiration. The inspiratory muscles can manifest a greater power, as the resistances to inspiration are reduced.

The increase of both inspiratory and expiratory force can be directly estimated by the pneumatometer after prolonged application of this treatment.

All these results gradually following from the continuous methodical application of expiration into rarefied air, are summed up finally in a more or less considerable increase of the vital capacity. The observations here referred to are of course not to be made on healthy lungs, but on those already pathologically altered, especially on emphysematous lungs.

The vital capacity, as is well known, is composed of the space taken up by the reserve air, the respiratory air, and the complemental air. Since by expiration into rarefied air the medium respiratory position of the diaphragm gradually moves farther up, the space between the ordinary and deep inspiratory position becomes considerably enlarged and consequently the complemental air also materially increased. Waldenburg further assumed that as the retraction of the lungs is more prolonged than under ordinary conditions, it is highly probable that the space between the ordinary and forced expiratory position is enlarged, and thus also the quantity of reserve air increased. If, lastly, dyspnœa exist even during quiet breathing, so that the ordinary respiratory air is not sufficient for the decarbonisation of the blood, if such a patient be allowed to expire into rarefied air for a long time, his lungs, in proportion as they become smaller, will afford space enough for the normal respiratory expansion, or the previously abnormally small quantity of respiratory air will increase and return to the normal amount.

With regard to the extent to which the vital capacity may be increased, it is always most considerable in those persons in whom it has been reduced by dilatation of the lungs, i.e. in emphysematous subjects; the more the capacity approaches the normal, the slighter is the increase which can be obtained through treatment by means of the pneumatic apparatus.

Estimations of the increase of the vital capacity of emphysematous lungs by means of the spirometer generally give increases of 500 to 1000 cubic centimetres within a few weeks, while increases of over 1000 and 1200 cubic centimetres, even after a comparatively short duration of the treatment, have been repeatedly observed. Lastly, the changes which emphysematous lungs undergo from the effect of this treatment are unmistakably detectible by percussion.

If we now sum up the separate effects of expiration into rarefied air, there is, on the one hand, the removal of larger quantities of air from the lungs than in ordinary expiration, as well as an acceleration of the exchange of gases by the pumping out of a considerable portion of the residual air charged with carbonic acid, and the admission of larger volumes of atmospheric air charged with oxygen; then, on the other hand, there is the diminution of the circumference of the thorax, the retraction of the lungs, the increase of the inspiratory and expiratory force, and finally, the augmentation of the vital capacity of the lungs, and theoretically we may deduce from these effects that this method is capable of directly removing dyspnoea which is the result of expiratory insufficiency and is also the surest means of averting its return. The experiences of practitioners are in perfect harmony with this theory. Emphysematous patients who come to the apparatus with the symptoms of violent dyspnoea, so long as this does not altogether hinder the application of the mask and the carrying out of artificial respiration, will at once feel a progressive relief and leave the apparatus without a trace of dyspnoea. The anti-dyspnoeic effect will also remain permanent later on under the methodical use of expiration into rarefied air, as a more vigorous ventilation of the lungs is henceforth brought about by the increase of their vital capacity and of the expiratory force, and thus the worst forms of dyspnoea are warded off from the first.

Other observations upon the effect of this and of the other modifications of altered air-pressure on the respiration will be specially dwelt upon when we come to treat of the indications which are presented by the several diseases for the application of pneumatic treatment by means of the transportable apparatus.

## II. MECHANICAL ACTION ON THE HEART AND THE CIRCULATION.

1. *Inspiration of Compressed Air.*

The influence of the inspiration of compressed air on the heart and on the circulation is also mechanical, and is the result of the increase of the intra-thoracic air pressure and the pressure thereby induced on the heart and on the walls of the pulmonary vessels. In order to understand this, we have only to bear in mind the physical and physiological conditions which here come into play.

In consequence of the great dependence of the state of the blood current on the external atmospheric pressure, it follows necessarily that changes in these pressure relations will influence very considerably the volume of blood circulating in the lungs, as well as that in the heart and the aortic system. So long as the air is drawn from the atmosphere by the inspiratory dilatation of the thorax, the density of the air in the lungs is diminished by their rapid expansion and becomes less than that of the external air. The heart experiences a diminished pressure on account of the rarefaction of the air in the adjacent lungs and therefore dilates more easily. So that during inspiration, the venous blood flows back more easily into the heart, while the arterial blood, on the other hand, is expelled with less force, and the blood pressure in the aortic system is diminished. By the time the density of the two columns of air is nearly equalised, inspiration is complete, and the air is again driven out of the lungs by the mechanism of expiration. The pressure exercised upon the lungs in expiration is also conveyed through compression of the air contained in the air-cells to the pulmonary vessels and the heart, which contracts more easily under its influence. It follows, as the immediate result of this, that the amount of blood in the lesser circulation is diminished, and the flow of blood back to the heart is retarded, the superficial veins become distended, and, if they are pricked, the blood flows more freely from them; on the other hand the blood flows more freely towards the periphery, the arteries are filled with increased force, and the blood pressure in the aortic system is raised during expiration.

The conditions of circulation directly or indirectly dependent on the altered physical conditions due to inspiration of condensed air will be altered in proportion to the extent of condensation, and the mechanical force thereby brought into play. In the first place the suction action of the lungs in inspiration is diminished by the influx of air under a higher pressure from the apparatus, causing a rapid diminution of the negative pressure in the lungs induced by the inspiratory dilatation of the thorax, till at the end of inspiration, the degree of density of the air in the lungs and in the apparatus is almost entirely equalised. The next result of the diminished rarefaction of the air and suction action during the inspiratory dilatation of the thorax is, that the walls of the heart are also less exposed to this suction influence, and are strengthened in their systolic contraction, while their dilatation, during diastole, must be impeded. Moreover, in consequence of the rapid increase of air pressure in the air cells of the lungs, the suction action of the inspiratory movement upon the current of blood in the lungs is considerably diminished, and a greater or less resistance presented to the flow of blood into the vessels now submitted to a slighter negative aspiratory suction or even to positive pressure. The blood which at first still flows in normal quantity into the ventricles, is driven with strong propelling force into the systemic arteries, while the efflux from the veins into the right auricle diminishes as the air streams into the lungs under high pressure. It always happens that less blood passes into the right ventricle, and these phenomena reach their climax when the pulmonary air experiences the same pressure as that in the apparatus. In consequence of the impediment to the efflux of blood from the intra-thoracic vessels by compression of their walls and narrowing of their channel, the systemic veins become engorged with blood, and the thoracic organs, and especially the lesser circulation, become emptied of blood. These alterations in the flow of blood lead to a variable degree of hyperæmia in different parts of the systemic circulation: the arteries will gradually receive less blood from the heart as the pressure increases, while its outflow is likewise impeded by the venous engorgement. We must make these conditions specially clear with reference to estimating the



action of compressed air on the circulation and the accumulation of blood in the aortic system.

When expiration follows, the pressure which even in normal breathing is somewhat positive, will now be increased in proportion to the density and volume of air in the lungs after inspiration of compressed air, and the influence it ordinarily produces will consequently be increased. The diastolic dilatation of the ventricles is much impeded, the systolic contraction promoted. The outflow of the blood from the right auricle is more retarded than in normal expiration, the lesser circulation receives considerably less blood, while its main bulk is retained in the systemic circulation and especially in the veins. It is only at the close of respiration, when the intrapulmonary pressure decreases owing to the removal of the greater mass of air, that a more copious flow of blood again takes place towards the right heart and the lungs, not however to the same amount as in normal inspiration, but it increases more markedly when the inspiratory dilatation of the thorax occurs with greater rapidity than the influx of compressed air through the narrow air passages, and thus with the enlargement of the intra-thoracic space a temporary rarefaction of the air and suction action occurs. As soon as the compressed air has again streamed in, in sufficient quantity, immediately the former circulatory changes reappear.

These theoretic conclusions can be compared with the direct kymographic experiments of Drosdoff, Botschetschkaroff and Ducrocq on the conditions of the blood pressure and the circulation during inspiration of compressed air. As Ducrocq used only very high degrees of pressure, from 30 to 80 millimetres mercury, in his experiments, we cannot accept them as decisive in the question we are now considering, viz. the mode of action of lower degrees of pressure. Among the results of his investigations, he once obtained a diminution of the blood-stream and a fall of blood pressure in the aortic system, with an increased outflow from the veins into the right heart and an accumulation of blood in it and in the thoracic veins, while the right heart itself was no longer able to overcome the pressure which acted upon the pulmonary capillaries, and the circulation of the blood in the lesser circulation was arrested. With regard to the pulse Ducrocq found that it was subject to great modifi-

cations, according to the height of the pressure applied ; it was most frequent when the pressure of the inspired air was only moderately high ; on the other hand it experienced a considerable retardation when the pressure amounted to more than 50 millimetres mercury.

Animals employed for experiment succumbed under the influence of degrees of pressure higher than those ever employed therapeutically, and this is a result not to be lost sight of, as no doubt in the case of the human subject also the action of the heart and the circulation may be arrested and death induced by a like proportional rise of intra-thoracic pressure.

The experiments of Drosdoff and Botschetschkaroff were more completely restricted to such degrees of pressure as are employed in pneumatic treatment, and their results are therefore better calculated to demonstrate the changes in the circulation of the blood which are called forth at the time by the action of compressed air. The greater part of their experiments were carried out under the influence of excess of pressure amounting to  $\frac{1}{6}$  of an atmosphere, but the same results were obtained with compressed air at other variations of pressure, with the highest as with the lowest degrees. The respiratory waves became larger and deeper than normal, and the whole act of respiration became slower.

The blood pressure fell as soon as the animal began to inspire compressed air, and remained diminished so long as the inspiration of the compressed air lasted. After the trachea was separated from the apparatus, the blood pressure rose for a short time above the normal, and then became normal again.

The figures in the following table are drawn up according to the kymographic curves :

Normal Breathing		Breathing Compressed Air		Degree of Compression. Height of Manometer
Min.	Max.	Min.	Max.	
132	140	134	140	$\frac{1}{242}$
140	160	120	144	$\frac{1}{120}$
130	140	88	132	$\frac{1}{60}$
136	140	94	108	$\frac{1}{50}$
120	124	90	118	$\frac{1}{40}$
124	140	80	110	$\frac{1}{36}$
126	150	70	96	$\frac{1}{30}$
136	150	80	98	$\frac{1}{27}$
140	150	64	90	$\frac{1}{25}$
136	140	60	80	$\frac{1}{23}$
138	146	60	84	$\frac{1}{20}$

The heart's beat was increased in frequency during inspiration of compressed air, and was diminished, for a little time, after its cessation.

The force of the heart's action was diminished during the inspiration of compressed air.

The negative pressure of the thorax in the act of expiration of compressed air remained diminished in comparison with the normal; at the same time venous engorgement and the blood pressure within the veins increased.

Level of the mercury in the manometer connected with the jugular vein in normal breathing:—

Inspiration	Expiration
10.1 millimetres	10.2 millimetres
9.9     "	10.1     "

Level of the mercury in the manometer connected with the same vein during inspiration of compressed air:—

Inspiration	Expiration
10.6 millimetres	10.8 millimetres
10.8     "	10.85     "

During the inspiration of compressed air the lung-tissue became paler and the lungs quite white, as was observed by inspection when a small piece of the rib was carefully resected.

Irritation of one of the sensory nerves (n. ischiadicus) and division of one of the vagi did not interfere with the effect of inspiration of compressed air on the blood pressure.

Lastly, in order to prove that the effect of compressed air was wholly mechanical, Drosdoff and Botschetschkaroff employed

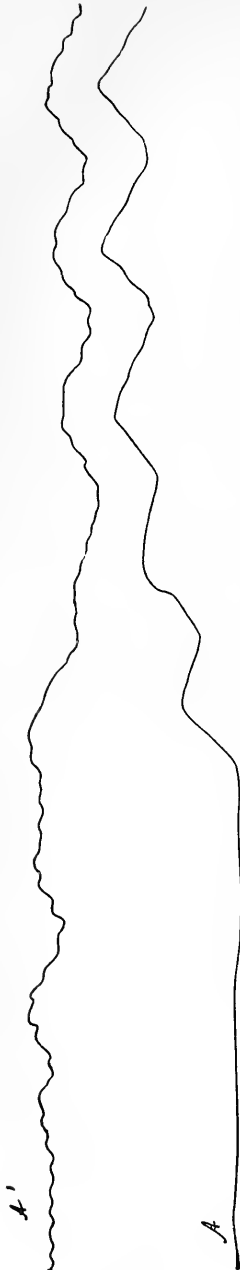

FIG. 45.

pure hydrogen for inhalation in their experiments under the same conditions, and obtained the same results.

Zuntz's<sup>1</sup> observations confirm those of Drosdoff and Botschetschkaroff, although he failed generally to obtain such marked depressions of pressure as are shown by the figures of the latter. Zuntz attributes this to the fact that he employed very large, powerful dogs for his experiments. In fig. 45 the curves A and A' represent the tracheal pressure and blood pressure during expiration of compressed air of + 18 mm. Hg =  $\frac{1}{2}$  atmosphere excess of pressure. As no valve was used, but the turning of the cock was adapted as exactly as possible to the spontaneous respiratory acts of the animals, the conditions of the experiment entirely corresponded to the therapeutic method employed with the human subject.

The first part of the curve A is drawn during normal respiration, and, owing to a certain stiffness of the lever, in order not to make its excursions excessive in the subsequent considerable fluctuations of pressure, the feeble respiratory fluctuations in the trachea are hardly expressed in the respiratory curve. During the first inspiration of compressed air the respiratory curve rises considerably, corresponding to the increased pressure in the trachea; in the succeeding expiration into the ordinary atmosphere the pressure sinks again, but not nearly to the previously maintained level. And so in the second inspiration a higher summit

<sup>1</sup> N. Zuntz, 'Contributions to the Investigation of the Influence of Respiration on the Circulation,' Pfüger's *Archiv*, vol. xvii. 1878.

is reached, in the third a still higher, and it is only now that the summits which correspond to the highest tracheal pressure occurring during inspiration remain at the same level. The curve shows, in agreement with our theoretic deductions given above, that the increased pressure exercised upon the internal pulmonary surface during inspiration also acts strongly upon the expiratory phase, although expiration occurred freely into the atmosphere. During the respiration of compressed air the expiratory depressions of the curve also stand considerably above the line indicating the tracheal pressure in normal respirations.

The curve of blood pressure behaves differently. At the moment of the first inspiration of compressed air the curve A' shows a slight rise of 120 to 123 mm. Hg, in the subsequent expiration a fall amounting to 108 mm.; during the next inspiration it runs almost horizontally and hardly reaches 110 mm., sinking in the next expiration as low as 103 mm. The extreme points are: inspiration 113 mm., expiration 106 mm., inspiration 116 mm., &c.

The result of these figures, and still more of the inspection of the curves from which these were taken, shows that both for air pressure in the lungs and for blood pressure it is not until the third respiration that the conditions corresponding to compressed air become more stable; indeed, we might be led to the assumption that not even then had the state of equilibrium been reached. For example, the experiment from which the drawing A' is taken showed during a still longer time a continuous sinking of the average blood pressure, so that even 40 seconds after the beginning of the respiration of compressed air it fluctuated between an inspiratory maximum of 98 mm. and an expiratory minimum of 70 mm. From this point the blood pressure rose again. Zuntz is decidedly of opinion that this later change of pressure was not the direct mechanical result of the inspiration of compressed air, but that it was due to the influence of the vasomotor nervous system, which always tends to lower the pressure when by experiment the ventilation of the blood is carried out more completely than under normal conditions, as is generally the case with this mode of respiration, whereas in the converse case it

produces a rise of pressure, both effects, no doubt, depending essentially on the fluctuating tone (tonus) of the arteries in the intestinal region. If during inspiration of compressed air the average arterial pressure should really rise in individual cases, Zuntz considers that this can be accounted for by the effect of the oppression which frequently sets in during the treatment, which leads to severe dyspnoëic irritation of the vascular centre, and thereby to elevation of blood pressure.

In order to arrive at a right estimate of the influence exercised upon the heart and the circulation of the blood, and specially upon the pulse, by increased positive pressure within the thorax, whether produced by the experiment first performed by Valsalva or by inspiration of compressed air, we here present some facts to which Eduard Weber<sup>1</sup> has already called attention.

Weber has discovered that even a moderate effort at expiration with closed air passages causes the heart beat and heart sounds to disappear, and makes the pulse small and less frequent, and he attributes these changes in the circulatory phenomena to the compression of the large venous trunks and the impeded flow of blood to the heart which occurs under these conditions. As these phenomena do not appear in all persons and with every modification of the experiment, it would seem as if individual peculiarities, and especially the manner in which the experiment is performed, were accountable for the most important differences in the various observations.

As regards the changes in the arterial pulse which here specially interest us and its complete extinction during the experiment, they are no doubt due to a compression of the subclavian artery by the strongly raised upper ribs. When, for instance, in Valsalva's experiment, in order to create a strong positive pressure the thorax is brought into a deep inspiratory position, in the subsequent forced expiration only that portion of the thoracic cavity enclosed by movable walls will suffer more or less considerable reduction of size, while the upper part is not contracted in the same manner. But in conse-

<sup>1</sup> Eduard Weber, 'A Process for Interrupting Voluntarily the Circulation of the Blood and the Function of the Heart,' *Archiv für Anatomie und Physiologie*, 1851.

quence of this the danger of compression of the subclavian artery has become imminent, and this circumstance may serve to explain a series of differences which occur in the various observations and especially in the sphygmographic examinations of the arterial pulse during Valsalva's experiment, as well as during inspirations of compressed air. (Cf. here the curve in fig. 51.)

Waldenburg appended to his investigations upon the influence of compressed air on the heart and the circulation sphygmographic experiments, according to which the lateral pressure in the arteries was increased during inspiration; the pulse wave, at first large, soon became very small, and even extraordinarily so, yet nevertheless remained full, and the tension in the arteries was increased. Waldenburg endeavours to reconcile the contradiction that exists between the experiments on animals and his observations and deductions by the statement that the former had no reference to the tension of the arteries, but solely to the blood pressure. Waldenburg thinks it quite possible that the increase of peripheral resistance and the abnormal fulness of the arteries are sufficient in themselves to raise the arterial tension, even when the blood pressure is not elevated or is even somewhat lowered. Waldenburg is of opinion that in observations on the human subject arterial tension and fulness are far more important than blood pressure, as the latter may decrease although the cardiac force is strengthened, if the peripheral vascular area becomes widened to a greater degree than the action of the heart becomes stronger. The increased cardiac force would then be more than compensated by the dilatation of the bloodvessels.

We learn, however, how difficult the examinations of such conditions are from the sphygmographic labours of Riegel and Frank, who, in their careful investigations as to the influence of compressed air on the heart and the circulation, could arrive at no completely satisfactory result. They distinguish two different, opposed phases of the influence of altered air-pressure, a primary initial and a secondary terminal influence, in which, though they look upon the primary action as by no means unimportant, they lay the greater weight on the secondary one. With regard to the subsequent changes in the pulse, the results

of the sphygmographic investigations of Riegel and Frank are in accordance with the results of the kymographic investigations of Ducrocq, Drosdoff, Botschetschkaroff and Zuntz, while they stand in opposition to the results of Waldenburg's researches, and only the primary action partially confirms Waldenburg's assumptions.

During the inspiration of compressed air of  $\frac{1}{40}$  atmosphere excess of pressure they obtained in different persons the variations of pulse expressed in the following tracings, which they also confirmed by a series of controlling experiments on one of themselves (fig. 46).

The first five pulsations represent the normal pulse; after the commencement of inspiration the plate was again set in motion; the two next succeeding pulsations are distinguished by very rapid descent of the down stroke, which reaches the base of the curve, and by a very marked dicrotic wave with



FIG. 46.

faintly indicated secondary wave of elasticity. The frequency is very slightly increased; from the third pulsation onwards it diminishes considerably; the height of the pulse wave, on the other hand, increases considerably; the dicrotic wave remains very evidently maintained and becomes somewhat higher; at the same time the lower part of the line of descent lengthens very decidedly, while the secondary wave of elasticity, only faintly indicated in the normal part, stands out very sharply.

According to Riegel and Frank the first pulsations, occurring at the commencement of inspiration, indubitably point to a lowering of the vascular tension; on the other hand, in the second section the strongly marked dicrotism contrasts remarkably with the greater prominence of the secondary elastic wave, and the investigators despair of a more exact analysis of these variations.

In accordance with these sphygmographic investigations



Sommerbrodt also found during inspiration of compressed air, by using a sphygmograph of his own invention, relatively great dirotic elevation in all parts of the curves drawn by him, together with what, in most of the separate curves, he also observed, strongly marked secondary oscillations and fluctuations due to elasticity, also strong primary elevations when inspiration was complete.

The curves taken by Sommerbrodt<sup>1</sup> (in fig. 47) give a tolerably exact representation of the processes, as they are developed in the human being during the inspiration of compressed air.

The first up-stroke represents a specially good normal pulse wave. Then comes the inspiration of compressed air of an excess of  $\frac{1}{50}$  atmosphere pressure, carried out not slowly and passively, but actively by the person under experiment. Exactly corresponding to the theoretic presuppositions there is

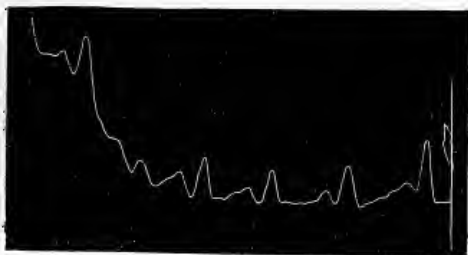

FIG. 47.

marked on the three next pulse waves, first, the influence of the ordinary powerful inspiration with which rarefaction of air in the lungs is combined, i.e. the blood pressure sinks; the dirotic waves become deeper and the waves of elasticity less frequent. As already mentioned, the mercury at the beginning of inspiration first sinks rapidly and deeply in a manometer which is inserted between the mouthpiece and the pneumatic apparatus, and in which the level of the mercury corresponds to the air pressure in the apparatus, even to the ordinary atmospheric pressure, and then rises and assumes at the end of the inspiration a level corresponding to the compression of air employed. The sinking of the blood pressure in fig. 47 exactly answers to the stadium of the sinking of the manometer by the rarefaction

<sup>1</sup> Sommerbrodt's curves must be read from right to left.

of air in the bronchi at the beginning of a forced inspiration. After the fourth pulse wave, therefore after the fall of the blood pressure, it begins to rise considerably under the influence of the compressed air which has meantime streamed in, and now has come into action, with simultaneous diminution of the negative pressure of the lung upon the heart and the intrathoracic vessels. The pressure on the arteries amounted in this case to 290 grammes.

When in contrast to this energetic inspiration, inspiration is slow and cautious, then the stadium of sinking blood pressure may be almost completely eliminated, and sphygmographically the pulse waves altered by the rise of blood pressure immediately succeed to the average normal ones. That in this case the action of the heart is not lowered but raised is clearly seen by the considerable height of the lines of ascent (fig. 48). The

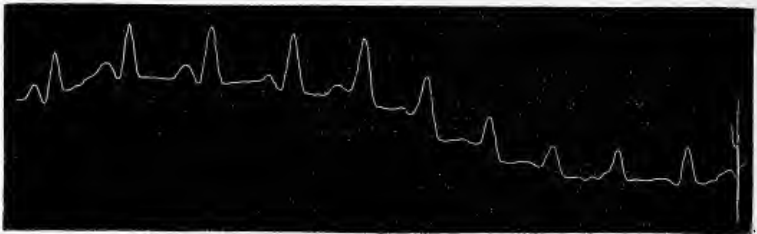

FIG. 48.

compression pressure of the air in this case amounted to an excess of  $\frac{1}{30}$  atmosphere, the pressure on the arteries to 320 grammes.

At the same time Sommerbrodt remarked an elevation of the curve during inspiration and a depression of it during expiration, in opposition to the normal conditions, in which the curve falls in inspiration.

These last conditions are very well shown in the two following curves (figs. 49 and 50), of which the upper one was traced under the influence of the inspiration of compressed air and the other in normal breathing—not, however, in the same person. Both contain two complete phases of inspiration and expiration, which, however, show in a highly characteristic manner two movements running in opposition to one another.

Sommerbrodt has also shown in this as in a series of other

curves that in prolonged inhalations the frequency of the heart's contraction, at first slightly diminished, increases very materially, and he therefore believes that during inhalation there is an engorgement of blood in the systemic veins by which decarbonisation is diminished. From this point of view he also sees in the pulse curves the signs of increased vascular tension in consequence of the increased resistance which the arterial blood wave encounters. As regards the height of the dirotic wave, which, according to Riegel and Frank, appears opposed to the occurrence of the waves of elasticity, Sommerbrodt, after thoroughly weighing the mechanical influences here at work, narrowing of the blood canals and energetic contrac-

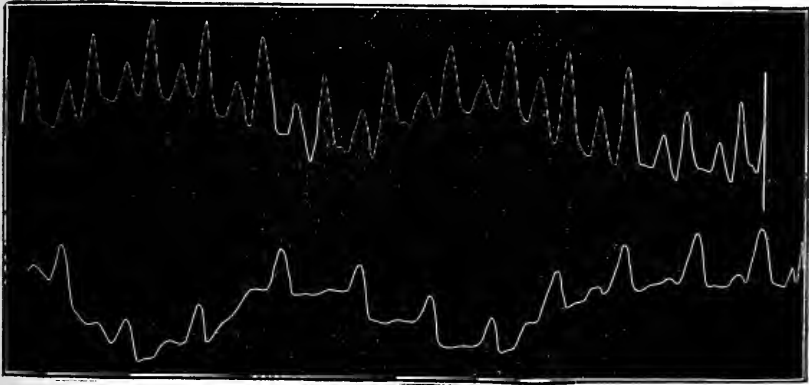

FIGS. 49 and 50.

tion of the ventricle from decrease of the negative pressure of the lungs on the heart, tries to prove that in the simultaneous presence of signs of strong vascular tension and dirotism in the cases before us no contradiction is to be seen, but only logically concordant phenomena.

Waldenburg has called attention to the fact that there is a certain degree of compression of air which in its final effect is capable of producing a very great diminution of pressure in the arterial system. Riegel and Frank further found that a very marked diminution of pressure in the arterial system may also be exceptionally observed in cases in which, owing to a predisposition in the vascular system which could not be anticipated, only a slight compression of air has been employed.

Fig. 51 represents the pulse curves of a convalescent 17 years old, who, by reason of a very great power of expanding the thorax in respiration, was able to carry out very prolonged and unusually deep inspirations. The curves *a-b* represent the normal pulse; the curves after *b* represent the pulse changes under the influence of an excess pressure of  $\frac{1}{30}$  atmosphere, and here it was not till a short time after the beginning of inspiration that the lever was set in motion. In

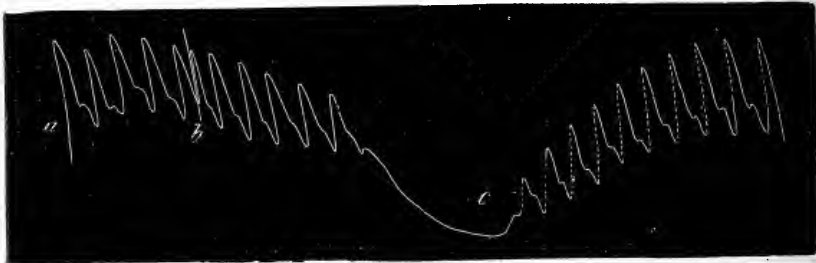

FIG. 51.

this part of the curve the increase and then the complete suppression of the pulse is exhibited in a very striking manner by the gradual depression of the whole curve, as well as by the rapid and continuous diminution of the pulse stroke up to its entire disappearance, so that at the close only an oblique line running downwards is drawn. About at *c* the inspiration ceased



FIG. 52.

and expiration into the ordinary atmosphere began. We have already above given the explanation of this phenomenon.

We have already, in treating of the influence of air pressure on the respiration, called attention to one of its more permanent effects, and at the same time to the circumstances resulting from it, viz. increase in amount and density of the complementary air in the lungs. A similar after effect must also therefore be exercised upon the circulatory apparatus, because in the

first place the increase of pressure extends to expiration, and secondly, after the close of inspiration of compressed air it is some time before the relations of density between the outer and the pulmonary air become re-established. The first kind of after effect has been demonstrated by Sommerbrodt in a series of tracings (No. 52), viz. that the influence exerted upon heart and vessels in inspiration is to a great extent prolonged into the expiration, and thus a continuous action is produced.

The second kind of after effect can be also graphically represented, viz. the duration of the influence up to the time when the respiration has returned to the normal. In fig. 53 Sommerbrodt gives the pulse curves of a young man, drawn two minutes after eight inspirations of compressed air ( $\frac{1}{4\frac{1}{2}}$  atmosphere); pressure 290 grammes. In this curve an excessive dirotic wave is still found only in one place, all the others



FIG. 53.

being lower than the normal, and the oscillatory and elastic waves are diminished in comparison with the other curves of the inhalation; the frequency is still slightly increased, but the percussion strokes are very high, and the tidal waves short and energetic. The last point is particularly well illustrated by the fact that fig. 53, in spite of a pressure of 290 grammes, shows a curved line rising as high as another tracing from the same young man with a pressure of only 260 grammes.

Lastly, we have to notice the latest experiments of Schreiber,<sup>1</sup> in whose tracings (fig. 54) during long-continued inspirations under  $\frac{1}{40}$  atmosphere pressure three stages may be distinguished: viz. at the beginning of inspiration of compressed air (indicated by an arrow) an increase of the average pressure, next a decrease to below the normal, and lastly an adjustment of the pressure, which, however, fails to reach the former normal

<sup>1</sup> Schreiber, 'On the Influence of Respiration on Blood Pressure,' &c., *Arch. f. experiment. Pathol.* x. 1, 2; xii. 2, 3. Leipzig, 1878 and 1880.

average height. The changes in the lines of ascent which show that the pulse first rises higher, then falls below the normal, and finally rises to the average height, are not quite parallel with these three stages. At the same time the tension of the artery is very much increased in the first stage, diminishes gradually in the second and third, but appears at the close, as Riegel and Frank's tracings also show, to increase again by stronger predominance of the waves of elasticity. The frequency shows a slight retardation prolonged into the second stage, and afterwards a slight gradual acceleration up to the end of the third stage.

The sphygmographic tracings of Schreiber, of Riegel and Frank, and partly also those of Sommerbrodt, do not diverge very much in essential points from the previous kymographic investigations, but they differ considerably from Waldenburg's observations. The pulse, as we have already said, at the



FIG. 54.

commencement of inspiration becomes strong and full; subsequently, on the other hand, it gradually gets smaller, owing to the reduction of the quantity of blood in the lungs; the tension of the arteries is diminished and does not rise again till at the close of the inspiration, in consequence of dyspnoëic excitement of the vasomotor nerves without actual rise of pressure in the arteries. The varying influence of the inspiration of compressed air on the decarbonisation of the blood is answerable for the variation in the frequency of the pulse, which at the beginning of inspiration is diminished, and then as the channels of the pulmonary blood-stream contract, if the experiment lasts long enough, rises again.

The differences which these and the following statements show still to exist between individual experiments and theoretical considerations, will doubtless soon be removed by further careful investigations.

Connected with the kymographic and sphygmographic examinations of the questions we are considering are the later experiments which Waldenburg has carried out by means of the angiometer (*Pulsuhr*) which he has constructed, and which are considered to confirm his former researches and deductions.

At the very first inspiration of air compressed to an excess of  $\frac{1}{40}$  atmosphere pressure the arterial tension rose 20 grammes in the person under experiment (Student M.), and continued to increase till after inspiration of a cylinderful (about 40,000 cubic centimetres) of compressed air the increase reached 45 grammes = an increase of pressure of 82·8 millimetres mercury.

In the same case the diameter of the arteries, during the inspiration of a cylinderful of air compressed to an excess of  $\frac{1}{40}$  atmosphere, increased by 0·38 millimetre. This is equal to an increase of fulness of  $\frac{2 \cdot 0\cdot38}{4\cdot14} = 18\cdot36$  per cent. of the original capacity.

Finally, as regards the influence of the inspiration of compressed air on the size of the pulse, Waldenburg remarked generally that at the beginning of each inspiration there was a single pulsation of greater height, i.e. 0·05 instead of 0·04 millimetre, then a lowering of the following pulsations (0·03 millimetre).

Waldenburg, who has unfortunately died since, had not yet arrived at any definite conclusion as to the result of his experiments on the changes of blood pressure during the use of compressed and rarefied air, and was reserving this question for further investigation.

Observations on pulse frequency have not led to any harmonious result. The results which Waldenburg obtained in investigating the influence of compressed air on pulse frequency were not so constant and marked as the other changes in the vascular system. He found for the most part during the inspiration of compressed air, especially with healthy persons and with a high degree of air compression, the pulse frequency somewhat retarded; in other cases he failed to observe any reduction of pulse frequency, or it even appeared to be increased by perhaps a few beats. Schnitzler, in opposition to Waldenburg, was not able to observe any changes of

pulse frequency during inspiration of compressed air, while Ducrocq, Riegel and Frank, and others have observed chiefly a variable behaviour of the pulse. The decrease in the rapidity of the circulation, which is regulated wholly by the need for the supply of oxygen and for the excretion of carbonic acid in the nervous system, is accounted for by the complete oxygenisation and decarbonisation of the blood during inspiration of compressed air, and when an acceleration of the circulation takes place we must refer it to the above-mentioned interference with the pulmonary circulation.

All the phenomena of the pulse and in the veins just described, which may be recognised by inspection, palpation, and auscultation, as well as (according to Sommerbrodt) by the graphic representation of the pulse curves, extend to the expiratory phase, and therefore are maintained during the intervals of the inspiration of compressed air. Certainly Waldenburg observed on very close examination differences in the intensity of the several phenomena during inspiration and expiration, but never phenomena so different as to indicate opposing influences. The pulse remained tense and full, sometimes larger during expiration than towards the end of inspiration, and the height of the pulse wave was sometimes unchanged, at others somewhat diminished. The veins were equally swollen in inspiration and expiration, the cardiac sounds in the same way intensified. Waldenburg thus explains theoretically the duration of the influence during expiration; the increased quantity of air conveyed to the lungs by inspiration of compressed air has to flow out through exit tubes not in any way enlarged. This, he says, must necessarily have the same effect as if expiration had been made into compressed air after ordinary inspiration (cf. *infra*). At any rate anyone may produce the same effect by expiring quickly and deeply, or on the other hand weaken it by slow expiration. Knauthe accounts for this duration in this manner: the expiratory pressure, which in itself under normal respiration is rather positive than negative, with its action raising the blood pressure in the aortic system proportionally to that effected by inspiration of compressed air, must also rise to an almost positive inverted inspiratory pressure. We ourselves have repeatedly



had occasion to express our view of these phenomena, which are exactly what we have a right to expect according to physico-mechanical relations of the respiratory processes which are here altered. Cf. here also fig. 45, A.

As to the length of time during which the after effect of the methodical inspiration of compressed air may be observed, according to Waldenburg it lasts from half an hour to an hour, and it is probable that with frequent use the effect would be more and more permanent. Waldenburg frequently observed, especially in sufferers from heart complaints, a permanent increase in the tension and fulness of the pulse, so that the after effect of the previous sitting was not yet ended when the following one began. If the treatment was carried on long enough, these symptoms could be observed for weeks and months. In the cases which I have observed the after effect was generally only brief and transient; I have never observed an after effect prolonged to the next sitting.

Waldenburg considers it possible, without advancing any strict proof of it, that by this long-continued inspiration of compressed air not only is the disordered circulation temporarily regulated, but the cardiac muscle also is permanently strengthened; as every other muscle increases in strength and volume by daily methodical exercise, the same may be expected of the cardiac muscle. The influence also of the increased intra-pulmonary pressure, exciting the heart mechanically to stronger contractions, and therefore to greater activity, and thus inducing a regular and methodical daily uniform gymnastic exercise of the cardiac muscle, must strengthen its structure and action. Whether the cardiac muscle can increase in volume, so as to become gradually more or less hypertrophic, remains undecided. At any rate the tendency of the cardiac muscle to a compensatory hypertrophy, especially where a natural propensity in that direction is recognisable, would be thus encouraged, just as already existing compensations might be regulated by the pneumatic method. Waldenburg advances in support of his hypothesis (1) the permanent increase of pulse tension which he professes to have repeatedly observed; and, (2) as connected with it, his remarkable and permanent therapeutic successes. In some cases he was even able to

ascertain by percussion an extension of the cardiac dulness. These appearances, however, always presupposed a lasting increase of cardiac power, which most probably would affect the muscular tissue of both sides of the heart and the ventricles and auricles equally.

The theoretic conclusions of Waldenburg have not; however, been accepted by other observers. Schnitzler, who has not hitherto observed any special advantage resulting from mechanical treatment in heart complaints, in which I quite agree with him, nevertheless recommends it in cases which appear suitable, as this method not only rests on a scientific basis, but also frequently procures a real, though not always a permanent, alleviation. Although he himself has not in his cases witnessed that constant influence over circulatory disturbance, yet he often succeeded, by administering condensed or rarefied air in various heart complaints, in relieving considerably certain distressing symptoms, especially agonising dyspnoea (cf. also Hänisch on the indications in the therapeutic section).

## 2. *Expiration into Compressed Air.*

When in expiration the expired air meets denser air under a high pressure, it receives a partial check, expiration is impeded, and intra-thoracic expiratory pressure is increased to an amount which must influence the heart and the vessels in the same way as the increase of pressure in the lungs by inspiration of compressed air. The degrees of pressure of the air employed do not, however, exert the same influence in the two methods, but slighter condensations of the air into which expiration takes place produce the same effects on the heart and the circulation as a greater compression when the air is inspired.

The mechanical influence exercised on the heart and the vessels by Valsalva's experiment, in which, as is well known, after a deep inspiration a forced expiration is made with mouth and nose closed, corresponds essentially with those accompanying expiration into compressed air. Therefore the changes observable in the heart and vessels during expiration into compressed air will necessarily resemble those that attend Valsalva's experiment; while, on the other hand, they will be found to

differ only in degree from the phenomena which we have observed to accompany the inspiration of compressed air.

The pressure in the aortic system is at first increased, the arterial walls are distended, and the outflow of blood from the veins into the right auricle is checked, so that under the increased intra-thoracic pressure a large quantity of blood is driven into the aortic system in the first systole. During the subsequent contractions less and less blood is conveyed to the heart, and the arteries themselves are no longer capable of discharging the excess they have already received, into the capillaries and veins. Thus the result of this mechanical influence is here also an unequal distribution of blood in the organism, there is less blood in the lesser circulation and the intra-thoracic organs, while the systemic circulation and especially the veins are over-full.

As the intra-thoracic changes of pressure resulting from impeded respiration find their simplest expression in Valsalva's experiment, so the phenomena which are to be observed in the vascular system during its performance will be most instructive in elucidating the other complicated processes.

We have before us sphygmographic examinations of the arterial pulse in connection therewith by Waldenburg, and subsequently by Riegel and Frank, Sommerbrodt, Knoll and Schreiber. The tracings which were obtained by Riegel and Frank with Marey's (spring-action) and by Sommerbrodt with his own apparatus, constructed on another principle (pressure), as well as those of the other authors, do not differ from one another in any essential points.

The tracings (fig. 56 of Riegel) show in the first place two different forms of curve, the first of which unmistakably represents increased vascular tension. The curve rises strongly above the level of the base line; the dicrotic waves, before relatively deep, become flatter; the boundary between the first high-lying pulse waves becomes sharper, the oscillations and elastic fluctuations more numerous, the pulse frequency diminished. After a few pulse beats, however, the type changes; the dicrotic waves increase considerably in size, and in Riegel's curves reach about a third of the actual pulse wave. The pulse becomes exquisitely dicrotic and hyperdicrotic; the elastic

elevations, on the other hand, become considerably less evident, or disappear altogether. Riegel and Frank conclude from these secondary changes of the pulse, which they consider the most important results of Valsalva's experiment, that there is a considerable lowering of the arterial tension, in which they are opposed to Sommerbrodt (fig. 55), who, as already stated, refuses to see in the phenomenon of dirotism in these cases any contradiction of the signs of increased vascular tension.

Knoll, who took the pulse-tracing and the respiratory tracing together during the whole duration of the compression of air in the thorax, as well as before and after it, obtained in con-

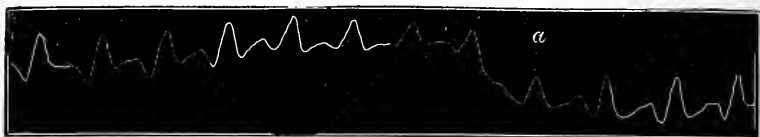

FIG. 55.



FIG. 56.

tradistinction to the above experiments the following results (fig. 57 A, B):—

Immediately after the beginning of a powerful expiratory movement, while the thorax is kept in the inspiratory position and the mouth and nose closed, a considerable rise of the arterial curve took place (at *a*), and the several pulsations, generally somewhat less frequent and smaller, showed the signs of very much increased arterial tension. After this the series of curves sank (at *b*), while the several pulsations became considerably smaller; the pulsations were accelerated, and the depressed position and the great widening of the dirotic wave now pointed to a considerable diminution of arterial tension. After that the gradual rise of the series of curves again set in, while the pulsations, still remaining small, were accelerated lastingly, and for the most part considerably (12 to 16 beats in

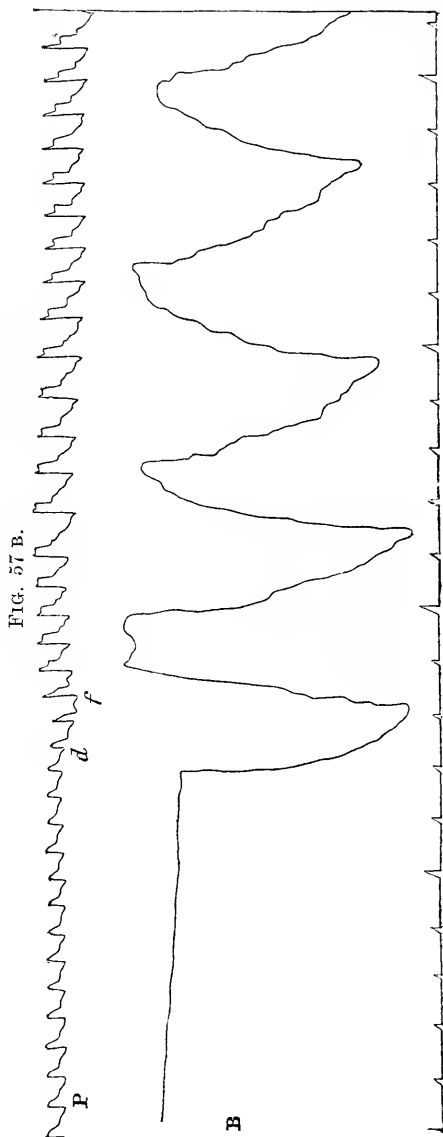
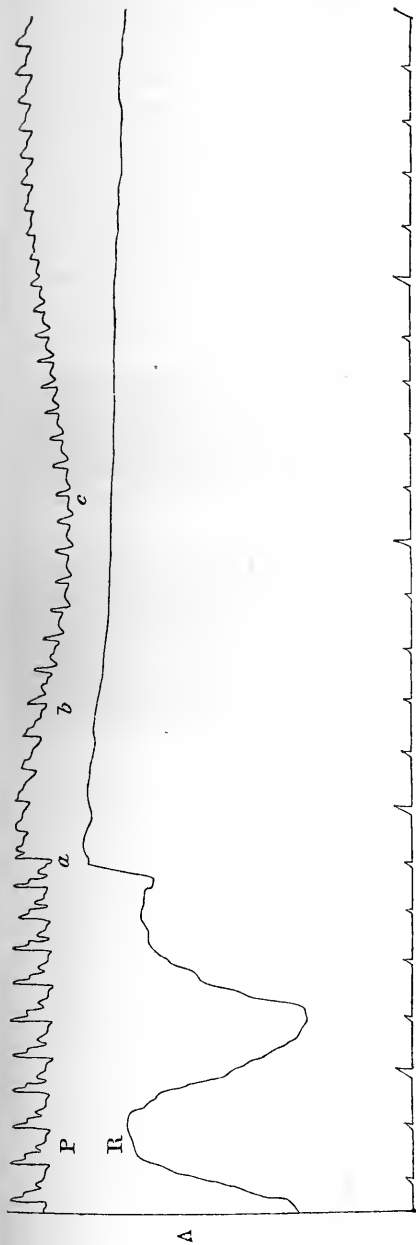

the minute), and again the several curves showed the signs of increased arterial tension, which was maintained till the close of the experiment. As soon as the mouth and nose were opened, the curves (*d*) fell considerably during 2 to 3 pulse beats, while at the same time a diminution of the arterial tension was observable, but immediately rose again (*f*) during the first free respiration, accompanied with all the signs of increased arterial tension. The pulse in this case had generally become larger and less frequent than before the beginning of the experiment.

Knoll tries to account for the changes which are observable during his experiment by the conditions introduced by this modification of the respiratory movement.

The diminution of the pulse curves is the result of the decreased flow of blood to the heart, and the initial rise of arterial pressure to the pressing of blood out of the thorax. So soon, however, as this last force is exhausted, the reduction of the supply of blood to the arterial system caused by decreased filling of the left ventricle must bring on a diminution of the arterial tension, which is more or less compensated later on by the dyspnoëic excitement of the vasomotors, and partly also no doubt by the acceleration of the heart beat. Now at the moment when the confined air suddenly escapes from the thorax an actual suction of blood into the thorax must ensue, which for the period of 2 to 3 pulse beats produces a decrease of tension in the arteries. As soon, however, as these violent fluctuations are balanced the contraction of the small arteries caused by the dyspnoëic character of the blood will again make itself observable in the pulse curve, till the blood becomes eupnoëic, while on the other hand the free flow of the blood, dammed up in the veins, towards the heart will lead in the first place to an increased filling of the heart with blood, and consecutively to an increase of arterial tension with synchronous amplification of the several pulse waves.

When after inspirations of compressed air not only the quantity of air, but also the pressure under which it stands, is increased in proportion to the degree of condensation applied, and expiration into ordinary atmospheric air follows, then the respiratory pressure upon the heart and the veins, which is not negative even in normal breathing, as has been already shown, must increase to an extent which will exercise

the same influence on the pulmonary surface as that of expiring into compressed air after ordinary respiration. The changes which are thus induced in the arterial pulse have been already reproduced by Sommerbrodt, and we have also mentioned that it is to this, the effect of pressure lasting after expiration, that the continuous action in the inspiration of compressed air is to be attributed. Sphygmographic examinations of the pulse during expiration into the compressed air also show clearly the concordance of the theoretically presupposed changes. Figs. 58 and 59 give the pulse curves taken by Riegel during expiration into compressed air, in which the first tracings are



FIG. 58.



FIG. 59.

taken during the period before the experiment, whereas the first pulsations occurring during expiration are missed as they happen while fixing the plate. In the normal part the dicrotic and elastic waves are clearly marked; as soon as the influence of the increased pressure in the lungs begins the curve here again rises considerably above the level of the base line. The dicrotic wave (fig. 58) stands lower, is more developed, and terminates in an acute angle; at the same time the terminal part of the line of descent is prolonged and the second, elastic wave is well marked. In the following curves the dicrotic wave sinks still lower, while the terminal part becomes considerably shorter and the second elastic wave becomes less

and less distinct; it represents an excessively dicrotic pulse, which becomes hyperdicrotic in fig. 59. The frequency is somewhat less in the first moment of expiration, but afterwards increases considerably; the size of the pulse diminishes only slightly.

If we compare this tracing with those which were taken during Valsalva's experiment, the analogy of the changes in the vascular system is evident. In both experiments the curve rises at the beginning of the expiration, while the dicrotic wave is at first only slightly altered and the elastic waves are very well marked. These changes may be attributed to an increase of lateral pressure in the arteries. In the later stage the dicrotic wave is always more developed, and the pulse becomes dicrotic and hyperdicrotic. The elastic waves disappear, and an unmistakable decrease of the lateral pressure and a diminution of the arterial tension now set in. Riegel and Frank are inclined to attach the highest importance to these secondary changes, both in Valsalva's experiment and in expiration into compressed air. These pulse-tracings are in accordance with those taken by Schreiber.<sup>1</sup>

Waldenburg found in his experiments with the angiometer (*Pulsuhr*), in accordance with his own theory, already developed, but in opposition to the sphygmographic investigations of Riegel-Frank and Schreiber, that arterial tension as well as arterial fulness was increased in a high degree. In the person examined (the medical student M.) the increase of tension amounted to 35 grammes, i.e. equal to an increase in pressure of 64.4 millimetres mercury. The arterial diameter increased by 0.37 millimetre and the arterial fulness by  $\frac{2 \cdot 0.37}{3.14} =$  about 18 per cent.

After one single large pulsation of 0.05 millimetre at the beginning of the expiration, the pulse very rapidly got smaller down to 0.01 millimetre, and at last almost wholly disappeared, so that only a trembling of the pointer was observable when the experiment was carried out with vigour.

But Waldenburg was also able to prove the opposite phenomenon, decrease of pulse tension and arterial fulness, in

<sup>1</sup> A. a. O. S. p. 127.



a series of cases in which, at the beginning of Valsalva's experiment, the pointer, instead of receding, advanced still farther forward and showed that the arterial tension, instead of increasing, diminished; the arterial diameter also decreased instead of increasing, as usually occurred. Waldenburg attributed these abnormal results to compression of the subclavian artery, before it escaped from the thorax, by increase of the intra-pulmonary pressure. Such a compression of the subclavian artery had been frequently observed before by physiologists, and brought forward to explain the disappearance of the pulse in Valsalva's experiment. Waldenburg, however, insists that this effect on the subclavian artery is not to be regarded as the regular, but only as an exceptional result of the increase of air pressure in the lungs. A persistence of the pressure action and the phenomena in the vascular system consequent upon it during the inspiration of normal air also obtains during expiration into compressed air, and can be detected by direct observations on the pulse, the heart, and the veins. On account of the incompleteness of expiration into compressed air, a certain quantity of strongly compressed air remains behind in the lungs, which expands during the ensuing inspiratory dilatation of the thorax and is also added to by the fresh air inspired. For this reason the normal rarefaction of air in the lungs found at the beginning of inspiration cannot exist, and the negative pressure will suffer a reduction which is identical with the effect of the inspiration of compressed air of a determined degree of condensation. The mechanical influence of expiration into compressed air is therefore to be regarded as continuous, not intermitting.

We have as yet no reports on the duration of the after-effect after the close of the experiment, as expiration into condensed air has not yet been methodically employed for therapeutic purposes.

### 3. *Inspiration of Rarefied Air.*

The mechanical effect of the inspiration of rarefied air on the heart and the vessels must be the opposite of that which results from the inspiration of compressed air, and may be

deduced theoretically from the changes in the mechanism of the respiration and circulation which that brings about.

By the lowering of the intra-thoracic pressure and the resulting suction action upon all the thoracic organs during the inspiration of rarefied air, the contraction of the cardiac muscle in systole is interfered with, and the pressure in the aortic system thereby diminished, though not to a measurable extent. On the other hand, the diastole, the flow of blood from the veins into the right auricle, is facilitated, and the thoracic organs and both auricles and ventricles, as well as the pulmonary circulation, receive more blood than before, so that a larger amount of arterialised blood is also carried into the systemic circulation. The final effect of these changes will be that the arteries of the greater circulation must become more and more filled with blood, the pulse increased in size and fulness, and its frequency, which is dependent on the quantity of blood which flows into the aortic system and on the absorption of oxygen and its influence on the respiratory organs, either only slightly altered, or with higher degrees of rarefaction of air it will be increased.

We possess as yet but few direct observations on the changes in the vascular system during inspiration of rarefied air, and they are limited to a few sphygmographic tracings and Waldenburg's later investigations with the angiometer (*Pulsuhr*).

As there is an analogy between expiration into compressed air and Valsalva's experiment, so there is also between inspiration of rarefied air and Müller's experiment, in which, after complete closure of mouth and nostrils, forced inspiration is made. On the other hand, the mechanical effect of inspiration of rarefied air on the heart and vessels coincides with expiration into rarefied air, which is almost exclusively utilised for producing therapeutic effects by negative pressure. As the action of both methods is almost identical and only differs in degree, we shall return to the changes resulting in the vascular system when examining the influence of expiration into rarefied air, and compare further concordant researches with our theoretical forecasts.

In the sphygmographic investigations of the changes in the

pulse during Müller's experiment, Riegel and Frank failed to obtain absolutely identical results, nor did they observe such remarkable changes as in Valsalva's experiment. Riegel attributed this failure partly to the fact that the success of the experiment presupposes a considerable amount of skill on the part of the person under experiment; but even in cases in which the individuals carried out the experiment in a perfectly satisfactory manner no particularly remarkable changes of pulse were observable.

As soon as the experiment begins—i.e. so soon as, mouth and nose being closed, a forced inspiratory dilatation of the thorax is made—the writing lever takes a somewhat lower position (fig. 60); the pulse curve sinks below the level of the base line, and then returns gradually to nearly its original height with the rising of the lever. The changes in form of the several pulse waves run parallel with these fluctuations of the



FIG. 60.

writing lever; synchronously with its depression the dicrotic wave descends lower and becomes more marked, but in its further course it is somewhat less pronounced; the summit of the curve becomes somewhat higher and the frequency of the pulse increases; the waves of elasticity are on the whole less marked.

These changes in the curves in Riegel's experiment indicate unmistakably a slight lowering of lateral pressure and a diminution of tension in the arteries; on the other hand the higher rise of the curve later on, as well as the greater distinctness of the waves of elasticity while the dicrotic wave is relatively smaller, speak in favour of the hypothesis that a secondary though inconsiderable vascular tension occurs. And the higher rise of the first elastic wave, as observed by Riegel, can only be interpreted in this sense.

Knoll obtained the following results with Müller's experiment (fig. 61 A and B):—

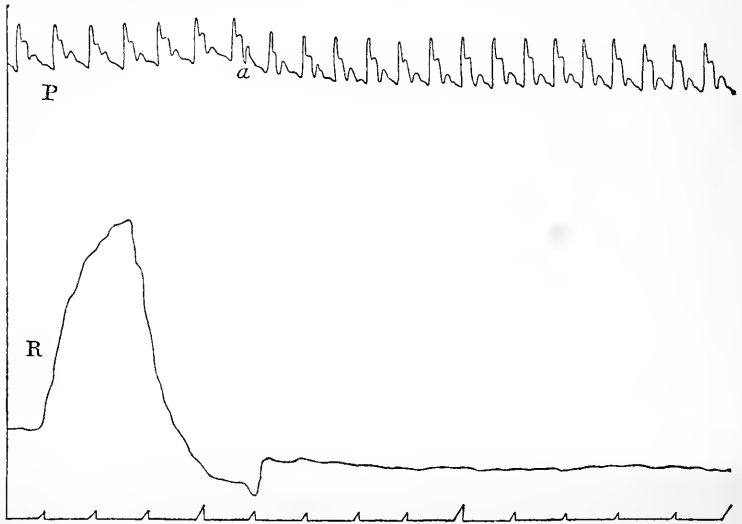

FIG. 61 A.

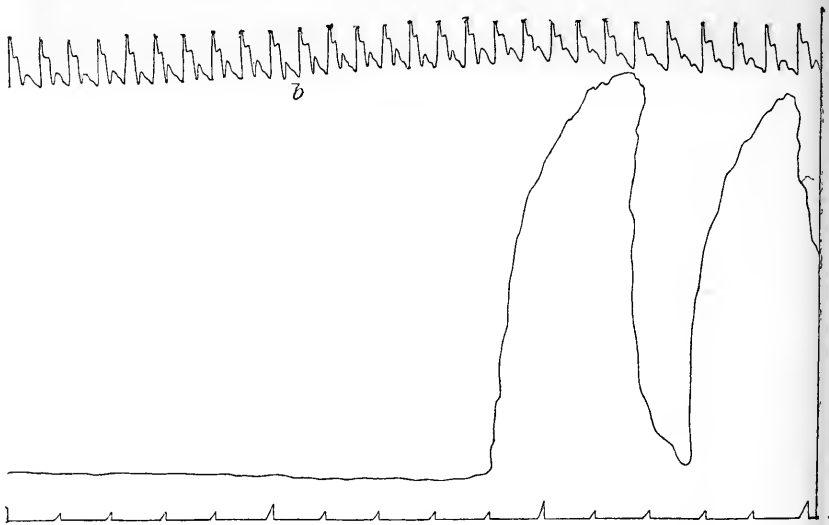

FIG. 61 B.

When he caused mouth and nose to be closed at the end of a deep inspiration, and immediately the thoracic space to be

powerfully dilated, avoiding elevation of the upper ribs as much as possible, and kept it dilated for some time as uniformly as possible, the pulse curves, when the experiment had lasted some time, generally became larger (*a*). The series of curves sank at the beginning of the inspiratory movements, and the dicrotic wave in the line of descent of the several curves was depressed and generally much more marked; in the further course of the experiment (*b*), however, the series of curves rose again, the dicrotic wave became smaller and approached nearer the apex of the curves. After the experiment was over the several pulse curves during the first free respiration bore signs of higher arterial tension.

If we glance at the complete series of curves, we see at once at the beginning of the pulse curve how the difference in the atmosphere pressure to which the intra-thoracic and extra-thoracic vessels are exposed during the experiment leads to a diminished fulness of the extra-thoracic vessels, and therefore also of the radial artery. But immediately, in consequence on the one hand of the accelerated flow of venous blood to the heart, and on the other of the accelerated flow of blood out of the dilated lungs and the aid which the diastolic expansion of the heart derives from the high negative pressure in the thorax, the left ventricle becomes highly charged with blood, so that the heart at each systole can send out more blood into the arterial system. Although certainly the strong negative pressure in the thorax acts as a check upon the contraction of the heart, yet this check does not count much against the force with which the heart contracts, as Knoll endeavours to show from the size of the pulse curves during the experiment. Since Knoll also found the frequency of the heart beats increased, the explanation seems to be that when respiration, modified in this manner, is prolonged, in spite of the continuance of the differences of pressure above mentioned, the extra-thoracic vessels become more and more filled with blood. Lastly, the gradual increase of arterial tension thus caused will experience a rise later on from the setting in of dyspnoëic arterial contraction, which appears as an after-effect at the very beginning of free respiration.

The pulse curves of Müller's experiment are in all material

points in accordance with Riegel's sphygmographic tracings during inspiration of rarefied air, in which the several experiments could each time be performed with the necessary exactness.

As in Müller's experiment, the curve sinks somewhat at the beginning of inspiration, at the same time the pulse becomes small, the dicrotic wave more distinct, while the waves of elasticity become less marked (fig. 62). Almost immediately afterwards the curve again rises somewhat, and ultimately reaches nearly its original height. It, however, undergoes essential changes in form. In the first place, the first dicrotic wave immediately rises, so that it almost reaches the apex of the curve, and the second, the wave of elasticity, is still clearly recognisable everywhere; on the other hand, the dicrotic wave, strengthened at the beginning of the inspiration, decreases somewhat again in its further course. No remarkable fluctua-

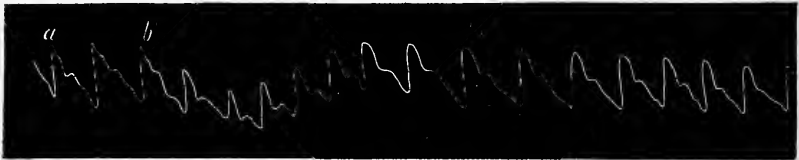

FIG. 62.

tions in the frequency are observable; the primary slight increase becomes equalised after some time.

Here also the transient primary sinking of the lever with the marked dicrotism points to a momentary lowering of arterial pressure, while the later rise of the curve as well as the further maintenance of the dicrotic wave and wave of elasticity confirms the conclusion that there is an increase of arterial pressure.

Riegel has no doubt, from the circumstance that the primary sinking of the writing lever with the other characteristics mentioned above is only temporary, while the further transformations of the curve last through the whole duration of the inspiration, that the chief importance is to be attributed to the latter.

Lastly, Schreiber's tracings are worthy of attention; he obtained the following curves (fig. 63) with  $\frac{1}{10}$  atmosphere pressure:—

From the arrow the base line rises gradually with almost constant increase up to the end of the experiment, although on the whole by a relatively slight ascent. The ascensions become considerably greater from the second pulsation during the experiment on to the end, while the dicrotic wave, distinctly marked low down on the line of descent, rises constantly higher and becomes more and more indistinct. In the same proportion the waves of elasticity, at first not present, become much more distinct in the second half of the inspiration and to the end of the experiment. The pulse during these changes in the circulatory apparatus must therefore be described as full, large, and hard, the size of the pulse depending on the average pressure prevailing in the artery at the time.

In considering the difference between Waldenburg's theoretical deductions and the preceding sphygmographic investigations we must call attention to the later experiments of this



FIG. 63.

author, in which, by means of the angiometer (*Pulsuhr*), he found the changes in the vascular system fully supported his hypothesis. Both during Müller's experiment and during the inspiration of rarefied air the tension in the arteries and the arterial fulness diminished considerably, the amount being in the case of the same person—

(a) In Müller's experiment: decrease of tension 35 grammes, which corresponds to a diminution of pressure of 64.4 millimetres mercury; the arterial diameter was reduced by 0.32 millimetre, therefore the arterial fulness by  $\frac{2 \cdot 0.32}{3.14} =$  about 15.5 per cent.

(b) After one single inspiration of air rarefied by  $\frac{1}{10}$  atmosphere pressure the tension fell 20 grammes = 36.8 millimetres mercury, and after 6 to 8 inspirations the arterial diameter was

reduced by 0.35 millimetre, therefore the arterial fulness by  $\frac{2 \cdot 0.35}{3.14} = 17$  per cent.

As regards the size of the pulse, Waldenburg observed in Müller's experiment at the beginning of the dilatation of the chest 1 to 2 large pulses (0.05); then the pulse became smaller and smaller down to 0.01, and with very long-continued inspiration only a trembling could be observed, a distinct pulse was no longer visible.

In inspiration of rarefied air the height of the pulse waves was, at the beginning of the experiment, only slightly raised (about 0.01 mm.) in some pulse beats; it then diminished, and during the further course remained small (0.02).

The lowering of the intra-thoracic pressure by inspiration of rarefied air acts also lastingly on the expiration, as the pressure exercised on the heart and the vessels during expiration, owing to the considerably greater dilatation of the lungs with disproportionately less air admitted, is also diminished, so that here also the pressure action is continuous, not intermitting.

We have no observations either of Waldenburg or other authors as to the duration of the mechanical after-effect after the close of the experiment, as hitherto only expiration into rarefied air has been employed in diseases of the respiratory tract instead of inspiration of rarefied air.

Waldenburg was of opinion that these inspirations were specially indicated in diseases of the right side of the heart, but no such patients had come under his treatment; he thought that by the inspiration of rarefied, as by that of compressed air, a permanent increase of cardiac force and even a compensatory hypertrophy of the cardiac muscle might be induced, especially as a gymnastic exercise of the cardiac muscle might be attained by the abnormal resistances which are opposed to its contraction.

Further observations are still wanting.

#### 4. *Expiration into Rarefied Air.*

As we have already mentioned, the changes in the circulatory organs during expiration into rarefied air are analogous to those which have been observed during the inspiration of



rarefied air. Waldenburg was of opinion that the difference between the two methods lay in the amount of the mechanical effect, and attempted to prove that inspiration of rarefied air produced phenomena of a more marked kind in the vascular system. That part of the negative pressure which is due to the elasticity of the lungs is diminished in expiration into rarefied air; accordingly the effect upon the circulatory organs will be that much the less than in inspiration of rarefied air, i.e. the difference of the coefficient of elasticity between deep inspiration and forced retraction. This difference in the effect of the two methods can, however, be entirely balanced by the application of a stronger degree of negative pressure in expiration, and a rarefaction of  $\frac{1}{36}$  to  $\frac{1}{25}$  atmosphere is sufficient to bring out the phenomena in all their sharpness.

Expiration into rarefied air, or rather the aspiratory suction which the apparatus exerts in expiration upon the air contained in the lungs, will by free removal of this air reduce the intrathoracic pressure which otherwise presses upon heart and vessels during expiration in proportion to the force employed, and materially influence the mechanical conditions of the circulation. The suction power of the apparatus which acts upon the pulmonary surface during expiration will, more or less, impede the contraction of the cardiac muscle, facilitate the diastole, and fill the lungs with blood. The efflux of blood from the veins to the right auricle is thus materially promoted; more blood flows to the left ventricle and passes into the aortic system with every systole, with corresponding increase of pressure therein. The arteries are thus more abundantly filled with blood than in inspiration of rarefied air; they appear more or less tense, while the veins, as can be seen in the jugulars, whose blood is aspired by the negative pressure of the air in the lungs, instead of standing out, as in ordinary expiration, are compressed by the higher atmosphere pressure and collapse. In consequence of the pressure acting upon them they will also contain less blood, and the greatest amount of blood will be found in the lungs and in the arterial system. By too great rarefaction of the air the pulmonary hyperæmia may become so serious as to lead to vascular rupture and hæmorrhage.

Among direct investigations of the changes produced in the

circulatory organs by expiration into rarefied air we must first mention the kymographic experiments of Drosdoff and Botschetschkaroff. These observations, like the results of their kymographic investigations regarding the inspiration of compressed air, are in contradiction to the reports of Waldenburg, and do not admit the influence upon the heart and the vessels which he ascribes to the diminution of intra-thoracic pressure during expiration.

In Drosdoff and Botschetschkaroff's experiments the animal was made, after inspiring ordinary air, to expire into rarefied air under a negative pressure of  $\frac{1}{40}$  atmosphere, while the other conditions remained the same as in the former experiments. The most remarkable thing here observed, in contrast to the prolonged expirations observed in human beings, was that in expiration into rarefied air the breathing became less deep, the expiration less free, and the whole respiratory act considerably shortened. At the same time the blood pressure in the aortic system increased, contrary to Waldenburg's theoretical deductions, both before and after the division of both vagi. The heart beat became irregular, somewhat slow, and the systolic impulse stronger than normal. No accumulation of blood in the veins or increase of blood pressure within them was observed during expiration into rarefied air in the experiments of Drosdoff and Botschetschkaroff.

As in the experiments upon the inhalation of compressed air, so also in expiration into rarefied air, the results which Zuntz obtained with regard to blood pressure are in agreement with those drawn by Drosdoff and Botschetschkaroff. The curve B in fig. 64 gives the respiratory curve, B' the blood pressure in expiration into air rarefied by  $-16$  mm. Hg =  $\frac{1}{8}$  atmosphere. The curves B and B' were taken from the same animal a short time after the curves A and A' (fig. 45).

Zuntz found, like the Russian investigators, that by this method of breathing the blood pressure undergoes a certain rise, because it promotes the aspiration of blood into the thorax. But the influence of expiration into rarefied air in raising the blood pressure is, as Zuntz found, not only in this experiment but generally, much slighter than the influence of compressed air in reducing the pressure. Whereas in those earlier experi-

ments, the latter effect always increased with increased condensation of the air, the experiments connected with our present subject showed the maximum value even with slight rarefaction of air. Zuntz believe the cause of this difference to be as follows: that as soon as, owing to increased aspiration of the thorax, the pressure in the cervical or abdominal veins sinks below that of the atmosphere, the walls of the veins are compressed by the latter, and thus the further transmission of the suction action is prevented. The ventilation of the lungs is promoted by expiration into rarefied air, and, as the organs are thus sufficiently provided with oxygen, in this case also there is generally diminished excitement of the vasomotor centre, and this is also opposed to a great rise of pressure.

The relation of blood pressure to the respiratory phases is clearly represented in fig. 64. A depression of the blood-pressure curve runs parallel with the expiratory diminution of pressure, and this fluctuation of blood pressure is of the same extent in respiration of rarefied as of compressed air, because it is independent of the conveyance of blood to the thorax.

As regards the contradictions that exist between the results of the published experiments on animals and the phenomena observed in the human subject, Zuntz accounts for the contradictory statements by the fact that, in addition to the mechanical conditions which alone have been hitherto regarded by authors, the innervation of the bloodvessels plays a considerable part in the origination of the phenomena in dispute. If the influence of vascular innervation, so strikingly evident in his experiments, is taken into account, Zuntz maintains that all phenomena hitherto observed, and also the contradictions between the reports of the different authors, are very easily understood.



FIG. 64.

As in the former experiments so also in this case, Waldenburg does not refer the results of the experiments on animals to the tension of the arterial tube and the fulness of the artery, but only to blood pressure, and he seeks to maintain his objections in opposition to the results of these experiments and the deductions from them. The blood pressure, he says, forms only one link in the series of factors which influence arterial tension, and he omitted to take that into account in his former considerations. Besides, the most perfect experiments on animals for testing this mode of respiration have nothing in common with human expirations, voluntarily prolonged, not short or spasmodic, the influence of which on the respiratory organs, as might be concluded *à priori*, would be entirely different.

On account of the importance of the influence upon the vascular system here under consideration, we will now repro-



FIG. 65.

duce more in detail the pulse changes which occur during expiration into rarefied air, as observed in the sphygmographic experiments.

In Riegel's and Frank's experiments expiration into rarefied air was preceded each time by a deep inspiration of ordinary atmospheric air. The rarefaction of air which they employed in their experiments was on the whole varied, but most frequently 30 to 40 lbs. were suspended to the cylinder. In the experiment in which the curve (fig. 65) was obtained 30 lbs. had been suspended to the pneumatic apparatus, which represent a suction action of  $\frac{1}{6}$  atmosphere negative pressure.

The five first pulsations represent the normal curves of the person under experiment, in perfect health and 18 years of age; the remaining portion of the curves occur during expiration. The tracings taken a short time after the beginning of expiration show as an essential characteristic a somewhat prolonged

line of descent, as well as a very strongly marked dicrotic wave and secondary wave of elasticity. Subsequently the pulse decreases considerably in volume; the dicrotic wave sinks lower, increases considerably in size, and for a time the pulse assumes even a hyperdicrotic character. The waves of elasticity, on the other hand, have quite disappeared. Towards the end of the curve the dicrotic waves again become smaller, while the height of the pulse waves again increases. There is a not inconsiderable increase of frequency during expiration into rarefied air. In the second curve (fig. 66), which was taken during an experiment in which the negative pressure was raised  $\frac{1}{30}$ , the most important changes regard the form of the curve, and especially the dicrotic wave, which sinks somewhat lower and becomes more distinct. The pulse wave decreases somewhat, while the frequency is only slightly increased.

If we now examine the changes in the pulse as shown in

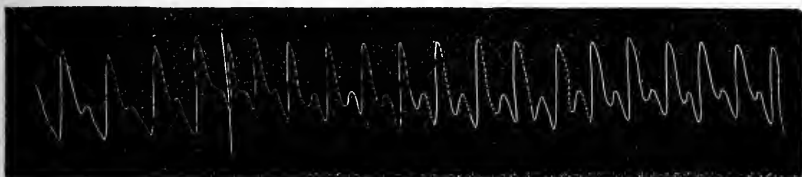

FIG. 66.

the sphygmographic tracings taken under the influence of expiration into rarefied air, they for the most part indicate diminished tension and diminished fulness of the arteries. This is shown in the first place by the smallness of the pulse, the deeper position and greater distinctness of the dicrotic wave, as well as by the disappearance of the waves of elasticity, and lastly by the increased frequency. We can best realise the difficulties and unforeseen disturbances to which these investigations are exposed from the fact that even in individual experiments which have been carried out in a perfectly faultless manner an almost negative result, or else only insignificant changes in the direction indicated above, have been observed. The pulse curves obtained by Sommerbrodt during expiration into rarefied air differ from those published by Riegel and Frank chiefly in this, that they show the influence of expiration on the circulatory organs from its commencement, and it there-

fore presents specific divergences from the others. In expiration into rarefied air the initial action is a forced expiration, which is only gradually aided by the suction action of the apparatus, which does not come into full play at the beginning but at the close of the expiration. For this reason the first mechanical effect of expiration upon the curves, during the tracing of which expiration begins as at *a* (fig. 67), must necessarily express itself in a rise of arterial pressure and increased tension in the arteries. This rise must be relatively more considerable than the initial depression in the inspiration of compressed air, as in the latter case the not inconsiderable negative pressure of the lungs on the heart already present is but moderately increased, whereas in the former the negative pressure is extraordinarily diminished.

The rarefaction of air in the apparatus during the experiment in question amounted to  $\frac{1}{50}$  atmosphere; the subject of



FIG. 67.

the experiment was the same person from whom the curves during the inspiration of compressed air were taken. In fig. 67 the curves from *a* to *b* show the increase of vascular tension and the increased fulness of the arteries at the beginning of expiration, and the oscillations are exceedingly well displayed. In *b* to *c*, on the other hand, a rapid fall of the blood pressure is evident, such as was also expressed in Riegel and Frank's curves.

It appears to Sommerbrodt not impossible that, taking these conditions into consideration, the contradictions between the observations on the human subject and Drosdoff's experiments on animals may yet find a solution, as the kymographic drawings of the latter undoubtedly include the oscillations of blood pressure just mentioned, in part very considerable and opposed to the main actions; still Sommerbrodt was not able to give any satisfactory explanation of these differences.

The following pulse tracings by Schreiber are more in accordance with the experiments on animals than the preceding ; he, like Sommerbrodt, found at the beginning of expiration a considerable increase of vascular tension and increased fullness of the arteries, but he failed to obtain with the commencement of the aspiratory suction of the rarefied air such a diminution of the blood pressure and of arterial tension as Sommerbrodt.

In the inspiratory pulsations in fig. 68 drawn to the left of the arrow the base line rises and the lines of descent show numerous waves of elasticity. After this the base line falls till the fourth expiratory up-stroke, while the six last pulsations stand again upon a higher base line. The lines of ascent of the pulsations belonging to the falling base line are increased as in Sommerbrodt's; the rest are of the same height as the introductory inspiratory line of ascent. The dicrotic wave is not distinctly developed in any of the pulsations, whereas



FIG. 68.

the lines of descent not only preserve to the end the former waves of elasticity, but towards the close of the expiration we can even discern the occurrence of new ones. Nevertheless in expiration into rarefied air the average blood pressure sinks in the first stage, while the individual pulsations are large and hard ; in the second stage the average arterial pressure rises, the artery is fuller, the pulse of inspiratory height and of still increasing tension.

As already observed and explained by Zuntz, expiration into rarefied air exerts no proportional influence over the vascular fullness and tension of the vascular walls to that which the inspiration of compressed air does in the opposite sense. So soon as, by increasing suction action of the thorax, the pressure in the cervical or abdominal veins sinks below that of the atmosphere, the venous walls become necessarily compressed

by the pressure of the atmosphere upon them, and thus the further transmission of aspiration is arrested ; therefore no considerable amount of blood is conveyed to the lungs.

Waldenburg brought to the support of his earlier deductions the results of his later investigations with the angiometer (*Pulsuhr*).

When the air in the cylinder of the apparatus was rarefied the cylinder could be filled in 7 to 8 expirations by the person under experiment. During these 7 to 8 expirations into rarefied air arterial tension was diminished by 15 grammes = 27.6 millimetres mercury. The arterial diameter was diminished by 0.20 millimetre, therefore the arterial fulness by  $\frac{2 \cdot 0 \cdot 20}{3 \cdot 14}$  = 9.66 per cent.

In these experiments Waldenburg was only able to observe, at the commencement, a few pulsations with enlarged wave (0.05 millimetre); later on diminished pulse waves of 0.03 to 0.02 millimetre only occurred. The diminution of arterial tension and of the arterial diameter generally lasted only a few minutes after the end of the experiment.

Finally Waldenburg tried to prove that the influence of the rarefaction of air during expiration on the heart and blood vessels continues during the subsequent inspiration. Since a portion of the residual air has been withdrawn from the lungs and the remaining air undergoes the same rarefaction as the air into which the expiration took place, therefore in the subsequent inspiration an abnormally small quantity of air is left in the lungs, and consequently an abnormally large space for the vital capacity plus a part of the residual space—to fill with fresh air. But as the bronchial air-passages are not distended beyond the normal they cannot convey in the same unit of time enough air to immediately supply the deficiency. The pulmonary air therefore remains during inspiration still in a state of abnormal rarefaction, and its effects upon the heart continue even during the inspiration. The action of negative pressure may be increased by a rapid and very deep inspiration, and so considerably that it becomes higher in degree during inspiration, therefore in the intervals between the expirations than during the expiration itself; on the other hand, gradually slow, though



deep inspirations weaken considerably the influence of expiration on the circulatory organs.

By these proceedings the influence of expiration into rarefied air upon the heart and the vessels can be regulated by making the patient inspire after the expiration either rapidly and deeply or slowly and deeply, according as it is desired to augment or diminish the action upon the circulatory organs. This is especially important in the case of many emphysematous subjects, when a retraction of the lung tissue is desirable but no special action on the heart and the vessels is desired.

We are as yet in possession of little material in the way of observations regarding a possible secondary effect upon the circulating organs; Schreiber's investigations on this point, as also with regard to the preceding changes of air pressure, lead to a negative conclusion.

### III. DYNAMIC ACTION.

Besides these purely mechanical effects on the heart and the vessels, Biedert has endeavoured to prove from his observations of inflammatory processes on the respiratory mucous membrane that there is also an actual dynamic influence both in inspiration of compressed air and expiration into rarefied air.

The apparatus no doubt exercises a very irritating influence upon the mucous membrane of the air passages and upon the lungs by friction of the air energetically streaming in and out, as well as by the repeated changes in the pressure and fulness of the vessels. The effect of the former on the mucous membranes can be best observed in a recent catarrh, in which the current of air driving by them is felt quite like an irritative agent. A similar irritation must naturally arise when the capillaries, emptied by the inspiration of compressed air, become again tensely filled during the subsequent deep expirations into the open air, and conversely after an increased influx of blood in consequence of expiration into highly rarefied air become again compressed and emptied during the succeeding ordinary respiration. These alterations in the fulness of the vessels were observed by Sommerbrodt even at the beginning and end of one and the same respiratory movement with the pneumatic apparatus, according as the activity of the inspiratory muscles

or the pressure of the apparatus prevailed. Further, Riegel has recently observed the pulsus paradoxus of Griesinger, Kussmaul, Traube, &c.—i.e. an observable alteration in the fullness of the vessels in inspiration and expiration in the simple deep respirations of subnormal and youthful persons, while Sommerbrodt believes it to be general. A still more important influence upon the circulation will naturally be exercised during the application of the apparatus by the deepened respirations of the more strongly dilated or contracted lungs. Biedert himself has communicated various observations on patients in proof of the general irritative action set up.

In cases of aggravated acute catarrh even hæmoptysis was excited; in that of another patient with asthmatic catarrh an attack of asthma lasting 24 hours followed inspirations of compressed air and expirations into rarefied air; lastly, in a third case, one of chronic bronchitis, in which increased troubles set in for two days in consequence of the patient's having exposed himself to wind and dust, inhalations of compressed air were employed with decidedly unfavourable results. These experiences are of importance in the positive as well as the negative sense.

The irritation induced by the change of intra-pulmonary pressure has in suitable cases an alterative effect on the whole of the bronchial mucous membrane, excites the relaxed capillaries to contraction in chronic bronchial catarrhs, alters and stimulates the circulation of the blood, and removes stasis. Such are the results which have been observed in chronic inflammatory processes by Biedert, Störk, and myself from expiration into rarefied air alone or from the alternate application of condensed and rarefied air, such as the improvement and cure of chronic bronchitis, admitting of no other interpretation. But, on the other hand, these variations of pressure, just as in the application of astringents, are counter-indicated in cases in which the acme of acute inflammation is not yet passed and the mechanical influence of condensed or rarefied air would act as a new and even more violent excitant of inflammation; also in doubtful cases we must employ feeble pressure and short sittings at the commencement. According to all the experiences hitherto laid before

us, the greatest caution is required with rarefied air, which produces the greatest amount of irritation, and by dilatation of the pulmonary blood channels exerts most influence upon inflammatory symptoms.

If, however, we observe the warning afforded by Biedert's cases, it becomes possible, as he himself admits, by beginning quietly and cautiously, by giving and withholding judiciously, to treat cases which, without these precautions, would be inaccessible to pneumatic treatment, and which perhaps for this reason have hitherto been so.

#### IV. CHEMICO-PHYSIOLOGICAL ACTION.

The therapeutic value of change of blood pressure upon the respiratory organs has been supposed to be due chiefly to its mechanical effect, and the alteration in the exchange of gases, i.e. in the absorption of oxygen and excretion of carbonic acid, has been taken into account, only so far that by the mechanical influences of pressure, portions of the lungs which were previously lost to the respiratory process are again made available, and thus a larger, that is to say the normal, quantity of oxygen is again received with every respiration. A stimulation of the oxidising processes in the body and the therapeutic consequences which follow from it have not been taken into consideration in weighing the mechanical effects of pressure, such as result from the employment of the transportable pneumatic apparatus.

If Speck's estimates of the absorption of oxygen and excretion of carbonic acid under the influence of changes of air pressure had been less critically viewed, it might have appeared as if an increased oxidation in the body had been combined with the result of these higher values, and, supported by these experiments, the idea might have been entertained of utilising certain changes in air pressure for altering the oxidising processes in the system and thus obtaining definite therapeutic results. But this theory was found to be in direct contradiction to actual facts, as the increased absorption of oxygen and excretion of carbonic acid in these experiments, as Speck specially insists, are not to be regarded as

the expression of a more rapid oxidation, but as the result of the simply physical process of the diffusion of gases.

If, in reference to this, we first consider the excretion of carbonic acid, it is, as can be directly ascertained by inspiration of air charged with carbonic acid entirely dependent on the amount of carbonic acid contained in the inspired air. The richer the air is in carbonic acid the less can be exhaled into it from the blood and from the pulmonary air. When the respiratory air contained 7 per cent. of carbonic acid the blood gave off no carbonic acid whatever to the air, and all the carbonic acid generated was retained in the system (Speck). When the inspiratory air was charged with yet a higher amount of carbonic acid, a portion of this was actually taken into the blood, as much as 1.041 gramme in the minute when the air contained as much as 1.5 per cent., so that the percentage of carbonic acid in the expired air became less than that in the inspired air. But thus also the dependence of the expiration of carbonic acid on the amount of carbonic acid contained in the inspiratory air is fully proved according to the laws of the diffusion of gases. Therefore when there is a more abundant supply of air the amount of carbonic acid contained in the pulmonary air standing immediately over the blood must be diminished and in the converse case increased, and thus in the first instance the diffusion of carbonic acid from the blood will be facilitated, in the second it will be impeded. In general the absolute excretion of carbonic acid increases with the increasing quantity of the inspired air, and the percentage of carbonic acid in the expired air diminishes.

Secondly, the absorption of oxygen is also subject to the laws of the diffusion of gases, and its absorption by the blood fluctuates according to the partial pressure of oxygen in the inspired air, as Speck holds, within far wider limits than has been hitherto supposed.

In his experiments the absorption of oxygen rose from 0.323 gramme in inspiratory air containing 9.16 per cent. of oxygen up to 0.786 with a percentage of 63.48. Whereas the absorption of oxygen rose on an average by 0.008 to 0.009 for every 1 per cent. of additional oxygen, it was found, when the increase was reckoned from 1 to 10 per cent., that the

absorption of oxygen increased in inverse proportion to the increased percentage of it in the inspiratory air. From 10 to 20 per cent. the increase of absorption of oxygen amounted to 0·013 gramme, from 20 to 30 per cent. pretty nearly the same, from 40 to 50 per cent. 0·007, and thenceforward as far as 63 per cent. only 0·003 gramme for each 1 per cent. increase of amount of oxygen in the inspired air. The fluctuations which may occur in individual experiments are simply to be ascribed to the fact that the absorption of oxygen is only partially dependent on the diffusion of gases in the blood.

In the calculation of the percentage of oxygen contained in the expired as compared with that of the inspired air, it appeared that the more oxygen there was absorbed the more oxygen in proportion the inspired air contained; the difference between the amount of oxygen in the inspired and expired air increased up to 42·73 per cent.; then the difference, instead of increasing, diminished slightly up to 63·48 per cent. This behaviour, apparently remarkable, is easily accounted for by the circumstance that the blood must eventually reach a state of saturation towards every amount of oxygen contained in the air.

This condition of saturation also accounts for the fact that the absolute absorption of oxygen contained in the inspiratory air turns out to be much slighter in the higher percentages than in the lower.

As regards the proportion of the expired carbonic acid to the inspired oxygen Speck's further experiments show that it is actually only a question of liberated oxygen, coming under the physical laws of the diffusion of gases. The excretion of carbonic acid, so far from undergoing an increase with the augmented absorption of oxygen, either remained the same or showed a decrease. Speck found the greatest amount of carbonic acid excreted with the lowest absorption of oxygen; with increasing absorption of oxygen the excretion of carbonic acid suffered a gradual reduction. This diminution was conditional upon the diminution of the quantity of inspired air and was wholly independent of the absorption of oxygen.

When the inspiratory air contains but little oxygen, according to the experiments reported, it is altogether insufficient

to form the expired carbonic acid, and when the quantity contained is greater, half of the absorbed oxygen is required for the oxidation of the hydrogen; in the former case then, the amount of oxygen absorbed is not enough for a quantity of expired carbonic acid, while in the latter more disappears than is again expired, as the carbonic acid generated requires exactly its own volume of oxygen for its formation.

In the action of altered air pressure on the respiratory process, due to the employment of the transportable pneumatic apparatus, the absorption of oxygen and excretion of carbonic acid is dependent on the ordinary physical processes of the diffusion of gases, and must not be regarded as the result of a stimulated oxidation. What is effected by air highly charged with oxygen will be effected by compressed air in which the partial pressure of oxygen is increased in the measure of its condensation, and the same result follows an increased supply of air, for in this case deoxygenised air is removed in greater quantity than usual from the lungs, and the air coming into immediate action on the blood is more fully oxygenated. At the same time absorption of oxygen and excretion of carbonic acid are entirely independent of one another, even though they follow one and the same law. An increase of their quantity depends only on the pressure to which the respiratory air is subjected, and on the amount of increased ventilation of the lungs, but the amount of this increase is also very different under these circumstances, according to the diffusibility of the two gases.

#### V. COMBINATIONS OF THE DIFFERENT MODES OF APPLICATION.

If, besides the mode of application of the four kinds of alterations of air pressure already spoken of, in which only one phase of respiration, either inspiration or expiration, is acted upon at a time, it should be desired to subject both acts at the same time to altered conditions of air pressure, the raising and lowering, by the pressure of one atmosphere, the respiratory air pressing upon the lungs may again be combined in a four-fold manner, as follows:—

1. Inspiration of compressed and expiration into compressed air.

2. Inspiration of compressed and expiration into rarefied air.

3. Inspiration of rarefied and expiration into compressed air.

4. Inspiration of rarefied and expiration into rarefied air.

Of these four possible combinations only one, inspiration of compressed and expiration into rarefied air, has been employed therapeutically, as the others are not very well calculated for curative purposes, and can be replaced by partial changes of pressure, also because a greater amount of strength and dexterity is required to carry them out rightly than can be expected from the majority of patients. Speck is the only person who has subjected to a further trial the inspiration of rarefied and expiration into condensed air, as also the inspiration of compressed and expiration into compressed air, in his scientific investigations upon the influence of altered air pressure on the respiratory process.

The results which he obtained are, however, of no interest for the accurate estimation of the influence of altered air pressure on the respiration in connection with pneumatic treatment, and therefore have no place here.

(a) *The inspiration of rarefied and expiration into condensed air* with an average difference of pressure of 22·4 centimetres raised the respiratory air to 1·44, the absorption of oxygen to 1·08, and the excretion of carbonic acid to 1·26 of the normal amount.

The respiratory air, however, again diminished on reaching a certain degree of difference of pressure, whereas the absorption of oxygen somewhat increased; not so the excretion of carbonic acid, which remained fixed. The ratio of inspired to expired air was raised as in forced respiration, yet it appeared as if with increased pressure it again approached nearly to the normal; the same phenomenon was exhibited in the ratio of the inspired oxygen to the oxygen of the carbonic acid. The depth of the respirations increased very evidently with the increase of the respiratory impediment, and their frequency, which had increased under slight pressure, diminished.

As soon as the respiratory impediment was removed, the respiration still remained evidently forced, the respired quantity

of air still remained considerably increased, and most so apparently after the strongest respiratory impediment had been encountered. The ratio of inspiration to expiration did not stand very high; the absorption of oxygen was still somewhat higher, and the discharge of carbonic acid had also remained somewhat increased. The ratio of the inspired oxygen to that carried off in the carbonic acid still indicated forced respiration, but the tendency towards return to normal respiration and to an equalisation by sparing respiration became observable. The depth of the respirations very soon diminished, and declined to the normal average and lower; it was at the same time influenced by the greatness of the impediment it had to overcome, and remained most marked where the hindrance had been greatest. The respiratory frequency was considerably increased, in inverse order to the depth.

(b) *The inspiration of compressed and expiration into compressed air*, with slight excess pressure in expiration, induced a very considerable increase of respiratory air, a moderate increase in the absorption of oxygen, and a somewhat greater excretion of carbonic acid, so that the ratios to the normal amount were 1 : 1.47, 1.08, and 1.23. The expired air at the same time attained a slight excess over the inspired, and almost all the oxygen inspired was carried away in the carbonic acid. Depth and frequency of the respirations were moderately increased.

Immediately after these respiratory experiments the respiratory air still remained somewhat increased, while the absorption of oxygen and excretion of carbonic acid returned to its normal limits. The ratio of inspiration to expiration still continued somewhat high. On the other hand the excretion of carbonic acid receded in comparison to the absorption of oxygen; their ratio was reversed and a balance was established with regard to the previous respiration. The depth of the respirations had decreased considerably, while their number increased perceptibly.

While it might have been already deduced from the former experiments of Speck that every change of air pressure, whether it affected inspiration or expiration, increases the respiratory activity, and that this occurs most markedly and evidently



when respiration is facilitated by changes of pressure, these experiments revealed the striking fact that even pressure conditions which acted as impediments to inspiration and expiration yet produced an increased activity and energy whenever the impediment could easily be overcome by muscular activity. If the impediment exceeded this, then respiration was perceptibly embarrassed. In inspiration of rarefied and expiration into condensed air, when the impediment was greatest, with a difference of pressure between 20·6 and 25·1 centimetres, the respired air diminished, and the ratio of the inspired oxygen to the expired carbonic acid again approached the normal, so that we may assume that with continued pressure these ratios would be reversed.

The second combination of

*Inspiration of compressed and expiration into rarefied air* was at first employed in the following manner: The patient was for some time caused to inspire compressed air and expire into ordinary air; after that he was allowed to expire for some time into rarefied air in the manner which the several apparatus admit of. It is clear that with this method the mechanical action of the double changes of air pressure upon respiration and circulation was not fully developed, as also the partial action of the excess of pressure applied could not be paralysed by an immediately succeeding opposite pressure, nor could one mechanical effect be supported by the other.

### 1. *Effect on the Respiration.*

When condensed air is continuously forced into the lungs during inspiration and sucked out again into rarefied air in the subsequent expiration, the direct effect of this mechanical process is to increase the general efficiency of the respiratory apparatus. By means of the compression-pressure employed, the inspiratory movement, as in inspiration of compressed air generally, receives an addition of strength which easily overcomes the inspiratory resistances, and the thorax and the lungs become more dilated than is possible in the deepest inspiration. Similarly also in pathological states the bronchi, swollen and narrowed or obstructed with mucus, become permeable; the collapsed alveoli, containing stagnant air, are again distended,

and filled with fresh air of higher tension. A larger amount of air is conveyed to the lung than is possible in the greatest normal inspiration. If expiration into rarefied air now follows, then by its aspiratory suction not only the respiratory air, but also a portion of the residual or reserve air will be withdrawn, in proportion to the force employed; no higher pressure is obtained than by the partial influence of compressed air in the lungs; the lungs do not remain distended, but immediately after the inspiration of condensed air a suction comes into play which even, according to circumstances, overcomes the pressure itself, and again supports the retractile effort of the lungs, so that they can contract energetically and completely, as in ordinary respiration. So, then, positive and negative tensions of air do not counteract one another, but rather act in one and the same direction. Since the inspiration of compressed air causes the lungs to become more distended with air and dilates the stenosed air passages, it becomes possible in the course of the sitting, for the aspiratory suction of the rarefied air to act generally, as well as on separate portions of lung, which may be emphysematous or which may lie beyond the stenosed passages. This alternate expansion and retraction of the lung tissue also greatly stimulates and increases its elasticity; on the other hand the expiratory muscles are aided in their task by expiration into rarefied air in the same way as the inspiratory muscles by the inspiration of compressed air. Thus by the alternate action of positive and negative pressure both phases of respiration are more completely accomplished, inspiration and expiration alike, than by the partial action of either separately. The lungs not only receive with each inspiration a larger quantity of fresh, more richly oxygenised air of higher density, which always mixes with the pulmonary air, but also in the subsequent expiration a quantity of air exceeding the inspired volume is again expired, and at the same time a part of the stagnating residual air charged with carbonic acid is removed. Hence it naturally follows that the pulmonary ventilation proceeds more rapidly and the exchange of gases must experience a very considerable stimulation.

Speck found that the respiratory air was increased in higher proportion in alternate inspiration of compressed and expiration

into rarefied air ; in the greatest difference of pressure employed by him, 17·6, the ratio was 1 : 2·30. The absorption of oxygen and the excretion of carbonic acid also increased perceptibly, in the ratio of 1 : 1·20 and 1 : 1·71. This increase rose with the difference of pressure, and the rise is more considerable than with the other methods we have dealt with.

Speck also found a considerable increase in the ratio of inspired to expired air ; more air had been expired than inspired ; the excreted carbonic acid contained considerably more oxygen than was inspired. The increase in the depth of the respirations occurred in the ratio of 1 : 1·53, and in their frequency in the ratio of 1 : 1·50. A short time after the experiment the respiratory air was still somewhat increased, and still exhibited in the high ratio which the inspired air bore to the expired the character of forced respiration. This, however, only applied to the quantity of air respired. Absorption of oxygen and excretion of carbonic acid soon became again normal, and showed a tendency to diminution, which became clearly marked when the respiration was examined immediately after the cessation of the action of the altered air pressure. The tendency to a diminution and an equalisation of the whole respiratory process also showed itself in the high figure of the oxygen retained in the body. The depth of the respirations at once diminished and sank not inconsiderably below the normal, while the frequency remained heightened.

An anti-dyspnoëic effect must immediately follow the application of the influence which this alternate mode of respiration, the simultaneous changes of pressure during inspiration and expiration, exercises upon the breathing, without regard to the question whether inspiration or expiration or both are hindered.

Lastly, under a long-continued use of the treatment under medical guidance, in lungs with atelectatic conditions due to compression and infiltration, with chronic changes and thickenings of the bronchial mucous membrane, as also in emphysematous inflation and consequent diminution of the vital capacity, there is no doubt that a permanent increase of the vital capacity and of inspiratory and expiratory force will be obtained and clearly proved by means of the spirometer and pneumotometer.

The results readily deducible from the theoretic consideration of the mechanical influence of alternate condensation and rarefaction of the air on the lungs have already found general confirmation in practice, and the desired effects have been more rapidly and completely obtained than by the application of a partially altered pressure of air, or by intermittent inspirations of compressed and expirations into rarefied air, or by repeated inspirations of compressed air, in which pressure and suction do not work together in the same way and support one another.

## 2. *Action on the Heart and the Circulation.*

The application of intra-thoracic pressure increasing and diminishing in immediate sequence will exercise its influence not only on the mechanism of respiration but also on the heart and the circulation.

If the gradually increased pressure in the lungs during the inspiration of condensed air raises cardiac force in systole and facilitates the action of the heart, on the other hand the immediately succeeding diminution of the pressure during the subsequent expiration into rarefied air impedes the contraction of the cardiac muscle and lowers its efficiency. Waldenburg at first expressed a fear that, by the continuous action of two extreme pressures which act upon the heart in this form of respiration, we might burden the heart with an abnormal labour, or at least induce a considerable effort, and exert an influence not without danger to it and the circulatory conditions generally. Waldenburg's fears have not, however, been confirmed in this direction by the result of his experiments, and he has himself been led to retract them, while they were never entertained in any other quarter. On the other hand, positive and negative pressure in relation to the heart and its activity stand in opposition to one another and cancel one another, so that, although they do not exert any injurious influence upon the heart, no permanent therapeutic effect can be obtained by their means.

The continuous increasing and diminishing pressure in the lungs induces similar antagonistic effects in rapid sequence in the conditions of the blood current and the fulness of the vessels. Whereas during inspiration the blood of the lesser

circulation becomes more and more dammed up by the in-streaming of condensed air and eventually fills to excess the systemic veins, the aspiratory suction of the immediately succeeding expiration into rarefied air draws back the blood again to the pulmonary surface, facilitates the outflow of blood from the great venous trunks, supplies the pulmonary circulation more abundantly with blood, and proportionally increases the quantity of blood in the arteries of the systemic circulation. In this way there occurs a more rapid filling and emptying of the vessels, excluding partial hyperæmia: the flow of lymph in the tissues is generally accelerated, and tissue change and tissue nutrition are promoted. It is owing to this alternation of intrapulmonary pressure that no continuous influence can be obtained over the circulation by alternate inspiration, as by the simple inspiration of compressed air or expiration into rarefied air, where the like effect of pressure does not extend over the respiratory phase uninfluenced by the apparatus. The employment of the alternating methods, therefore, completely excludes the partial influence of positive or negative pressure on the heart and the vessels in the direction above mentioned. On the other hand the dynamic influence of inspiration of compressed and expiration into rarefied air, first brought forward by Biedert, may be developed more rapidly and sharply in suitable cases and necessitate greater precision in the indications. At any rate the treatment will not produce any actually injurious effect, even if cases running a subacute course are submitted to it, and any irritative effect of the changes of pressure, at once observable, should immediately lead to a modification of the method or a transition to emollient, soothing remedies and inhalations.

Lastly, as regards hæmorrhages, which might be induced by the constantly alternating changes in pressure and in the fullness of the pulmonary vessels, there is no greater danger here than in the use of the intermittent method or expiration into rarefied air, and in cases in which pulmonary hæmorrhages have already occurred or are to be feared the lungs should not be submitted to the suction action of diminished pressure.

It will be seen from these experiments and deductions that the field for the employment of the alternating method is

tolerably wide, and extends from the prophylactic treatment of feeble, phthisically predisposed persons with paralytic (*paralytischem*) thorax and undeveloped lungs, especially the upper lobes, and in the imperfect hæmatosis of anæmic and chlorotic conditions, chronic bronchial catarrhs, with copious mucous secretion, to aid and facilitate expectoration mechanically, up to compression and atelectasis of the pulmonary tissue after pleuritic exudations, bronchiectatic caverns, scrofulous pneumonias, bronchial asthma at the moment of the attack, and lastly certain cardiac affections which lead to disturbances of the pulmonary circulation and interfere with the chemical processes of respiration (according to Cube, Hänisch, Geigel, and personal observations).

The technical arrangement for the alternating method is simple on the whole: two apparatus are required, so combined with one another that the respiratory tubes communicate with one common valve, which, when turned, enables now the one apparatus with condensed air, now the other apparatus with rarefied air to be used. Most of the apparatus which are now in use admit of this combination, as those of Waldenburg, Schnitzler, Cube, Geigel, Finkler, and others, and may be used for the simple and combined method. If one apparatus is used regularly for inspiration, the other for expiration, even though they have been used frequently by different patients successively, cleanliness and exemption from infection are to a certain extent secured. Weil and Schnitzler have also constructed a double apparatus on Cube's principle, which, as already mentioned, have proved serviceable both for the simple and the combined method.

The intermittent methods can of course be carried out with all the apparatus.

### MODIFICATIONS OF THE METHOD.

In addition to the application of compressed and rarefied air to each respiratory phase or to both together, we may also alter the respiratory air itself, which is inspired under a strong pressure, not only in its physical constitution but in its chemical combination, and so endeavour to obtain, according

to the indications, other physical or chemical effects together with the mechanical effect. We propose, therefore, to consider the following modifications, derived partly from theory, partly from practice, of the simple pneumatic method with exclusively mechanical action.

1. *Alteration of the Physical Condition of Condensed Inspiratory Air.*

With regard to the physical behaviour of compressed air when brought into contact with the respiratory organs, the only alteration hitherto found necessary is that of raising its temperature.

Ranke attempted to modify the irritating effect of cold inspiratory air streaming in under increased pressure by warming it when it seemed necessary by previously filling his apparatus with warm water. More recently Tobold, and Hauke too, in his improved apparatus, have devised special arrangements for raising the temperature of the air as it flows out. Hauke recently recommended insufflations of air heated to about 45° C. in pharyngeal diphtheria, as I had myself done, and, according to Dr. Becker's reports, obtained favourable results. A reactive suppuration and the solution of the false membranes are promoted by the action of air raised to a higher temperature in the same way as by the influence of hot-water vapours. Hauke effected this change of temperature by connecting with his apparatus a Wulff's flask containing hot water. Waldenburg also connected the respiratory tube of his apparatus with a Wulff's flask, and filled it one-third with water of the temperature of 50° to 60° C. Again, a flask filled with water can be heated by a spirit lamp during the whole period of the inspirations and kept at an even temperature.

Waldenburg also called attention to the fact that the insertion of a Wulff's flask as well as direct heating lowers the density of the air, which becomes dilated. He balances this loss of pressure force by increasing the weights which effect the compression by an excess pressure of about 6 pounds.

## 2. *Alteration of the Chemical Constituents of Condensed Inspiratory Air.*

Atmospheric air, composed of a mixture of oxygen and nitrogen, can also be changed in its chemical constituents, in order that it may exercise, in addition to the mechanical, also a chemico-pharmacological influence upon the mucous membranes and the pulmonary surface, and also upon the exchange of gases and the respiratory process. These changes may be brought about in two ways—first, by increasing one or the other of the two gases constituting atmospheric air, and secondly, by mixing other gases or vapours with the air itself and causing them to be inhaled by means of the pneumatic apparatus under increased pressure.

### *(a) Increase of the several Gaseous Constituents of Atmospheric Air.*

As repeated attempts had been made at a former period to employ the inhalation of oxygen gas therapeutically, so the amount of oxygen contained in the air compressed in the pneumatic apparatus has been increased according to the same indications, in order to produce a series of specific effects under the simultaneous influence of increased pressure. We are not, however, in possession as yet of sufficiently convincing evidence to be able to decide whether or to what extent under such circumstances an influence can be gained over the processes of combustion and change of tissue, as well as over nutrition and sanguification, by increased supply of oxygen, although the mixture of oxygen with the inspiratory air has been repeatedly recommended in various quarters (Schnitzler). (Cf. *supra*, Inhalations of Oxygen.)

But even the inhalation of an increased quantity of nitrogen in pulmonary phthisis, to which recently many favourable results have been ascribed, has been repeatedly proposed and carried out in connection with the inhalation of compressed air. An accurate judgment of the results hitherto obtained and of the mode of action must be reserved for further investigations. (V. *supra*, Inhalation of Nitrogen.)



(b) *Combination of Volatile Medicinal Substances with Compressed Air.*

It was quite natural that even in the first attempts to employ the direct influence of compressed air on the respiratory organs the idea should suggest itself of combining with it medicated substances which volatilise at a corresponding temperature, and this idea has been very frequently carried into effect from the time that Hauke constructed the first transportable apparatus down to recent times.

Hauke began by simply adding vapours of marsh mallow tea in irritative cough, then turpentine, tar, decoctions of oak and pine bark, decoctions of fir cones, in copious mucous secretion, to the water of his apparatus; later on he constructed and described a separate receptacle for this purpose. V. Cube uses the vapours of fir oil to act upon the respiratory mucous membrane in combination with compressed air in chronic bronchial catarrh and in diffused bronchiectasis with offensive expectoration. Domansky uses oil of turpentine and carbolic acid in 1 per cent. solution with excess pressure of  $\frac{1}{120}$  to  $\frac{1}{60}$  atmosphere in phthisis with tormenting cough and mucopurulent expectoration, without having observed any symptoms of irritation. The cough and the expectoration diminished, and the lung capacity increased in the case of one phthisical subject from 2,850 to 3,100 cubic centimetres, in another from 2,100 to 3,200 cubic centimetres. Another combination of inspirations of condensed air or expirations into rarefied air with simultaneous or preceding inhalations of sal ammoniac in acute or chronic bronchitis, as well as in emphysema with bronchitis, was devised by Cron, who causes the more or less compressed air to pass through one or two combined Wulff's flasks filled with hot aqueous solution of sal ammoniac before it reaches the respiratory mucous membrane. As sal ammoniac only sublimates with dry heat, it is only the warm aqueous vapours which are here inhaled together with particles of sal ammoniac mechanically carried over by the compressed air (v. Sal Ammoniac, 'Chemical Part'). In pure bronchial asthma Biedert mixed four drops of amyl nitrite by means of his *Medicamentenköcher* with the compressed air inspired, and thereby obtained the desired results.

For generating the vapours and combining them with the compressed air either a Wulff's flask (v. Cube, Waldenburg, Domansky, Cron) or any other suitable contrivance (tin capsule, *Medicamentenköcher*), according to Hänisch and Biedert, may be used, being connected with the respiratory tube between cock and apparatus. The medicinal substances themselves are mixed with water or dropped on cotton wool in the receptacle, so that the air passing through under increased pressure collects the vapours as they are evolved and carries them into the terminal ramifications of the bronchi.

Another method has been introduced by Dr. Crabler and further employed by Hänisch. An orifice is made in the upper lid of the cylinder in Waldenburg's apparatus, which is closed airtight by a stopcock, and connected with a tin capsule containing the volatile substances, so that the apparatus is filled with air which passes through it. In this way the volatile medicaments mingle directly with the air flowing through the cylinder while it is in process of filling; then the cock is closed, and the now medicated air compressed and inspired.

It is needless to say that in the introduction of these different contrivances regard must be had to the resistances which on this account the compressed air meets with in its transit, and to the consequent loss of pressure, and a compensation of a few pounds must therefore be added, as when condensed air is warmed. A portion of the medicated vapours will also be lost in following Crabler-Hänisch's method through absorption by the water of the apparatus, and thus a stronger concentration will be necessary than in the case of simple inhalation; repeated experiments will soon enable us to find the right proportion for each case.

The number of medicinal substances which can exercise an influence upon the respiratory mucous membrane when inhaled in this manner together with compressed air is very small, and almost limited to a few ethereal oils and some other substances which volatilise at ordinary or slightly elevated temperatures. The indications for their employment are in general conditional upon those pathological changes which have been already mentioned in the first part of this work, and are not materially enlarged by combination with condensed air. It must not

be forgotten that condensed air itself acts as an irritant, which, when injudiciously used, aggravates acute and subacute inflammatory conditions of the mucous membrane, and may lead to unpleasant sequelæ. This will be still more the case when the compressed air is mixed with substances which in themselves exert an irritative and alterative influence on the respiratory mucous membrane, and it is quite possible that the air impregnated with these substances may act injuriously under circumstances where it would have been perfectly tolerated without that combination, or conversely the medicinal substances might have caused no irritation in the respiratory organs uncombined with the pressure action of the condensed air. Biedert has made some observations on this point which show that great caution is necessary in the employment of medicated compressed air.

In cases, therefore, where it is necessary to obtain, in addition to a mechanical influence upon the respiratory and circulatory organs, a chemical influence such as may be obtained from the volatile substances named, as also in cases which demand a more vigorous pharmacological action of other substances not so readily volatilised, it will be better to employ the earlier described methods of inhalatory treatment and to use these, together with mechanical treatment by means of the pneumatic apparatus.

## RANGE OF APPLICATION OF ALTERED AIR PRESSURE ACTING ON THE PULMONARY SURFACE ONLY.

### 1. *Indications.*

The general indications for the mechanical treatment of diseases of the respiratory, and in part also of the circulatory organs, may be logically deduced from the physiological influences of changes of air pressure on the inspiratory and expiratory current as set forth in the previous section.

1. Since, according to these investigations, *inspiration of compressed air* expands the lungs and the thorax, increases the lung capacity, and the inspiratory as well as generally the

expiratory pressure, aids the inspiratory force and promotes the ventilation of the lungs to a certain extent, while on the other hand it impedes the pulmonary circulation, forces the blood out of the pulmonary tissue and from the surface of the respiratory organs, and thus in part acts antiphlogistically, in part in a certain sense as a stimulant, it is capable at the same time of counteracting inspiratory and expiratory dyspnoea; therefore it will be found useful therapeutically in all cases in which the respiration is weak and superficial, in which the lungs cannot fully expand and are restricted in volume either naturally or pathologically, in which, therefore, the exchange of gases in the lungs is checked, and in which, finally, the vascularity in the respiratory mucous membranes and the lung itself is abnormally increased, therefore in the phthisical habit, in phthisis itself, in pleuritic exudations, pulmonary atelectasis, bronchitis, asthma, stenosis of the upper air passages and the trachea, asphyxia, &c.

2. And further, since a portion of the residual air is pumped out, and the intra-thoracic pressure reduced under physiological conditions by *expiration into rarefied air*, and the lung consequently retracted, expiratory pressure in the lungs and lung capacity are increased, the lung is freely ventilated, and, in contradistinction to the effect of inspiration of compressed air, the pulmonary blood vessels are widened; thus the vascularity of the lungs is increased and a specific stimulation exercised upon the tissue itself; therefore indications for the employment of expiration into rarefied air will exist in cases in which the lungs are dilated beyond their normal volume, the expiratory force enfeebled, and the air in the lungs stagnating, in which there is a diminished amount of blood in them and the exchange of gases no longer proceeds normally, in consequence of their deficient retractile force, therefore in bronchitis, emphysema, phthisis, &c.

3. As the mechanical influence on the affected organs by means of pneumatic apparatus is not always dependent on the particular disease which exists, but more particularly on the symptoms which may induce conditions only remediable by mechanical measures, therefore in individual cases when attended with simultaneous development of several such con-

ditions in the lungs, *inspiration of compressed air* must be employed as well as *expiration into rarefied air*.

## 2. Counterindications.

The increase or decrease of intrapulmonary pressure by means of the pneumatic apparatus is counterindicated in a series of pathological conditions in which a definite change of pressure acting upon the lungs and the intrathoracic vascular system either gives rise to mechanical lesions or to irritation in these or other organs influenced by this pressure.

(a) *Compressed air* is counterindicated in cases in which it is dangerous to the lung itself to increase the pressure on its surface, as well as those in which congestions or hæmorrhage or a disposition thereto exist in some organ external to the thorax. Under this head would also come atheromatous degeneration of the vascular walls, a tendency to cerebral hæmorrhages, the apoplectic habit, and especially a tendency more or less pronounced to hæmorrhages in the region of the systemic circulation, gastric and renal hæmorrhages, profuse hæmorrhoidal hæmorrhages, &c. Also in engorgements of the systemic veins, in affections of the respiratory and circulatory organs associated therewith and leading to secondary renal affections, inhalations of compressed air, which, as we have shown, directly impede the outflow of the blood from the great venous trunks, are always to be avoided.

(b) The employment of *rarefied air* is counterindicated in those pathological conditions in which the flow of blood to the lungs is already increased and there is danger of vascular rupture and hæmorrhage, also in inflammatory states and in cases in which the blood pressure is already much reduced, consequently in general debility and especially in weakness of the cardiac muscle.

Acute inflammations of the respiratory mucous membranes, and especially of the lungs, as also advanced bronchiectasis, counterindicate all mechanical treatment.

## SPECIAL THERAPEUTICS OF ALTERED AIR PRESSURE APPLIED BY MEANS OF APPARATUS TO THE PULMONARY SURFACE.

### (A) IN DISEASES OF THE RESPIRATORY ORGANS.

#### 1. *Respiratory Insufficiency.*

The first effect produced upon the lungs by the mechanical action of the apparatus employed is, that changes of the contained air are effected by pumping and sucking it out in larger quantities than is possible in ordinary respiration. As this process cannot be carried out without a greater call on the respiratory force than usual, and the necessary excess force is supplied by the apparatus, the first indication for the employment of the pneumatic method will be afforded by those conditions in which the exchange of gases in the lungs is defective, whether this insufficiency be brought about—

1. By loss of power in the respiratory forces without any impediment to the ingress or egress of air;

2. In cases in which conditions are present interfering with the play of these forces, or—

3. When the respiratory force is normal or even increased, but some obstruction exists in the air passages.

The indication for the use of pneumatic treatment will therefore occur—

1. In all circumstances in which a general weakness of the respiratory organs exists without any distinctly recognisable disease, and secondly in persons with a long, narrow, flat, so-called 'paralytic' thorax, the strengthening and transformation of which, as we shall see farther on, forms a chief part of pneumatic treatment.

Also in the case of persons who, as a result of their mode of life, rarely breathe deeply and vigorously, and so interfere with the natural expansion of the lungs in various ways, especially in young persons who, by faulty deportment and distorting attitudes, either at home, at school, or in the workshop, run the risk of establishing a more or less permanent deformity.

Lastly, in all cases in which, as a result of imperfect nutri-

tion or a diseased state of the blood, the respiration is short and superficial, when physical examination reveals no change in the lung, as is frequently the case with anæmic or chlorotic persons.

In all these cases there is no actual disease present, but only the lowering of a physiological function in a greater or less degree, where it is not impossible that this embarrassment of the respiratory process by incomplete activity of the respiratory muscles, by the defective expansion of the lungs, by insufficient pulmonary ventilation and diminished supply of oxygen, may eventually prevent favourable conditions for the development of general and localised pathological processes and a general lowering of nutrition and strength. By the introduction and removal of larger quantities of air under increased pressure, the abnormally depressed respiratory function, with all its consequent effects upon the play of the respiratory muscles, the lung capacity, the exchange of gases and the nutrition, will not only be restored to the normal condition, but even increased, and this increased efficiency may at once be proved by figures which show an increase of the circumference of the thorax and of the vital capacity. Again, in all illnesses running a chronic course, for the most part without fever, the pneumatic treatment will be advantageous by promoting tissue change in the lungs, by supplying a sufficient quantity of fresh respiratory air, and by affording free excretion of the used-up air highly charged with carbonic acid, even though other indications arising out of the actual illness itself call for this treatment. The further consideration of these relations and the more precise definition of the indications they present, will be treated of under the several pulmonary affections concerned.

2. As regards the circumstances which prevent the full play of the forces allotted to respiration, the mechanical part of the respiratory process may be disturbed by pathological conditions in a greater or less degree, from short, incomplete, superficial respiration to complete cessation of all respiratory movement and entire interruption of the exchange of gases. At the same time the air passages are perfectly free, there is no impediment to the ingress or egress of air, but the muscular forces here concerned are more or less restricted either through reflex

disturbances proceeding from one quarter or another, or else, in consequence of pathological changes in the medulla oblongata and the respiratory centre, their function is either imperfectly performed or even altogether abolished. The cases already on record show what favourable results may be obtained in these instances by the mechanical employment of artificial respiration by means of the pneumatic apparatus.

(a) Among cases of the first kind diseases of the pleura must especially be reckoned; in dry pleurisy respiration becomes so painful from adhesion of the pleural surfaces (Schnitzler) that the patients breathe quite superficially, and the exchange of gases in the lungs, generally already impeded by diminished lung-capacity from chronic tissue infiltration, emphysema, or cirrhotic processes, is only incompletely and insufficiently effected. Schnitzler has frequently observed this *pleuritis adhesiva chronica* as the first symptom of phthisis, and according to his experience it not infrequently furnishes an important etiological influence in the development of pulmonary consumption.

(b) *Asphyxia*, the highest degree of arrested respiration, from incomplete to absolute, induced by the inhalation of irrespirable gases or volatile medicines (carbonic acid, chloroform, ether) or by hanging, drowning, &c., can best be treated successfully by artificial respiration by means of the pneumatic apparatus. In such cases the respiratory tube of the apparatus must be placed in communication with a catheter introduced either into the trachea or into the larynx, if we would ensure that the air, driven in under greater or less pressure, really enters the lungs; otherwise it may pass into the stomach or immediately flow out again.

Fischl reports a case in which he restored a person to life who had been asphyxiated by carbonic oxide gas, through the application of artificial respiration by means of the pneumatic apparatus. Cron, Geigel, and Waldenburg expressed the wish that pneumatic apparatus should always be ready at hand for such purposes in life-preserving stations, operating rooms, clinics, &c.

3. Lastly, the exchange of gases in the lungs may be insufficiently accomplished, although the respiratory force is



undiminished or even increased, from the presence of serious or irremovable obstacles to the penetration of air into the lungs.

In this case the inspiration of compressed air, which is almost exclusively employed in all forms of such disturbances, can only relieve symptoms and allay the craving for air, as sufficient air, if it is compressed to a smaller volume than penetrates in the respiration of ordinary atmospheric air, will still enter the lungs by the stenosed parts of the air passages. The adjustment of the intrapulmonary pressure within the lungs to that of the external atmosphere is at once shown in such cases, as the increased inspiratory efforts and the contractions of the more yielding parts of the thorax caused by diminished pressure within the lungs immediately cease. Under this head come—

1. *Stenosis of the Larynx and the Trachea.*—Waldenburg has reported several cases of syphilitic tracheal stenosis, syphilitic laryngeal stenosis, and paralysis of the dilators of the glottis, in which the inspiration of compressed air was of essential service and the dyspnœa instantly diminished, so that tracheotomy became unnecessary and time was gained for further treatment (by means of dilatation, electricity, medicinal agents). Störk adduces a remarkable example of a yet more favourable result obtained by suitable employment of the pneumatic apparatus. Störk performed tracheotomy in a case of aggravated syphilitic laryngeal stenosis, and profuse hæmorrhage followed; the woman constantly coughed up large quantities of blood, and râles began to be heard. The blood gradually filled the smaller bronchi, and the situation became more and more desperate. Störk rapidly introduced a tracheal tube into the windpipe and attempted to pump out the blood with a syringe, but without success. The patient was sinking rapidly, became pulseless, cold, and life seemed to be definitively ebbing out. Störk then introduced a larger tube into the trachea as far as its bifurcation, and connected it with his apparatus, which was at hand; and at first performing artificial respiration brought out a number of long strings of coagulated blood. Some seconds later, when no more coagulated blood came out, Störk caused the patient to attempt artificial inspiration and expiration from the apparatus, and had the satisfaction of seeing her gradually recover.

2. *Croup and Diphtheria.*—Pneumatic treatment has been tried in these diseases also where it was evident from the first that, as in laryngeal stenosis, the influence must be continued till time had been gained for treatment or the obstruction to respiration had been removed by the further course of the disease. J. Hauke at first tried inspiration of compressed air with his apparatus in laryngeal and tracheal croup, but gave up the attempt in a short time, as he was not able to obtain any favourable results in these diseases. The patients who come under treatment in these complaints are mostly children, and they are either too awkward or too perverse for the apparatus to be used with any success.

In diphtheria Hauke has recently employed the inspiration of compressed air heated up to 45° C., in order to induce, in accordance with my process, rapid suppuration and elimination of the fibrinous deposits. Waldenburg thought good results might be expected from condensed air mixed with oxygen, and challenged experiments in that direction.

The risk involved in these methods is, that by inspiration of compressed air, especially in croup, the force of the inflowing air may tear away shreds of the croupous membranes and convey them into the deeper bronchi, and so set up broncho-pneumonic processes.

3. We might also mention in this place asthma, in which, in consequence of vasomotor influences on the vagi, acute swelling of the bronchial mucous membrane may occur as a result of the distension of the blood-vessels, and thus both inspiratory and expiratory insufficiency be induced.

We must, however, refer to a special chapter for the treatment of this disease, on account of its own importance and its connection with other pulmonary affections.

## 2. *Chronic Bronchial Catarrh.*

Pneumatic treatment and the mechanical pressure it involves, simple enough in respiratory insufficiency, becomes less so in affections of the several parts of the respiratory apparatus. Whereas in the former case the only object was to promote the free exchange of gases, which was more or less impeded, to

convey fresh respiratory air to the lungs, to pump out the exhausted carbonised air from the lungs; in the latter the pathological changes of the diseased part itself, and the consequent functional disturbances, have to be overcome and restored to their normal condition.

We shall consider first chronic inflammation of the bronchial mucous membranes, chronic bronchitis, bronchial catarrh attended with increased mucous secretion, tormenting cough, and often very cyanotic appearance of the patient.

The removal of these disturbances will, according to their special character, require a difference in the mechanical conditions acting on the affected parts, an increase or a diminution of pressure; an augmentation of the force with which the air flows into or out of the lungs will be required, and this of itself tends to promote pulmonary ventilation and an increased supply of oxygen. There is no doubt that chronic bronchial catarrhs, even when they are obstinate and long-established, are favourably influenced by pneumatic treatment; all are agreed on that point who have had any experience of the mechanical treatment of lung diseases. The pressure which compressed air exerts upon the swollen hyperæmic bronchial mucous membrane has in the first place an antihyperæmic and anti-phlogistic effect; the vessels of the mucous membrane are compressed, their capacity diminished, and the afflux of blood reduced, while its efflux and that of the lymph and the fluids in the tissues is accelerated; thus the succulent swollen tissue becomes compressed, its thickness decreased, its consistency condensed. The secretion of the bronchial mucous membrane is limited by the diminished flow of blood and the increased efflux of the fluids of the tissue, the lumen of the bronchial tubes is widened, and thus a free passage obtained for the inflowing air, so that pulmonary ventilation also undergoes a considerable increase by the increased supply of air thus permitted.

When there is but little secretion in the bronchi and expectoration is difficult, they are permeable to compressed air (unless they are entirely blocked by mucous plugs), and the alveoli beyond them, deficient in air or partly collapsed, can be filled with air of higher tension, and expectoration be thus

facilitated by the increased expulsive power. Where, however, the occlusion of the bronchi is complete and extends lower down, the air can no longer penetrate between the mucous plugs and the bronchial walls into the periphery of the lungs, and such an intention was based upon a thoroughly unphysical conception of a purely mechanical process occurring under the given conditions. The compressed air will in this case act not *partially* upon the mucous masses filling up the narrow bronchial tube, but *generally*, as well upon the bronchial walls as upon the whole transverse section of the obstructing mucous mass, and simply drive it farther into the tubes, just as compressed air raises the column of liquid in the water or mercury manometer and does not flow up between it and the wall of the glass tube. Expectoration is promoted by expiration into rarefied air, first according to the simple physical process that, the pulmonary air still standing under high tension, through the lowering of the air pressure in the apparatus with which it is brought into communication the hindrances to its outflow are removed, just as the impediments to its inflow are removed by compressed air. Practical experience confirms this theory. Patients who when previously inspiring compressed air expectorated with difficulty, and were scarcely at all relieved by the ordinary medicinal agents, have, according to Schnitzler's observations and my own, expectorated copiously and easily each time after expiration into rarefied air and have been considerably better for it.

According to Biedert's experience (v. supra) compressed air acts also as an excitant, and therefore as an alterative, upon chronically swollen and hyperæmic mucous membranes. The flaccid capillaries are excited to contraction, the circulation of the blood re-animated, and stasis removed. The action of compressed air must therefore be avoided in recent inflammations, and must not be employed till the acute stage is passed. Still, as Cron's observations show, the irritative effect may be allayed by warming the compressed air before inspiration, and combining it with some soothing agent, such as the vapour of hot water charged with sal ammoniac. Expirations into rarefied air, whether employed simply or in combination with compressed air by the intermitting or alternating method, have a still more stimulating effect on the mucous membranes,

and by compression and dilatation of the vessels excite a vigorous flow of blood and overcome the existing venous stasis and serous infiltration. Biedert therefore refers the favourable results obtained by Störk and others in the treatment of torpid chronic bronchial catarrhs by the intermitting method simply to its stimulating influence, and Schnitzler's observations on the use of expiration into rarefied air lead to the same conclusion, as it does not by any means act anti-hyperæmically, but rather promotes the supply of blood, and the relief of expectoration which Schnitzler speaks of obtaining does not in itself secure the healing of the catarrhal process.

In addition to this influence of the inspiration of compressed and expiration into rarefied air upon the local process, the dyspnœa which attends most cases of chronic catarrh is removed by the dilatation of the respiratory region in the manner already mentioned, as well as by the promotion of pulmonary ventilation generally; the cyanotic appearance disappears; the vital capacity and the pneumatometric values are not infrequently considerably increased. The cough is lessened by the diminution of the secretion, and the coarse and fine crepitant râles disappear from the lungs; the general health, frequently so prostrated by chronic bronchial catarrhs of long standing, is improved, and soon after each sitting a subjective feeling of comfort comes on and continues for some time. The effect of pneumatic treatment of chronic bronchial catarrh is in the majority of cases permanent; the catarrh is frequently entirely overcome; a palliative alleviation is obtained in all cases, even when the catarrh itself is incurable and is only a complication of another more deeply seated pulmonary or cardiac affection.

Sommerbrodt has reported the most favourable results of pneumatic treatment, especially from the inspiration of compressed air; long-established bronchial catarrhs which had hitherto defied all remedies were often cured by inspiration of condensed air in a few sittings. Hänisch also succeeded in improving and even completely curing chronic bronchial catarrhs of long standing by the influence of compressed air after 5 to 8 sittings, and Störk obtained by the intermittent method results which could not have been attained with the same certainty in any other way, whereas Biedert and Schnitzler,

although they do not announce such remarkable results, nevertheless assert that by this treatment many protracted cases of bronchitis may be rapidly cured. On the other hand it is quite possible that a case of catarrh complicating phthisis or emphysema may be considerably aggravated by inattention to the irritative influence of air pouring in under high pressure. Waldenburg has not been able to report any such brilliant successes, but was frequently disappointed with the results of pneumatic treatment in many cases of bronchial catarrh, so that eventually he relied more on medicated inhalations developed by means of the spray producer.

Lastly, volatile medicines are used in the manner already mentioned in combination with compressed air in treating these bronchial affections, such as ethereal oils, certain hydrocarbons, balsamic bodies generally, ol. pini silvestris, ol. pini pumilionis, ol. terebinthinæ, acid. carbolicum, and sal ammoniac in hot aqueous solution. It is generally chronic catarrhs with copious secretion, which indicate the employment of balsamic and astringent remedies, and this is the case especially when the secretions have accumulated in large quantities in the dilated bronchi and bronchiectatic cavities, and are then undergoing putrid decomposition. In these last cases the best results have followed the concomitant action of chemico-pharmacological and mechanical agents, whereas these combined methods have proved but of little value in all other forms of bronchial catarrh. It must not, however, be forgotten that in these inhalations an additional irritant is combined with that of increased pressure of inspiratory air, and as an example of the mischief which may result from this treatment I may mention a case of Biedert's, in which, after the second inhalation of 30 drops of a 2 per cent. solution of carbolic acid in glycerine (out of the *Medicamentenköcher*) in slightly compressed air, dangerous double-sided pneumonia ensued, for which no other cause could be assigned. I therefore prefer, in cases in which the influence of chemical substances appears necessary, in combination with the pneumatic treatment, to order medicated inhalations with the pulveriser or simple steam apparatus, to be used twice or more frequently in the day, according to the severity of the case, in the intervals

between the pneumatic sittings. It will always be more advisable in the majority of cases to apply these two therapeutic methods separately, especially when the energetic administration of inhalations of the ethereal oils above mentioned is indicated, as large quantities of them are better tolerated in combination with warm aqueous vapours than with compressed air. The effect of aqueous vapour thoroughly saturated with these is much more energetic, while the danger incurred by their streaming into the lungs under increased pressure is avoided. It is only where all the conditions are favourable that we are justified in acting less cautiously.

The application of compressed and rarefied air must be determined by the form or severity of the case.

Kelemen looks for general indications in the respiratory insufficiency of the lungs as revealed by the pneumotometer. He therefore considers expiration into rarefied air indicated in cases in which expiratory insufficiency is detectable, while chronic bronchial catarrhs, in which this is not present, call for inspiration of compressed air. Chronic bronchial catarrhs with moderate secretion are generally rapidly improved or completely cured by inspiration of air compressed to  $\frac{1}{80}$  to  $\frac{1}{60}$  excess atmosphere pressure daily with 1 to 2, 3, or 4 sittings of 30 to 60 respirations. In torpid catarrhs and in catarrhs with slight secretion the most favourable result will be obtained by the alternate application of raised and lowered air pressure by the alternating or intermittent method. Where two gasometer apparatus are available, expiration into rarefied air should follow immediately upon inspiration of compressed air, and these alternate respirations should be continued for about an hour. With the water-engine bellows it is best to begin with  $\pm$  pressure of 6 centimetres, and rise to 16 to 20 or 30 centimetres, returning gradually to normal respiration at the close of the sitting. Where there is only one apparatus let the patient inspire 1 to 2 cylinders full of compressed air of suitable pressure and then expire into 2 to 3 cylinders of air somewhat more highly rarefied, and close the sitting with 30 to 40 inspirations of a slightly compressed air—the whole to be repeated 2 to 3 or 4 times in the day. In expiratory insufficiency, or when there is abundant secretion, and especially

when we want to remove the mucous masses accumulated in the bronchi, expiration into rarefied air will effect to some extent the free removal of the increased residual air, and so promote rapid expectoration and also exercise an alterative influence on the tissue of the mucous membrane by excitement of the vascular system. The sittings in which 3 to 4 cylinders are expired must take place 2 to 3 times in the day, seldom more, and if the catarrh after 10 to 12 or more days improves, if the respiratory force increases and the expectoration becomes less and is easily discharged, inspirations of compressed air may be gradually combined with the expirations, so that at first each sitting is closed with 30 to 60 inspirations of slightly compressed air and then gradually the patient passes to the intermittent or alternating method. Finally, only inspirations of compressed air with  $\frac{1}{6}$  to  $\frac{1}{5}$  atmosphere excess pressure are employed, and the treatment is brought to a close.

When the impregnation of the air with volatile medicinal substances seems necessary, they must, according to the construction of the apparatus, either be dropped on cotton wool or mixed with water and introduced into the receptacle through which the compressed air passes, or through which the air must pass in the filling of the cylinder. 5 to 6 drops of ethereal oils (ol. pin. silv., ol. pin. pumil., ol. terebinth., &c.), and in inhalations of spirituous carbohc solutions 1 : 5, would appear enough for one sitting. Sal ammoniac is used in concentrated, hot, aqueous solution with which one or two combined Wulff's flasks are filled about one-third, and, according to its chemico-pharmacological properties, exercises a soothing influence on the bronchial mucous membrane and promotes expectoration.

### 3. *Acute Bronchial Catarrh.*

Acute bronchial catarrh has hitherto been rarely submitted to pneumatic treatment, as the acutely inflamed mucous membrane reacts too sensitively to the action of compressed air.

Cron only has published statements to the effect that the action of compressed air, when it was saturated with warm aqueous vapours charged with sal ammoniac in the manner



demonstrated above, was not only tolerated by the mucous membrane without any appearances of reaction, but that also the most violent and obstinate cases of bronchitis were at once cured rapidly and agreeably. When the affection is specially localised in one lung Cron, in order to act upon it more surely and energetically, causes the patient to lie on the healthy or least affected side and to inspire in that position.

The depth of the inspirations, the height of the air pressure, the strength of the solution of sal ammoniac, its temperature and that of the compressed air, must be adapted to the special case according to the existing indications.

#### 4. *Emphysema.*

Pulmonary emphysema presents the most favourable object for the physical action of diminished intrapulmonary pressure on the inner surface of the lungs and the pulmonary blood vessels by means of expiration into rarefied air. So far as the changes in this affection of the lungs and the disturbances resulting from them are of a physical nature, they will be capable of a more or less complete restoration, but the changes arising from disturbances of nutrition are also accessible to mechanical treatment, unless the pathologico-anatomical conditions are irreparable.

The characteristic physical changes in pulmonary emphysema are :—

1. Enlargement of the thorax in all its dimensions by widening of its circumference and by displacement of the adjacent organs from their normal situation, depression of the diaphragm, liver, abdomen, spleen, dislocation of the heart and of the great vascular trunks, as the result of

2. The proportional increase in volume of the lungs in consequence of dilatation and distension of a number of air cells, proportionate to the increase of volume, without any tissue increase or inflammatory infiltration of the parenchyma ;

3. Increase of the air retained in the lungs by accumulation of respiratory air in the dilated parts ;

4. Diminution of the elasticity of the pulmonary tissue in consequence of the increase in volume of the air remaining

behind in the air cells and the consequent increase of the pressure which it exercises upon their walls.

Immediately connected with these physical changes and disturbances in the emphysematous lungs are the disturbances of nutrition which gradually develop and rapidly advance in them, and the pathologico-anatomical changes which ensue from these, and the consequent steady decrease of the power of resistance of the tissues. By the pressure which the increased volume of air exerts on the walls of the air cells, first the capillaries in their walls and later on those also situated in the septa between the air cells become compressed, and the blood supply as well as the escape of nutrient fluid into the tissue is diminished. The consequent diminution of the nutrition of the affected parts of the tissue has for its direct result a decrease of the resistance of those parts to the increasing rise of pressure of the steadily growing quantity of air in the air cells, and a diminution of the contractility of the elastic tissue already gradually giving way under the advancing pressure. The contraction of the lungs during expiration thus becomes more and more incomplete, the accumulation of the residual air greater and greater. The initially compressed vessels, the more superficial capillaries, become occluded, deeper-lying and larger vessels are drawn within the range of the pressure action, larger and larger regions become obliterated and lead to diffuse anæmia and inanition of the whole lung. Finally, in the parts most exposed to pressure, and where the nutritive disturbances were first developed, all the nutrient vessels become completely obliterated, the walls of the air cells become atrophied, and emphysematous pouches of greater or less extent are formed, which are perfectly useless for respiration and reduce still more the contractile power of the lungs. It is needless to say that changes of this kind are irremediable.

The possibility of removing by mechanical means the physical changes and disturbances of nutrition in emphysematous lungs involves also the getting rid of functional disturbances and subjective symptoms, if they are not the result of consecutive irreparable change of tissue.

An immediate result of the abnormal dilatation of the pulmonary air-cells, by which the contractile power of the elastic

tissue has more or less suffered, is the accumulation of respiratory air within them and the more and more incomplete evacuation of this air from the lungs; the breathing becomes laboured, especially if, in addition to the physical changes, the exchange of gases is more and more hindered by obliteration of the capillaries and gradual atrophy of the pulmonary tissue. Expiratory insufficiency ensues; inspiration is less interfered with, especially in the first stage of the disease, and it would even be facilitated if it was only a question of diminished elasticity; but as the lung can no longer retract sufficiently in expiration on account of the decrease of its elasticity, and the thorax cannot contract, the excursion of the thorax will also be less in the subsequent inspiration, and the dilatation and filling of the lungs with fresh air will thus be diminished. Dyspnoea will be almost constant in emphysema by reason of the decreased supply of oxygen and accumulation of carbonic acid in the respiratory air. Finally, first in consequence of the compression of the pulmonary capillaries and later on of the obliteration and atrophy of a greater or less portion of them, the efflux of the blood from the right heart is checked, dilatation and hypertrophy develop, with engorgement in the venous system, and, the decarbonisation of the blood being considerably diminished, cyanosis sets in. Secondary renal affections and general dropsy usually close the series of the processes following upon emphysema.

Expiration into rarefied air opposes a completely definite sum of physical influences to the physical changes in the lungs with almost mathematical exactness, and removes the symptoms of the disease so far as they are not the result of destruction of the tissues; for the emphysematous lung during expiration into rarefied air is in communication with an air receiver, in which

1. A negative pressure, determinable by weights, can be exercised upon the lungs, and in which

2. Air is contained of less density than the pulmonary air.

Therefore in expiration not only will that air be removed which would have been exhaled in expiration into the ordinary atmosphere in consequence of the retraction of the lungs, but also so much of the residual air as is equivalent to the negative pressure applied and the cubic capacity of the section of the cylinder drawn up.

The efflux of air from the lungs occurs, as in the air pump, according to the formula  $x = \frac{d \cdot b}{a + b}$ , so that at the close of expiration, if the lung remains a few seconds longer in communication with the apparatus, the intrapulmonary pressure of the pulmonary air is equal to the pressure of the expired air in the cylinder to be read off on the manometer. While a portion of residual air is thus pumped out, and the pressure on the inner surface of the lungs thereby lowered, and the normal atmospheric pressure, now relatively higher, acts upon the surface of the thorax, the lung also retracts, in equal proportion, to a smaller volume, and the capillaries spread over its inner surface, as well as the pulmonary blood-vessels generally, will dilate and become more completely filled with blood as they experience the suction influence of the apparatus. Here purely physical influences are opposed to physical disturbances—reduction of volume to increase of volume, retraction and lowering of pressure to expansion and raising of pressure, withdrawal of air to accumulation of air. By repeated expirations into rarefied air, by prolongation of the length of time over which they act, and by increase of the negative pressure, more and more air is withdrawn from the lung, the intrapulmonary pressure is further lowered, the lungs are brought to the greatest possible retraction, and by permanent dilatation of the pulmonary blood-vessels an increased flow of blood is kept up, so that anæmia and disturbances of nutrition in the lungs are removed, and the influence which they exercise in the emphysematous affections is eliminated. The result of this pneumatic treatment is complete and permanent; the physical changes of the lungs are entirely restored to the normal, and this form of emphysema permanently cured. But even where destruction of the tissue has already commenced, where large portions of the pulmonary tissue are atrophied, and more or less of the septa of the air cells obliterated, a partial cure may be effected by expiration into rarefied air, and the emphysematous lungs reduced in volume, since these advanced pathologico-anatomical changes never stretch over the whole pulmonary tissue, but are diffused in an alternating manner with portions which show only the

initial, simply physical disturbances. Though those parts of the lungs which exhibit these physical changes in the initial stage can be restored to the normal, no favourable changes take place in the atrophied parts long incapable of respiration, but they may even undergo a partial dilatation from the mechanical reduction of volume and retraction of the other parts. This secondary dilatation of completely insufficient parts does not in the least interfere with the reduction in volume of the entire lung, which is generally considerable.

Even after a few respirations with the apparatus the patient feels material relief; with each expiration a part of the residual air is removed, and every inspiration brings a larger quantity of fresh respiratory air into the lungs. The rapidly proceeding pulmonary ventilation eliminates the previous difficulties of breathing and dyspnoea, and a condition of comfort ensues, which is maintained for a long time. This was observed in the case of almost all patients without exception, even where the emphysema of many years' duration had already led to advanced destruction of the lung tissue. The influence of expiration into rarefied air upon the respiratory process is not only subjectively observable to the patient, but can also, as Hänisch has shown, be objectively demonstrated by Riegel's stethographs.

The observations here given refer to the case of a woman 53 years of age, who had suffered for years from aggravated emphysema and dyspnoea. Whereas the abdominal curve A (fig. 69), taken before the beginning of the treatment, was marked as a perfect emphysemal curve, the influence of mechanical agency on the respiratory movements is unmistakably shown in curve B, which was traced the same day after three cylinders full had been expired under a negative pressure of  $\frac{1}{3}$  atmosphere.

In curve A the wave-like ascent and descent of the normal curve is wholly absent, the transition from inspiration to expiration is quite sudden, expressing itself in an acute angle. The expiration, at first proceeding rapidly and with little hindrance, is in its last part laboured, much interrupted, and of unequal rapidity; we recognise the likeness of a jerky expiration. On the other hand, in the curve B the angle of transition

of the inspiratory into the expiratory line is less acute, and even though expiration does not occur quite evenly it is no longer so broken as before. This effect is still more markedly expressed in the following curve *c*, which was traced after about four weeks of treatment, but previously to the beginning of expiration into rarefied air. This curve shows the wave-like behaviour observed in the normal condition; the angle at which the inspiratory line passes into the expiratory is no longer acute, but obtuse, or more correctly it is no longer an angle, but a curved line. The expiration is not yet quite even; the expiratory line does not yet fall gently downwards in one

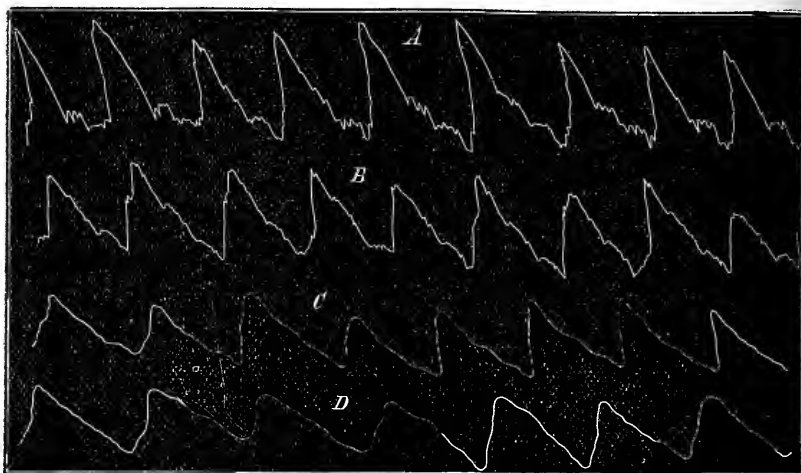

FIG. 69.

unbroken line, but the coarser interruptions formerly existing are nowhere to be seen, and the inequalities in the last phases of expiration are nearly extinct. Lastly, in the same day, immediately after the expirations into rarefied air, the last curve *D* was taken. It presents perfectly normal conditions. The inequalities still clearly observable before the expirations have disappeared after them, so that, together with steadily advancing improvement the direct influence exercised upon the respiratory movements by expiration into rarefied air is clearly displayed.

If pneumatic treatment is carried out in this way, with

gradual increase of the negative pressure and of the frequency and length of the sittings, the other objective signs of advancing improvement will soon be physically detectable, and can be clearly estimated by steadily increasing numerical valuations. The position of the abdomen generally alters after even a few sittings, by the progressive retraction of the pulmonary tissue, under the diminishing intrapulmonary pressure, and shows a higher position when percussed; the cardiac dulness also changes; the lobes of the lung overlying the heart retract more and more, and admit of its being percussed to an increasingly large extent, till the lung at the close of the treatment has moved back from the inspiratory position to the normal or quasi-normal expiratory position.

Auscultation, which previously detected diminished respiration or indistinct respiratory sounds over the greater part of the lungs, and, if there was co-existing bronchial catarrh, occasional rhonchi, with feeble, indistinct cardiac sounds but exaggerated pulmonary second sound, now shows normal vesicular breathing extending over more widely diffused regions, while the catarrhal sounds have diminished; the cardiac sounds also have become stronger and the pulmonary second sound is no longer exaggerated. If a severe affection of the bronchi co-exist, the alternate action of inspirations of compressed air may become necessary, to the employment of which in emphysema complicated with catarrhs we must return in a special section. But the sphygmographic tracings show also in the radial artery how by the aspiratory suction of the rarefied air the lesser circulation is at once more completely filled, with a consequent increase of blood pressure and of vascular tension in the aortic system.

This effect on the circulation, like that upon respiratory movement, can generally be observed after the very first sitting, after the patient has expired three to four cylinders. I had an opportunity in the winter of 1878 of observing the direct influence of lowered intrapulmonary pressure upon engorgement of blood in the venous system, when the residual air is exhausted by long-continued expiration into rarefied air, in the case of an emphysematous patient whose hands began to be œdematous after a severe attack of bronchitis, œdema of the lower extre-

mities having existed for a year. The œdema of the hands disappeared each time that the patient expired for an hour into highly rarefied air under a negative pressure of  $\frac{1}{25}$  to  $\frac{1}{20}$  atmosphere. Over night the œdema appeared again, and for the sake of exact control I administered the expirations at different times of the day, earlier or later; but the swelling remained constant, till by longer continued expiration into rarefied air a sufficient suction of venous blood into the lungs had taken place. If I entirely suspended the expirations for a whole day, the œdema not only remained through that day, but it increased perceptibly the following day, and did not yield till after two to three hours' employment of highly rarefied air. I failed to observe so direct an influence of rarefaction of air on œdema of the lower extremities, so that the suction action of the lungs effected by lowering the intrapulmonary pressure seemed in the first instance to produce a disengagement of the venous system belonging to the superior vena cava, in which the conditions are more favourable to the efflux of blood than in the veins communicating with the vena cava inferior. The greater pressure of the retarded blood in the veins of the lower extremities is also shown by the œdema first appearing in that region, whereas similar swellings in the hands are only observed in more advanced stages of circulatory disturbance. I will return to this case further on.

The increase of lung capacity during pneumatic treatment can be steadily ascertained by comparative spirometric measurements. Even in emphysema of long standing it rises in a short time to 500 to 600 cubic centimetres, and may rise to over 1,000 and 1,200 cubic centimetres and more, while in more recent cases it may increase to the normal height again, with complete restoration of the enlarged lung.

As a result of increasing elasticity of the lungs and augmented capacity, the expiratory force, which generally shows a considerable diminution even under 20 millimetres mercury, gradually increases again and rises to 50 to 70 millimetres and higher, while the inspiratory suction, also enfeebled, gains strength in the same ratio. The pneumatometric estimates may, if the treatment be prolonged sufficiently, quite reach the normal height again, or in the case of incurable patients



remain below it; in every case they will experience a considerable rise.

Lastly, the frequency of respiration is diminished. The respiration, which at starting may be forty and more in the minute, becomes retarded with the increasing depth and freedom of the respirations, till, in concordance with the other physical phenomena, their number ceases to exceed the ordinary frequency.

These are the results which can be obtained in emphysema by expiration into rarefied air, when it comes under treatment uncomplicated with bronchitis.

If the emphysema is complicated with bronchial catarrh, the success of the treatment depends directly on the irritability of the bronchi, as well as on the caution with which the treatment is gently pushed, and, when every effort to employ rarefied air with stronger pressure and prolonged duration is met by increased rhonchi, oppression, and violent fits of coughing, the desired retraction of the lungs is unattainable. In such cases we must begin with a few inspirations of compressed air, twice a day, twenty and thirty inspirations under excess pressure of  $\frac{1}{90}$  and  $\frac{1}{60}$  atmosphere, while at the same time inhalations of sal ammoniac are employed during the day for liquefying the usually viscid, mucous secretion, or where there is abundant secretion of a putrid character inhalations of the vapour of oleum pini sylvestris, or of oleum terebinthinæ, or pulverised carbolic solution should be administered. On the second or third day expirations into rarefied air may be begun in the following manner: After thirty to forty inspirations of compressed air, as many expirations into rarefied air, or else they may be continued till violent irritative cough is excited, and the sitting closes with twenty to thirty inspirations of compressed air. The expirations into rarefied air are gradually increased, because, as a sign of progressive improvement, they do not provoke fits of coughing so readily as before, while the inspirations are gradually diminished in corresponding manner. Lastly, the preliminary inspirations will be first discontinued, then the subsequent ones reduced in pressure and number, and finally the expiration into rarefied air used alone. Where two apparatus or Geigel's double ventilator are at command, it

will be most advisable to employ alternately inspirations of compressed air and expirations into rarefied air, at first under equal positive and negative tensions of air,  $\pm$  pressure about six to eight centimetres water manometer; then, after a few inspirations, to raise the negative pressure above the positive, and with synchronous increase of the tensions of air advance to higher and higher differences, even up to +16 and -30 centimetres; and finally, after these differences have acted upon the pulmonary surface for eighty to one hundred respirations, return with the same gradations in the course of the next forty to fifty respirations to slighter differences, and at last to normal atmospheric pressure.

Cron states that he has employed expirations into rarefied air alternately with inhalations of warm aqueous vapours charged with sal ammoniac with perfectly satisfactory results, in cases in which emphysema was complicated with bronchitis, making impossible the action of rarefied air alone. The compression pressure of the condensed air, which was the vehicle for the inhalations of the aqueous vapours containing sal ammoniac, was made only just high enough to overcome the resistance which the water in the Wulff's flask offers to inspiration, and the inspiration could proceed without any positive pressure. In this way Cron entirely avoids the influence of compressed air, and even considers it to be injurious to the lung in process of expansion, while rarefied air can exert its full influence, till the desired reduction of the lungs is effected by excess pressure from without and emphysematous anæmia is relieved by the suction of blood towards the pulmonary surface, so far as the existing anatomical changes admit.

Senile and vicarious emphysema are quite inaccessible to mechanical treatment, because the first is the result of atrophy of the pulmonary tissue, which is beyond the reach of medical skill, while the thorax, by ossification of the costal cartilages, has become almost or entirely immovable, and is no longer susceptible of any change of form; the latter can only disappear when the parts of the lung for which the healthy lung is acting in excess in vicarious respiration are restored to the exercise of their functions. Yet even in such cases the alternating or the intermitting method, by alternate conveyance of compressed

air and free removal of the residual air by means of expirations into rarefied air, best carried out by Geigel's double ventilator, will be of use in combating the difficulty of breathing, often amounting to severe dyspnœa, and the complicating bronchial catarrhs.

In the mechanical treatment of emphysema, if no complication is present, it is of the first importance that the expirations into rarefied air be carried out under a rapidly increasing negative pressure, as high as can be tolerated under the existing circumstances, and in long-continued, frequently repeated sittings. This is especially the case with emphysema of long standing, which offers the greatest resistance to treatment. Not much will be gained by a few expirations under slight pressure, undertaken twice in the day.

The case cited above shows what can be done. Another patient, a goldsmith at Munich, 38 years old, had suffered since his fourteenth year from asthma and emphysema, and he expired in three sittings of 1 to  $1\frac{1}{2}$  hour 36 to 40 cylinders of an apparatus constructed on Waldenburg's principle, making 40 to 45 expirations to each, so that he undertook in one day 1,440 to 1,600 and 900 to 1,000 expirations under a rising negative pressure of  $\frac{1}{40}$  to  $\frac{1}{20}$  atmosphere. I have proceeded in the same manner with other patients also. In no case have I observed injurious results from long-continued energetic suction of blood into the lungs. In the case of the first patient the œdema in the hands disappeared after 1 to 2 such sittings of 1 to  $1\frac{1}{2}$  hour, and the lung capacity rose from 2,500 cubic centimetres to 3,500, while the expiratory pressure rose to 60 millimetres and the inspiratory suction rose to 70 millimetres mercury.

At the commencement of the treatment we begin with 3 to 4 cylinders, and then rise rapidly to 6 to 8 or 10 in a sitting; this is repeated 3 times a day, morning, noon, and evening, while the negative pressure rises slowly from  $\frac{1}{60}$  to  $\frac{1}{40}$  or  $\frac{1}{20}$  atmosphere, and the higher it goes the longer will it be maintained, 10 to 14 days, or even 2 to 3 weeks. The duration of the treatment itself will stretch over weeks and months, according to the severity of the case, till a satisfactory constant result is obtained—that is, either a complete cure, or

we find the retraction of the lungs makes no further progress after repeated thorough physical examination. In the latter case it will be necessary after a longer or shorter interval to repeat the treatment for 3 or 6 months, as a renewed attempt after a long pause is generally effectual; or, if physical examination detects a fresh inflation of the lungs, especially in cases of long standing, to counteract it at once by withdrawing air. How often the repetition is to take place depends upon the definite result of the physical examination and the individuality of the patient.

If bronchitis exists as a complication, the treatment must follow the method above described, and if asthma is developed together with bronchitis the desired result will be obtained in a short time by intermittent or alternate respiration, especially by the use of Geigel's double ventilator, with higher pressure as rarefaction or with equal degrees of tension. Even in the first sittings the respirations become gradually deeper and freer; incitement to coughing, which, in partial expiration into rarefied air, so often disturbs the sitting, occurs much less frequently, and the patient feels much easier under the influence of increased ventilation of the lungs, especially if suffering from dyspnœa. It happens not unfrequently that asthma and bronchitis disappear completely after a few sittings; the actual treatment of the emphysema cannot of course be commenced with the necessary energy till these complications have receded. If the emphysema is complicated with asthma without bronchitis the treatment will be the same as in asthma dependent on bronchitis with emphysema, but the result is less successful and is often wearily protracted, fluctuating between improvement and relapses.

The treatment of emphysema must therefore, according to the principles we have laid down, be carried on in the intervals between the asthmatic attacks.

##### 5. *Bronchial Asthma.*

It is more difficult to fix the indications for the mechanical treatment of pure, idiopathic bronchial asthma existing independently of bronchitis or emphysema.

It is absolutely necessary in the first place to ascertain

clearly what effect can be produced upon the affected organs, and therefore what is to be our aim in applying mechanical treatment to this disease, with reference to its etiological conditions and their symptomatology, and more especially with regard to its course and the sequence of the consequent phenomena. Since it is impossible in this case to calculate so exactly, and obtain results so rapidly, as in other affections of the respiratory organs; to set aside on that account mechanical treatment in bronchial asthma and to trust to other remedies which are evidently utterly inefficacious except for temporary narcotisation, or for stimulating expectoration and palliating the violence of the attacks, would be an error which would speedily revenge itself by the gradual development of the secondary changes in the bronchi and the lungs as sequelæ of the asthmatic paroxysms.

The group of symptoms which are developed in pure asthma is no doubt to be referred to an acute swelling of the bronchial mucous membrane in consequence of the distension of its blood-vessels by vasomotor influences acting through the vagi. The profuse secretion of sero-mucous fluid into the finer bronchi does not occur before the attack, but after it has lasted some time or towards its close, and arises from an abundant flow of blood to those terminal parts of the lungs in which, owing to the violent inspiratory dilatation of the thorax during the occlusion of the bronchioles, inflation and rarefaction of air or consequent secondary exudation of serous fluid appears. The swelling and the profuse secretion which are partly to be regarded as purely physical processes are not of a simple catarrhal character, and the asthmatic attacks are not to be referred to the influence of such a process alone. It would certainly be more favourable if the closure of the finer bronchi and the profuse secretion into them were only the result of an acute catarrhal swelling, which could easily be removed by the action of compressed air. However, even in spasmodic contraction of the bronchi it is not against the cause of the disease itself that the inspiration of compressed air is directed, but directly against the mechanical processes arising immediately out of the occlusion of the bronchi. By inspirations of a strongly compressed air, air of greater density and

rich in oxygen is forced through the contracted bronchi into the parts of the lungs situated behind the stenosed places, and thus the arrested exchange of gases is again renewed and the dyspnoea relieved, while the inflation of the air cells is checked by the cessation of the forced inspiratory movements, and the rarefaction of air within them prevented. Waldenburg in this manner succeeded in cutting short the asthma in its less violent paroxysms by inspiration of compressed air; Geigel also observed decidedly favourable results from the inspiration of compressed air in violent asthmatic attacks which were in part due to disturbances in the pulmonary circulation from non-compensated insufficiency of the mitral valve. It is to be borne in mind, however, as a set-off against these results, that compressed air always acts as an irritant and exercises an exciting influence upon the mucous membrane of the bronchioles, which is intolerable under some circumstances, and not only interferes with the removal of the resistance in the contracted bronchi and the penetration of larger or smaller quantities of condensed air into the distended air-cells, but may excite them to firmer closure by increased muscular contraction and entirely do away with the effect of the inspirations. For this reason pneumatic treatment can very seldom be carried out in violent asthmatic attacks. Biedert treated such patients successfully with air impregnated with amyl nitrite, 4 drops at a sitting, or during the attacks benefit has been derived from fumigations with stramonium, cannabis indica, nitre paper (cf. 'Chemical Part'). As in purely nervous asthma there is not only inspiratory but also expiratory insufficiency, it is generally necessary to withdraw the air driven into the terminal parts of the lungs by the inspiration of compressed air, as well as the residual air; therefore expiration into rarefied air must each time follow inspiration of compressed air, either intermittently or better alternately; in the former case 20 to 30, 60, or 100 inspirations of air compressed to  $\frac{1}{30}$  to  $\frac{1}{50}$  atmosphere excess pressure must be followed by an equal number of expirations into rarefied air, at first up to  $\frac{1}{50}$ , later on up to  $\frac{1}{40}$  to  $\frac{1}{30}$  atmosphere negative pressure, closing with a few inspirations of compressed air of equal density; or in the latter case alternate inspirations of compressed air with expirations into rarefied air, under the

above-given amounts of pressure, immediately succeeding one another by the use of two simply or doubly acting apparatus, or Geigel's double ventilator, so that the compressed air driven in by inspiration may be at once pumped out again by expiration into rarefied air and a thorough ventilation of the lungs restored.

Where mechanical treatment is not tolerated, as occurs unfortunately in a great number of cases, the mode of treatment described above must be reserved for the free intervals and ordered two or three times a day, with gradual prolongation of the several sittings, by increasing the number of inspirations and expirations. According to Waldenburg compressed air also exercises a favourable influence during the free intervals, by expanding the thoracic space and bringing the lungs permanently nearer to the medium inspiratory position. Waldenburg asserts that inspiration of compressed air effects this without danger to the pulmonary tissue, whereas, he says, nature achieves it by gradually developing emphysema, and this tendency of asthma is thus compensated; he has always succeeded by this method in giving relief, and in producing longer intervals between the several attacks. He also recommends expiration into rarefied air, in the same intervals, for promoting retraction of the lung tissue.

Emphysema, with all the conditions dependent on it, is induced even in pure bronchial asthma without any special expiratory hindrances, owing to the inflation of the lungs in inspiration, resulting from the disproportion between the inspiratory effort and the change of air obtained. When the attacks are frequent and intense, its appearance is not generally long delayed. We learn how considerable the acute inflation during an asthmatic attack may be from a case observed in consultation by Biedert, that of a woman suffering from chronic pericarditis, who had had violent asthmatic attacks for two to three months. Biedert himself unfortunately never had an opportunity of witnessing an attack; but the physician in charge of the case, Dr. Dalquen of Guntersblum, assured him that during the attack the lung became enormously distended, and the cardiac dulness, usually very evidently increased, altogether disappeared. As in this case there was not a trace of

dilatation of the lung in the interval, and no actual affection of the lung was clearly detectable, the case can only be accounted for by inflation caused by spasm of the bronchial muscles. Expirations into highly rarefied air during the attack produced very satisfactory results. When once emphysema has been actually developed inspiration of compressed air, in the subsequent bronchial asthmatic attacks, no longer produces the beneficial effect which it formerly did, and an alternating expiration and inspiration procures relief in the early stage of the attack, or, when dyspnoëic troubles occur as sure forerunners of an asthmatic attack, it may be warded off by expiration into rarefied air.

Of course in the free intervals the retrogression of the emphysema is to be regarded as the main object of pneumatic treatment, especially because, according to the observations in our possession, the same treatment is attended with favourable results on the number, duration, and intensity of the asthmatic attacks themselves. Either alternate or intermitting inspirations of compressed air and expirations into rarefied air are indicated, or if no complications are present, as my own observations confirm, expirations into rarefied air and rapid increase of negative pressure, as recommended in the treatment of emphysema. If the situation should be complicated with bronchial catarrh, in this case the catarrhal condition of the bronchial mucous membranes must be counteracted by the pressure action of compressed inspiratory air and a treatment similar to that in the above-mentioned complicating affections commenced. The expirations into rarefied air must therefore be diminished in number and insensibly replaced by alternate inspiration and expiration; in individual cases, when necessary, inspirations of compressed air alone or in combination with warm aqueous vapours impregnated with sal ammoniac may entirely take their place.

Lastly, those cases remain to be mentioned in which mechanical treatment appears to be ineffectual—i.e. in which neither the action of inspiration of compressed air or of expiration into rarefied air, or of a combination of both is tolerated—and this treatment, when applied during the free intervals, produces no perceptible effect on the number or duration or inten-



sity of the attacks. In these cases the danger of consecutive emphysema and bronchial affections is imminent, since the attacks, as usually occurs, come on with special violence, and the patience of the invalid and the perseverance of the physician both give way under the apparent hopelessness of the variety of therapeutic efforts employed. Here a steady pursuance of the pneumatic treatment, and especially of the alternating or intermitting methods, must be insisted on, as, owing to the extreme intensity of the inspiratory and expiratory insufficiency (one needs only once to have observed such cases), the emphysematous inflations of the lungs, the bronchial catarrhs, and capillary bronchitis, with the other disturbances attending them in the respiratory and circulatory apparatus, frequently develop in an astonishingly short time. In the present state of medical science there is no justification for the adoption of sedatives or general treatment of any kind, of which it is known beforehand that they are incapable of warding off the threatening lesions of the lungs.

#### 6. *Pleuritis and Empyema.*

It is in the treatment of pleuritic exudations and empyema that the highest degrees of compression of the inspiratory air are employed. The object aimed at in pneumatic treatment of these affections is to bring about a rapid increase of intrapulmonary pressure, and so mechanically accelerate the absorption of the fluids exuded into the pleural sac, as well as to relieve the compressed conditions of the lungs dependent on the formation of false membranes and the consequent thoracic deformities. As the lung tissue is usually healthy and the capacity of the air cells is not only more or less diminished by pressure of the exudation on one hand and displacement of the heart and the great vascular trunks on the other, but their expansibility is also generally considerably impaired in normal inspiration as well as under increased pressure, so that there is no danger of emphysematous inflation or laceration of the tissue by the increased partial pressure, therefore degrees of pressure can be employed and tolerated which could not be applied under any other circumstances without considerable injury to the lung tissue.

Since it is the diseased products which are the object of mechanical treatment, and not the inflammatory process which gives rise to them, it must not therefore be attempted till the inflammation of the inflamed tissue and the fever have subsided, viz. not till after the third or fourth week, when the patient is in a state to bear the irritation caused by the penetration of the compressed air into the lungs, and the lungs themselves are capable of bearing the alterations in pressure and fulness of the blood-vessels resulting from inspiration and expiration. The nature of the inflammation itself and the character of the exudation deposited by it materially affect the result as well as the course of the malady. Where pathological changes are present in the lung and the pleura, which in themselves are not capable of retrogression, mechanical treatment cannot effect a thorough cure, but even in this case a palliative influence, in relieving insufficiency of respiration by introducing larger quantities of air in a condensed form, by stimulating pulmonary ventilation, by the anti-hyperæmic and absorption-promoting influence of increased intrapulmonary pressure upon chronic inflammatory processes, infiltrations, and exudations, is more beneficial than any other mode of treatment.

The most favourable cases for the action of pressure are those of simple serous exudation, the absorption of which occurs most rapidly under pneumatic treatment. Here high degrees of pressure are exceedingly well borne, and it can therefore be rapidly raised without danger of any ill-effect. Even when the pleural surfaces are covered with fibrinous deposits the retraction and atrophy of the lung tissue are arrested by the gradual dilatation of the more or less compressed lungs by the increased pressure, and as, when the treatment is begun early, the re-expansion of the lung tissue goes on *pari passu* with the absorption of the fluid constituents of the exudation, and an intrapulmonary excess pressure counteracts the normal atmospheric pressure weighing upon the thoracic surface, consecutive thoracic changes, sinking-in of the movable walls of the thorax, and curvature of the spine are arrested in their development. Only where such exudations are suspected no time must be lost in the employment of the pressure, and far more numerous and prolonged sittings must be insisted upon

than is usually the case. The sittings must last at least half an hour to an hour, and be repeated three or four times and even more frequently in the day, so that from 20 to 30 cylinderfuls, and perhaps even more, of air compressed to  $\frac{1}{40}$  or  $\frac{1}{30}$  atmosphere excess pressure are inspired.

If the exuded fluid is withdrawn by thoracentesis a more complete emptying of the pleural cavity may be effected by the inspiration of moderately condensed air ( $\frac{1}{80}$  to  $\frac{1}{60}$  atmosphere) into the compressed lungs during the operation or towards its close, where it is tolerated; while also by the filling of the pulmonary air-cells with condensed air a sudden inordinate fulness of the pulmonary vessels, in consequence of the rapid emptying of the pleural cavity, will be avoided. Through the increased pressure of the pulmonary air the pleural surfaces are caused to approach closer to one another after the withdrawal of the exudation, and by the freeing of the pulmonary circulation fresh exudations are best counteracted.

In the subsequent course of the case the pneumatic apparatus should be applied in the same manner in all respects as in cases of pleuritic effusion in which the pleural cavity has not been opened.

Later on, when the exudation has been completely absorbed and there is no longer any fear of irritation, and when there is dyspnoea or debility, when the patients are young or still in full vigour, and the thorax retains some elasticity and mobility, expirations into rarefied air may be combined with inspirations of condensed air, in order to restore more energetically than usually occurs by means of inspiration of compressed air the mobility and expansibility of the diseased side of the thorax, depressed by the retraction of the lung and the thoracic wall, as well as by the occurrence of more or less extensive adhesions between them. Inspirations of more strongly compressed air should at the close of the sitting succeed expirations into rarefied air, in order to restore the full distension of the pulmonary vessels and to restrain hyperæmic irritative conditions.

Waldenburg also recommended, in the case of youthful patients in whom pleuritic residua were still detectable after long-continued treatment with inspirations of compressed air, the combination of these with inspirations of rarefied air.

Schnitzler, as we have already mentioned, employs inspirations of compressed air in chronic adhesive pleuritis, where through adhesion of the pleural surfaces the breathing frequently becomes so painful that patients instinctively breathe quite superficially.

In purulent exudation into the pleural cavities mechanical treatment for the purpose of bringing about its absorption and a permanent distension of the lung tissue is counter-indicated. If, however, the empyema opens externally or an artificial opening in the thorax is made and the pus can thus be continuously discharged, inspiration of compressed air acts not only by the mechanical expansion of the lungs, whereby the pus is at the same time more easily evacuated, but it also reduces the secretion and suppuration, while here also, as with the above-mentioned exudations, a pressure from within is exercised upon the pleura and its vessels, and the two surfaces are pressed more firmly against one another.

Pneumatic treatment of course has no effect on the process which excites the suppuration. In Waldenburg's cases, who recommended mechanical treatment by inspiration of compressed air for emphysema specially, the result was permanently favourable, inasmuch as the pus was more completely evacuated, the lungs more dilated, and the dyspnoea lessened; but the suppuration was not arrested. Biedert treated an incised empyema in a boy nine years of age, four weeks after, while suppuration was still going on, but generally without fever, with inspiration of compressed air. At first, not to frighten the little patient, only a minimum pressure was employed, which was raised by degrees to  $\frac{1}{3}$  atmosphere in the ninth week; in the eleventh week close contact of the ribs was no longer observable, though no plug had been introduced for eight days, and a considerable space between the lung and the thoracic wall had almost disappeared.

Lastly, Geigel endeavours to account for the physical effect of inspirations of condensed air, so early manifested in considerable exudations, not only by the pressure which is exercised upon the exudation by means of the restored dilatatory and respiratory power in the lungs, as well as by the altered circulatory conditions, which favour absorption in

consequence of restored respiration, but he believes he has observed an actual secondary diuretic influence follow this treatment, which opinion has also been recently supported by Kelemen. But I am inclined to regard the increased secretion of urine as the result rather than the cause of the absorption of these exudations.

The method to be followed in the treatment of the several pleuritic exudations has already been laid down, from which general rules can readily be deduced.

Mechanical treatment ought to be commenced towards the third or fourth week, or as soon as the fever permits.

If we would attain the most favourable result possible, the compression pressure must from the first be high,  $\frac{1}{60}$  to  $\frac{1}{40}$  or  $\frac{1}{30}$  atmosphere, according to the irritability of the bronchial mucous membrane, and must be increased rapidly in long-continued and oft-repeated sittings as far as the general condition and the endurance of the patient allow.

In the employment of negative pressure in the form of expirations into or inspirations of rarefied air, only low degrees of pressure should be used and all necessary precautions observed, and each application must be followed by 60 to 80 inspirations of compressed air.

After a few weeks of this treatment the pleural exudations and fibrinous deposits and false membranes may disappear, as well as the compressed condition of the lungs and the resulting thoracic deformities, so that in the majority of cases nothing is detectable even on physical examination.

In inspiration of compressed air in all cases of pleuritic affection and their sequelæ, the patient is recommended (Cube) to adopt the lateral position on the healthy side. In this way the air streaming in under a high pressure can on the one hand act more easily and fully on the affected lung and the side of the thorax and expand them; on the other hand the healthy lung, already predisposed to vicarious emphysema by the insufficiency of the diseased lung, will be in some measure protected from further inflation by inspirations of highly compressed air. It is also advisable, as a help in these processes, to place a firm, tightly stuffed cushion between the

bed or sofa and the healthy side of the thorax on which the patient lies (Cron).

The manual compression of the healthy side by an assistant during inspiration may aid the treatment still more.

### 7. *Diseases connected with Pulmonary Phthisis.*

#### (a) *The Phthisical Habit.*

The build of the thorax and the expansion of the lungs correspond accurately with one another, and are mutually dependent. It is by the form, size, mobility, and expansibility of the thorax that the space is determined within the limits of which the expansion of the lungs is accomplished and the deepest inspiration can be attained. Any contraction of the space within the thorax limits in a corresponding degree the expansion of the lungs and the respiratory capacity, and lays the foundation for the development of pathological processes. Conversely, we have seen on the other hand that the size and form of the thorax is also influenced by the inflation and non-retractibility of the lungs, so that in long-continued and progressive changes in the texture of the lungs the thorax increases in all its diameters as far as is possible, while the expansibility of its walls is proportionally diminished. This is the emphysematous thorax, the former the phthisico-paralytic thorax. In both cases the primary influence of the pathological changes of form is a mechanical one, upon which the other nutritional and functional disturbances are in the widest sense dependent; therefore both are equally accessible to mechanical influence and fit objects for pneumatic treatment. In the one case the retraction of the lungs and consequent narrowing of the thorax must be the object of treatment, as we have endeavoured to show in the preceding chapters; in the other we have to combat the opposite conditions.

Where the phthisical habit exists we must do all in our power to promote the re-modelling and widening of the thoracic space, as the form of the thorax is directly connected with the gradually developing respiratory insufficiency. In the long, narrow, shallow thorax, the sternal angle of which projects, while the epigastric angle becomes more pointed and

the supra- and infra-clavicular fossæ are depressed, the lungs, especially at their apices, will not expand in a manner corresponding to their normal function. The respiration becomes weak and superficial, the inspiratory as well as the expiratory pressure falls below the normal, and disproportionate shortness of breath follows any increased physical exertion on the part of the patient.

The application of altered atmospheric air pressure by the pneumatic apparatus is in the first place indicated in order to overcome the contraction of the thorax which has been produced by pathological conditions and to expand it as much as possible. As by inspirations of compressed air the intrapulmonary pressure of the pulmonary air is so far increased that it preponderates to a certain degree over the normal atmospheric pressure on the thorax, not only will an expansion of the lung tissue be thereby effected, but also—and that all the more the younger the individual we have to deal with—a widening of the thorax itself by elevation of the ribs and its expansible parts. The thoracic muscles are strengthened; the lung capacity, as shown by the pneumatometer, is often considerably increased; dyspnœa is removed; with increased respiratory surface and functional activity of the lungs sanguification is improved; there is increased appetite, a fresher appearance and subjective well-being, and under all circumstances, even if the outbreak of phthisis itself cannot in every case be arrested, a power of resistance to predisposing diseases is created in the lungs.

Lastly, in the phthisical habit, not only the mechanical action of altered air pressure on the respiration, but also its mechanical effect on the circulation, gives it a definite value. By expiration into rarefied air, as in the rarer air of high altitudes, the pulmonary blood-channel is widened, the anæmic condition of the lung tissue removed, the nutrition stimulated, the change of matter accelerated, and thus the danger is averted that, owing to the anæmic condition of the lung tissue, such as often occurs in the phthisical habit, the remaining products of inflammatory processes, infiltrations, and exudations may result in thickening of the tissue and caseous-degeneration.

With the steady application of positive and negative pres-

sure to the pulmonary surface, it soon becomes possible to demonstrate objectively the favourable effect of pneumatic treatment, and to express numerically the results obtained. Thus in faulty and insufficient apical respiration co-existing with hereditary predisposition, weakly constitution, and paralytic thorax the excursions of the chest, and especially of the upper parts of it, become visibly more extensive, the previously flat thorax becomes arched, its drawn and cramped position freer, and the apices of the lungs, which drew in air only sparingly, take in a fuller quantity with each inspiration (Geigel). But it is of special importance that the patient not only carries out this respiration, so different from what he has been accustomed to, for the first few months that he is subjected to the influence of altered pressure, but that he should also learn at once to breathe fully and deeply, and so to ventilate the apices of the lungs freely, by which means also the probability of dangerous bronchial irritations, excited by retained dust and secretions, is more and more reduced. We therefore observe as proximate and permanent results of the treatment, enlargement of the circumference of the chest, considerable, even doubled, elevation of the pneumatometric valves, increase of the vital capacity, improved nutrition, and a very remarkable increase of body weight. With these objective phenomena will be gradually combined the subjective ones of a feeling of well-being and increase of bodily strength.

The application of altered air-pressure to the lungs in the positive and negative sense will have to be accommodated to the pathological conditions of the lungs in persons of phthisical habit, and either the intermittent or alternate method of respiration must be carried out daily in one to two sittings with 100 to 200 respirations, according to the individual conditions. At the beginning of the treatment, when the simple cylinder apparatus are generally used, inspirations of compressed air are ordered, and later on an equal number of expirations into rarefied air, and the sitting is closed with a smaller number of inspirations of compressed air; with the double apparatus and the water-engine bellows we commence in the same way with inspirations of compressed air, and later on pass to the alternate application of condensed and rarefied air. As in this method



inspirations of compressed and expirations into rarefied air are directly combined with one another, therefore here, in contrast to the intermittent method, the simple number of respirations suffices to obtain the desired therapeutic effect. The compression and rarefaction of air must not be high; we begin with a low  $\pm$  pressure of  $\frac{1}{10}$  atmosphere and rise to  $\frac{1}{5}$  atmosphere: with the water-engine bellows we begin, using equally high tensions for condensed and rarefied air, with  $\pm 6$  centimetres, after a few respirations rise to  $\pm 10$  to  $\pm 20$  centimetres, and lastly up to 30 centimetres of the water manometer, and after this difference has acted upon the patient for 80 to 100 respirations it is gradually lowered in the course of 40 to 60 further respirations, and slowly passes to the normal atmospheric pressure.

Pneumatic treatment must extend over weeks and months, and must be renewed a few times every year. Lastly, Waldenburg recommended, for the purpose of securing a more energetic action upon the specially ill-developed apices of the lungs, that during the sittings the lower parts of the chest should be compressed with strapping.

The indications for pneumatic treatment in diseases connected with pulmonary phthisis are determined by the nature, the intensity, and the diffusion of the disease of the tissues, and its effect will rarely be radical, generally only symptomatic and palliative, according to the seriousness of the affection and the complete inaccessibility of the processes to therapeutic procedure. It is only where sufficient expansion of the lungs and compression of hyperæmic mucous membranes and portions of lung can be effected, and chronic inflammatory processes thus subdued, that the increased pressure on the lungs from inspiration of compressed air will have a radical effect. In almost all other cases we must be content with a partial improvement, by increasing the supply of oxygen, by free ventilation of the lungs, by compression of hyperæmic portions of the tissue, and diverting the blood accumulation, or by widening the pulmonary blood-channels and increasing the flow of blood, partly anti-phlogistically, partly as a stimulant, or antidyspnœically, according to the grouping of the symptoms prevailing at that stage of the malady.

As, however, a series of other phenomena in the multiform phthisical processes demand therapeutic interference, such as disturbances of nutrition, intercurrent fever, irritative conditions of central origin, local inflammatory processes in the upper air passages, putrefactive processes in the bronchi and cavities, lobular and lobar acute and chronic pneumoniæ, &c., pneumatic treatment in such cases can only act as a palliative in combination with other dietetic and medicinal remedies and with the application of locally acting pharmacological substances (v. 'Chemical Part') in the diseases connected with pulmonary phthisis.

(b) *Catarrh of the Apex.*

Owing to its twofold action, expansive and antiphlogistic, the application of compressed air produces the most decided results in subacute and chronic catarrhs of the bronchioles of the apices of the lungs. This is the first affection of a long series of pathological processes, with which pulmonary phthisis begins its destructive work, and consequently the affected organ and the general strength of the patient is here most capable of energetic reaction. The action of inspirations of compressed air will be most favourable in those cases in which nothing can yet be detected in the lungs by percussion, and auscultation only reveals the symptoms of a slight chronic pulmonary catarrh, viz. fine crepitant râles at the apices of the lungs. The symptoms of apex catarrh almost always occur in individuals of the phthisical habit, and they are aggravated by the respiratory insufficiency resulting from the build of the thorax. As yet the cough and expectoration may be slight; the general health may, however, though not always, be subject to more or less grave disturbances, and the nutrition and strength gradually, though not perhaps constantly, on the decline. But even in cases where the malady has gone beyond this stage of catarrhal affection of the apices of the lungs, and the process leading to atrophy of the tissue is already far advanced, so that the dull, sometimes tympanitic note and the altered respiratory sound already indicate a diminution of air capacity and infiltration in the apices of the lungs, even under such conditions, as I have recently convinced myself repeatedly, satisfactory results are obtained by inspirations of compressed air, or still more by

inspiration of compressed and expiration into rarefied air. The immediate result of mechanical treatment in such cases is the relief of dyspnoea, of the irritative cough, and above all of the expectoration, results arising out of the simple mechanical antiphlogistic action of raised pressure on catarrhal, hyperæmic, and swollen tissues. At the same time the general condition of the patient improves visibly with the retrogression of the local affection. Nutrition is ameliorated, body weight and strength increased; the patient looks healthier, and his subjective wellbeing is promoted by the changes of his previous habit.

Finally, under the prolonged influence of compressed air the general assemblage of physical symptoms undergo a favourable change; even in cases of unmistakable apex catarrh the crepitant râles gradually disappear, the air penetrates freely into the diseased portions of the lungs, the dull percussion note decreases gradually in intensity and extent; and so far as one can judge, in a latent and almost incurable disease, the whole process seems, at least, to be arrested (Geigel).

(c) *Peribronchitis and Chronic Inflammatory Infiltrations of the Lung.*

Another object accessible to the mechanical influence of increased air pressure is peribronchitis and chronic inflammatory infiltration, if these processes have not yet led to any considerable disorganisation of the lung tissue.

The therapeutic effect of pneumatic treatment in this case also depends upon the compression which the inflamed, hyperæmically swollen and infiltrated tissue undergoes from the increased intrapulmonary air pressure after inspirations of compressed air. The blood is forced out of the inflammatorily excited and engorged capillaries; the arterial influx is checked and the venous efflux accelerated. In like manner transudation from the blood-vessels is arrested, the fluid of the tissues forced from the interstices of the tissues into the lymphatics, and the removal of useless and waste material promoted. Through the flowing in of condensed air into the bronchi, narrowed by tumefaction of the mucous membrane, or obstructed by mucus, and by the removal of these impediments as well as by the general pressure on the alveolar walls and septa thickened by infiltra-

tion, the air cells, where they have become more or less reduced in volume, either by being less filled with air, owing to partial obstruction of the bronchial ramifications, or by thickened lung tissue, become again expanded, and as far as possible restored to respiratory activity.

In this way slighter losses of resonance, which clearly indicate more or less circumscribed infiltrations of the lung tissue, may gradually disappear under the influence of increased air pressure, so that the previously affected spots can no longer be detected by percussion, while the râles of the accompanying catarrh either completely disappear or occupy a diminished area if the disease has already reached a great intensity.

The fever accompanying the local affection is always of importance; if it is absent or only moderately high, or if the exacerbations are only of short duration, the result of pneumatic treatment is accordingly more rapid and complete; but high fever even without important exacerbations interferes with all mechanical effort directed upon the diseased lung tissue, or in the majority of cases neutralises it altogether.

(d) *Desquamative Pneumonia and Broncho-pneumonic Ulceration.*

Pneumatic treatment has little or rather no effect in violent inflammatory infiltration of the lung tissue resulting from diffused peribronchitis, chronic broncho-pneumonia, and desquamative pneumonia.

The inflammatory pathological process, as also the infiltration deposited by it in the lung tissue and the air cells, are not to be repressed by the pressure of instreaming air. Rather there is danger, owing to the quantity of cellular elements deposited in the lung tissue, that, by the action of increased intrapulmonary pressure, the amount of blood contained in the lungs may, owing to the compression of their vessels, too easily suffer such a diminution that anæmic necrosis of the atelectatic or inflamed lung tissue, or caseous degeneration of the inflammatory products, may be directly induced by deficiency of blood in the lungs. Waldenburg therefore recommended, to compensate for the blood-emptying effect of compressed air, expirations into rarefied air, in order thus to obtain an increased flow to the pulmonary vessels and avert a threatening or already

partly existing anæmia of the tissue in cases in which there is no fear of rupture of the vessels and a secondary hæmoptysis by the artificially elicited flow of blood.

Geigel, while allowing the accuracy of the hypothesis that the danger of anæmia of the lung parenchyma is incurred when the circulation of the nutrient blood is lessened or checked in the nutrient vessels by the pressure of occluded bronchi and spots of parenchymatous thickening, by insufficient apex respiration and asystole of the left ventricle, still defends, in opposition to Waldenburg's observations, the action of inspiration of compressed air on the nutrient vessels of the lungs, the *vasa privativa*, by means of which the bronchial arteries belonging to the greater circulation provide the nutrient blood of the pulmonary parenchyma, and not the respiratory blood, and endeavours thus to furnish a proof that the inspiration of condensed air in incipient phthisis not only does not bring about the dreaded anæmic necrosis, but directly keeps it off.

It must, however, be observed, in opposition to this view of the conditions under discussion, that inspiration of compressed air does not increase the fulness and tension of the arterial vessels in the aortic system, as Waldenburg also maintained, but, as we have seen, diminishes them, and therefore the *vasa privativa* also contain less blood than in expiration into rarefied air, which is followed by an increased flow of blood into the arteries generally. Geigel's suggestion can only be taken into account when amounts of pressure are employed which limit the depletory effect to the superficially situated capillary system only of the respiratory blood, and all pressure is avoided which might at the same time produce greater anæmia of the lung tissue, and also in like degree compress the *vasa privativa*, although they issue directly from the aorta and belong to the systematic circulation. There can be no doubt that the pulmonary capillaries are more strongly distended and filled with blood by the rarefaction of air in the lungs during expiration into rarefied air than the *vasa privativa* by the transient increase of pressure in the aortic system during inspiration of compressed air, and thus the anæmia of the parenchyma of the lungs is more powerfully counteracted by expiration into rarefied air than by the increase of pressure after inspiration of

compressed air. But as in the reduction of air pressure in the lungs the vasa privata are less subjected to the aspiratory suction and to distension with blood than the capillary system of the pulmonary arteries, under considerable increase of pressure in the lesser circulation, therefore, as Waldenburg feared, there is certainly very great danger of vascular rupture and pulmonary hæmorrhage under this treatment, owing to vulnerability of the vascular walls and more or less destruction of the parenchyma of the lungs by pathological processes. Should such a hæmorrhage be actually induced by expiration into rarefied air—and there can hardly be a case in which its occurrence is not possible—the results of such an effusion of blood are far more injurious than the therapeutic effect contemplated by rarefaction of air. Expiration into rarefied air should therefore be employed very cautiously with phthisical subjects, under medical supervision if possible, or else avoided altogether, and the mechanical treatment of such lungs must be limited to inspiration of compressed air, the pressure action of which on the vessels has been frequently attended with advantage even in hæmoptysis. If the air for the expirations into the pneumatic apparatus is subjected to only a low pressure, from  $\frac{1}{60}$  to  $\frac{1}{30}$  atmosphere, such as has been proved to be appropriate by repeated experiments, and if we reckon in addition to the effect resulting from it upon the nutrient vessels of the lungs the full respiratory influence of the breathing of condensed air especially upon the apices of the lungs, we have—and now in agreement with Geigel—found a method of treatment with which we may vigorously and generally combat incipient and advancing phthisis.

If the destructive process in the lungs has already made great inroads, if it has led to disintegration of tissue and formation of cavities, while an extensive tract has through infiltration become lost to the respiratory process, if respiration is thereby quickened, exchange of gases incomplete, and ever-increasing craving for air present, in such cases no permanent success can be obtained from pneumatic any more than from any other treatment; but a palliative one, highly beneficial to the patient, may be introduced by application of altered pressure of air to the more or less respiratorily insufficient lungs. An

extraordinary relief is brought to the patient by the introduction of air, rich in oxygen and removal of the exhausted expiratory and stagnant residual air by means of inspirations of compressed air, or these alternated with expirations into rarefied air; general euphoria, cessation of the fits of coughing, and asthmatic and dyspnoëic troubles, decrease of expectoration, increase of appetite, and not unfrequently improvement of nutrition are in many cases the immediate results of a rational use of this method. The subjective relief and subjective well-being produced by accelerated pulmonary ventilation, by improvement of appetite and of nutrition, will of course be all the more marked in those cases in which the disease itself comes under treatment in the more favourable stages, and broncho-pneumonic, infectious forms, scrofulous pneumonias, formation of cavities, and other destructive processes are not yet advanced. It will therefore be wise, wherever circumstances permit, to afford this palliative aid to patients by employing a mode of treatment in which they eventually place full confidence, obtaining from it a relief never before experienced.

Lastly, the influence of pneumatic treatment is decidedly beneficial to the healthy portions of the lungs, in which the pressure action represses as long as possible inflammatory affections with exudation and infiltration, brings about a better development and expansion of their tissue, strengthens their elasticity, facilitates their functions where there is great debility, and energetically promotes the exchange of gases.

#### (B) IN DISEASES OF THE HEART AND THE CIRCULATORY ORGANS.

The influence which the increase or decrease of intrapulmonary pressure exercises upon the amount of blood contained in the lungs affords indications for the application of these mechanical forces in diseases which are attended with disturbances in the circulation of the blood and which lead to hyperæmia or anæmia of the lesser circulation.

Pneumatic treatment of the lungs will exercise a favourable influence on these affections, if improvement is possible, and promote their removal by temporarily increasing or decreasing the flow of blood, or else retard the sequelæ which the prin-

incipal disturbances tend to set up until some other mode of compensation can be established. All affections of the heart and vascular system as well as of other organs which lead to great hyperæmia or anæmia of the lung tissue are included in this category. Waldenburg was the first to apply the pressure action of compressed and rarefied air on the heart to the special treatment of cardiac affections, but the employment of the pneumatic apparatus in these diseases did not find general acceptance. Notwithstanding the few cases published, we must certainly not cast aside the mechanical treatment of these maladies, but await further research before establishing its indications, which we cannot do now, owing to the paucity of practical experience and the conflicting observations as to the physiological effect of intrapulmonary pressure. What, however, we can do, even if we cannot radically influence the cardiac affection, is to correct the circulatory anomalies and to limit the grave symptoms arising in the various forms of heart disease, especially the group of respiratory disturbances, in which change of air pressure procures substantial relief.

(a) *Hypercæmia of the Pulmonary Circulation.*

In consequence of the increase of the pressure of the respiratory air in the lungs induced by inspiration of compressed air, the blood will be forced out of the pulmonary vessels in the manner already described and the lesser circulation disencumbered. According to Waldenburg this mechanical action on the pulmonary vessels leads to a temporary compensation of the disturbances in the circulatory apparatus, when it is necessary—

- a. To increase the systolic contractions of the heart and the pressure in the aortic system (?);
- b. To facilitate the outflow of blood from the heart, so as
- c. To retard the outflow of blood from the systemic veins into the right heart, and thus not only
- d. To diminish the quantity of blood in the lungs, but also
- e. To increase the amount of blood in the systemic circulation (?).

These are the indications following from Waldenburg's deductions as to the action of compressed air, to which we can only partially commit ourselves, and we should consider whether



these disturbances may not be better compensated by expiration into rarefied air, in which the blood pressure and the tension of the arterial walls are increased, not for a short time only, as in inspiration of compressed air, but during the whole course of expiration, while engorgement of the systemic veins is removed and the action of the heart materially aided by facilitating its diastole.

1. *In Mitral Insufficiency and Stenosis.*

Compressed air exerts no influence upon existing valvular insufficiency, as is self-evident, and its employment will therefore be useless in cases where complete compensation has developed, or it will only be useful for supporting mechanical treatment so far as is possible by the conditions of equilibrium obtained by compensation in the pulmonary circulation, and of antagonising any temporary deficiency in the same. On the other hand, the forcing back of the mass of blood engorged in the lungs by the pressure of condensed air ought to be attended with good results in those cases where only incomplete compensation, or none whatever, has taken place, and hasten the advance of a compensatory hypertrophy of the heart, and reduce the excessive labour imposed on the enfeebled cardiac muscle by moderating for some hours daily the stronger pressure exerted upon it, and so improving its nutritive conditions. We should thus obtain not only a transitory effect, but the result of the treatment would be permanent and determinable subjectively and objectively. The compensatory action of the inspiration of compressed air ought to be obvious even after a few sittings, often after the first, by cessation of palpitation of the heart, by improvement of the small, intermittent pulse, and by disappearance of dyspnoea and cyanosis. The immediate effect on the circulatory apparatus, as well as its behaviour during the course of the treatment and the progressive improvement, has been sphygmographically illustrated by Hänisch, who has given an accurate exposition of these conditions in the following case.

The patient from whom Hänisch took the following tracings for his demonstration, R. Sch., was a girl of seventeen years of age, who during the inundation of November 13, 1872,

had been obliged to remain a long time in her wet clothes. The consequence was an acute articular rheumatism, in the course of which endocarditis was developed, which led to insufficiency and stenosis of the mitral valve.

When the patient came under his treatment a considerable disturbance of compensation existed, as manifested by marked cyanosis, diffuse bronchial catarrh with tempoary sanguineous expectoration, considerable shortness of breath, and a small, irregular pulse. There was undoubted engorgement of the pulmonary circulation and of the systemic veins, and the systemic arteries were imperfectly filled.

Since by inspirations of compressed air, as Waldenburg assumed, in the first phase of pressure action, the pressure in the aortic system is raised and the flow of blood into it increased, while in the pulmonary circulation, on the other hand, it is diminished, Hänisch saw that this case was adapted for sustained treatment by means of inspirations of compressed air. If this was successful not only must the pulse become for the time tense and full—evidence of which would be given by the tracings—but the quantity of urine must be increased and the vascular engorgement in the lesser circulation, if not altogether removed, at least reduced.

The treatment was carried out in the following manner for three weeks: the patient inspired daily three cylinderfuls of



FIG. 70.

compressed air, at first with a compression of  $\frac{1}{3\frac{1}{2}}$  atmosphere, gradually rising to  $\frac{1}{4\frac{1}{7}}$  atmosphere pressure and higher. Curve fig. 70 was traced immediately before the first inspiration on

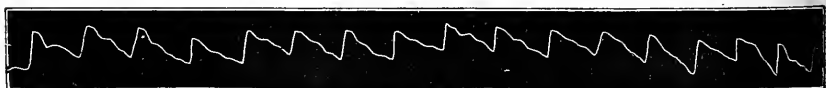

FIG. 71.

January 31, 1874, curve fig. 71 ten minutes after the patient had completed the inspirations of the first day, and we find

distinctly marked in the latter the greater systolic elevation and the slighter prominence of the dirotic wave. Curves *a* and *b*, fig. 72, were traced on February 14, the first before and the second after the inspiration. We see by comparing these with the former curves that considerable improvement has been already effected, for the curve *a* is not only higher than the curve in fig. 70, but equals in height the curve in fig. 71. In

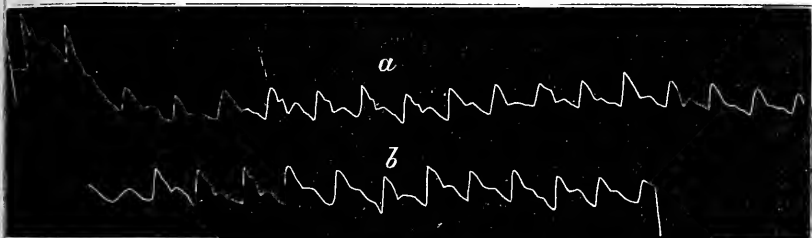

FIG. 72.

curve *b* the direct influence of compressed air again stands out clearly as compared with curve *a*, fig. 72; these two curves may be regarded as pretty nearly normal.

That this result, however, is not merely accidental and transitory is shown by curves *c* and *d*, fig. 73, also traced before and after inspiration at the end of the third week of

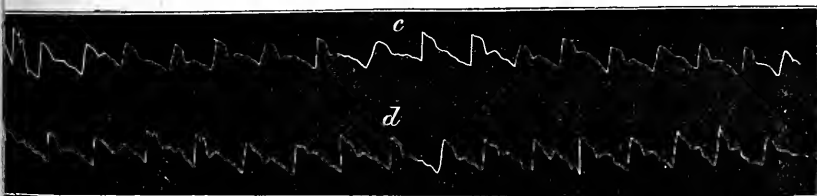

FIG. 73.

treatment, February 21, 1874. Precisely the same relations are found in them as in the previously traced curves *a* and *b*, fig. 72.

Hänisch observed the same steadily advancing improvement in the other phenomena of disturbed compensation during treatment. The quantity of urine became normal, the respiratory troubles were removed, and the condition of strength visibly improved.

Schnitzler observed the disappearance of a systolic murmur

and the restoration of the normal tone under the influence of compressed air. The case was that of a schoolmaster, R. K., 30 years of age, who had suffered for a long time from palpitation of the heart and difficulty of breathing. Schnitzler detected insufficiency (not very advanced) and stenosis of the mitral valve with corresponding compensatory hypertrophy. Inspirations of condensed air were ordered. With remarkable rapidity the inspirations caused the small, irregular pulse to become larger and regular; but what was far more surprising, the systolic murmur previously heard had disappeared, and in its place a tolerably clear tone was audible, which became stronger and stronger the longer Schnitzler caused the patient to inspire condensed air. The fact was attested by several physicians, many of whom were experienced practitioners and skilled in diagnosis. Schnitzler does not attempt to explain the phenomenon.

It is clear that together with the cases running a favourable course there will be a series of less favourable ones, and some in which mechanical treatment of the existing circulatory disturbances will lead to no result; but such occurrences are not confined to these specially difficult cases, but are common to other maladies which are more readily accessible to medical treatment. The more or less favourable result of inspirations of compressed air also depends on many conditions difficult of control, such as the general strength of the patient, the presence or absence of secondary disturbances, &c.; if the strength has fallen low and consecutive conditions are present, such as albuminuria, Bright's disease, œdema, &c., there is the hope of a successful result.

Similar pulmonary hyperæmia is also caused by

## 2. *Insufficiency and Stenosis of the Aortic Valves,*

in which the raising of intrapulmonary pressure is said to disencumber the pulmonary blood channel in the same manner, and thus to act in the same compensatory sense as in the preceding cardiac affection. In this case also our information is very scanty; Waldenburg records only favourable results. Biedert mentions two cases of insufficiency and stenosis of the

aorta, in which, by inspiration of compressed air, he only succeeded in affording temporary relief to the catarrh and dyspnoea, but not in retarding the rapidly advancing fatal end.

In cases of insufficiency of the aortic valves with excessive activity of the hypertrophied left ventricle, Fenoglio maintains that expiration into rarefied air is indicated, instead of the usual inspirations of compressed air.

According to Fenoglio, the object of pneumatic treatment is not to antagonise the circulatory disturbances, such as engorgement in the lesser and greater circulation and the phenomena dependent on them, as they would be overcome by the unusually rapidly occurring compensatory hypertrophy of the left ventricle, but to lessen the excessive compensatory activity of the ventricle, to which, and not to the insufficiency as such, he attributes the subsequent troubles. He is of opinion that the slight results obtained by inspirations of compressed air are simply due to their mechanical action, by which the force of the cardiac muscle is stimulated, whereas expirations into rarefied air retard its contractions and lower its activity (?).

In this deduction, however, we must keep in view the whole action of rarefied air on the heart and circulation, and especially the removal of venous engorgements in the systemic circulation, of the passive hyperæmia of the lungs, which gives place to an active one, whereby more blood is conveyed to the arteries and the dilatation of the heart is facilitated. This being the case, it must appear questionable how far the results in Fenoglio's cases are to be attributed to this or to the action of the expiration into rarefied air which he employed.

Fenoglio caused three patients who suffered from insufficiency of the aortic valves, with excessive activity of the much enlarged left ventricle, to expire into rarefied air, during which sphygmographic tracings of the pulse were taken. Before expiration into rarefied air the pulse wave rose abruptly to an excessive height, proportional to the vigorous contraction of the cardiac muscle, and fell as abruptly, with well-defined dicrotic wave. So soon as the action of the rarefied air began, signs of diminished tension and fulness of the arteries are said to have appeared. After the close of the expiration the height of the wave remained steadily diminished; the line of descent was

less abrupt and showed a marked decrease of diastole. In the early days of treatment, which was limited to one sitting daily, the effect on the pulse did not last till the next application of diminished air-pressure. But as the treatment was continued the effect became more and more lasting, and a decided and progressive improvement in the general health of the patient took place immediately. The palpitations of the heart, the subjectively tangible pulsation of the arteries diminished; the feeling of anxiety and oppression, the constriction of the thorax were no longer present. At the end of the treatment, after 15 to 25 daily sittings, the changes in the pulse curve remained constant, and also the improvement in the general condition of the patient was maintained. In one of the three cases the result of the treatment was completely maintained even after a month had elapsed. Of course, considering the nature of the affection which lies at the root of the disturbances and gives no prospect of permanent improvement, a renewal of the pneumatic treatment will always become necessary in a longer or shorter time.

As regards the other changes of air pressure employed by Fenoglio, inspirations of rarefied air proved to be inapplicable, as they soon exhausted the strength of the patients by the efforts they demanded. Inspirations of compressed air were not attended with favourable results, except in those cases of insufficiency of the aortic valves in which either sufficient compensation had not yet been set up, or it had become insufficient or had even ceased altogether, in consequence of the degeneration of the cardiac muscle.

Waldenburg treated a few cases of

### 3. *Fatty Heart,*

with temporary good effects; in others pneumatic treatment exercised no influence upon the existing circulatory disturbance.

### 4. *In Passive Hyperæmia of the Lungs from Cardiac Affections, leading to Chronic Hæmoptysis,*

the employment of compressed air is theoretically indicated, and Waldenburg defended it, even though the results which he obtained in these hæmorrhages by means of inspirations of

condensed air were anything but satisfactory. The irritative effect connected with these inspirations, owing to the changes of vascular fulness during the inspiration and expiration, and the accompanying fluctuations of pressure within them, will in most cases form an almost invincible obstacle, and always lead to fresh hæmorrhages in the vulnerable parts.

Lastly,

5. *Pulmonary Engorgement induced by Secondary Fluxions*

will, in a series of maladies, which in other organs lead to hyperæmia and hæmorrhage, produce as the first result inflammatory conditions and vicarious hæmorrhages which indicate mechanical treatment. Such are disturbances in menstruation and suppressed hæmorrhoidal flux. Sommerbrodt reports the successful treatment of bronchitis of two years' standing with monthly recurrence of fits of suffocation as a form of vicarious menstruation. In this case not only was the pulmonary circulation relieved, so as to free the lungs from the bronchitis, but also the systematically prolonged increased fulness of the systemic circulation by engorgement was made use of to guide the regularly occurring blood congestion of the female organism into its natural path. Waldenburg also employed compressed air in chlorosis, after having himself witnessed good results in chlorotic subjects during the pneumatic treatment of other diseases with reference to circulatory conditions. It is, again, the weakness of the cardiac muscle in chlorosis which does not allow the blood to flow in the natural way into the vessels, possibly too constricted in chlorotic subjects, which seems to him to afford an indication for the employment of inspirations of condensed air. The consequent increase of intrapulmonary pressure seems then to facilitate heart action compensatorily, and to relieve the pulmonary circulation.

(b) *Insufficient Fulness of the Pulmonary Circulation.*

In opposition to the preceding circulatory anomalies there occurs, as a result of diseases of other organs, defective filling of the pulmonary vessels and engorgements in the systemic circulation, with secondary changes of the parts thereby affected.

An increase of the blood contained in the lungs and intra-

thoracic organs ought in such cases, according to Waldenburg's theory, first to lower the pressure in the aortic system, then to facilitate and increase the efflux of blood from the systemic veins to the heart, and lastly lower and impede the afflux to the systemic arteries.

The desired mechanical effect will be obtained either by expirations into rarefied air or by inspirations of rarefied air with reduction of the pressure on the pulmonary surface and suction of blood towards the pulmonary vessels. Waldenburg in such cases recommends only inspirations of rarefied air and not expirations, because, from regard to the lungs, they could not be carried out with so high a pressure as to be capable of exercising the desired mechanical influence on the heart and circulation. Inspirations of rarefied air act much more powerfully with low pressure than expirations into rarefied air with high pressure, but they presuppose a considerable amount of strength and little dyspnoea if rarefied air is to be actually sucked into the lungs and not merely a rarefaction of the air already present in the lungs effected by impeded respiration or converted by the increased negative pressure against the will of the patient into an expiration, by the aspiratory suction of the apparatus overcoming the suction of the lungs in inspiration. Schnitzler therefore prefers in these affections to employ expiration into rarefied air and not inspiration.

Theoretically it is affections of the right side of the heart which should be most accessible to treatment with inspirations of rarefied air and expirations into it, because in them abnormally diminished fulness of the pulmonary circulation occurs, which might be removed by the suction action of the rarefied air. Further estimation of the value of this method must be left to the future, as practical observations are entirely wanting; whether a favourable result is to be obtained from inspirations of compressed air to be used alternately with inspirations of rarefied air, also recommended by Waldenburg, cannot as yet be settled even theoretically.

Schnitzler has treated a case of insufficiency of the tricuspid valve with stenosis of the ostium venosum dextrum. There was no doubt as to the accuracy of the diagnosis, notwithstanding the rare occurrence of this malady. There was a



dulness extending from the second to the sixth rib and 1 to 2 centimetres beyond the right sternal margin, corresponding with the excessive dilatation of the right side of the heart; the transmitted systolic and diastolic murmur had blended into one, audible directly over the sternum at the fifth sterno-costal articulation, and differed essentially from the murmur also heard over the left ventricle, which was due to a concomitant insufficiency of the mitral valve and stenosis of the ostium venosum sinistrum; lastly, the sharp accentuation of the second pulmonary sound, and above all the strong pulsation of the jugular vein, spoke in favour of the diagnosis, which was also otherwise confirmed. The most distressing symptom was aggravated dyspnoea, and this induced Schnitzler to try expirations into rarefied air. For a few days it almost appeared as if the small and irregular pulse became larger and more regular. Once, however, during the respiratory treatment the patient was seized with so violent an attack of suffocation (to which he had been liable for years) that Schnitzler desisted from the pneumatic treatment, though the patient begged for it. The patient soon after succumbed to his grave diseases.

The degrees of pressure employed by Waldenburg in heart diseases stand between  $\frac{1}{30}$  and  $\frac{1}{50}$  positive and negative atmosphere pressure. We have no further reliable records.

---

## ALTERATIONS OF AIR PRESSURE ON THE PULMONARY SURFACE PRODUCED WITHOUT APPARATUS.

### 1. *Deepened and Prolonged Inspirations.*

The simplest kind of mechanical influence which can be brought to bear on the lungs and heart in breathing is that produced by deep, long-drawn inspirations. The influence of this purely physiological procedure, always readily available, is not to be despised. Deep inspirations methodically pursued have long been recommended, especially in phthisis, and their employment by Dührssen has brought them again into vogue.

Inspiratory dilatation of the thorax may affect either the superior region specially, viz. the infraclavicular region, or the

antero-lateral regions or the inferior region (abdominal breathing), according to the particular group of inspiratory muscles called into action.

With the increase of capacity of these different zones the corresponding portions of lung especially undergo an inspiratory expansion—e.g. in superior thoracic breathing the apices of the lungs, in lateral breathing the lateral and anterior parts of the lower, middle, and a part of the upper lobe of the lung, and in abdominal breathing, which considerably increases the capacity of the thorax in its longitudinal diameter, the whole vertical extent of the lung from apex to base.

A greater expenditure of strength is required in the two first methods of respiration, i.e. the dilatation of the part of the thorax enclosed by the ribs when carried out independently, than in the latter, which increases the space downwards and outwards by the contraction of the diaphragm and the displacement of the readily movable abdominal viscera, the abdominal muscles being relaxed. If, therefore, the deepened and prolonged inspirations are performed exclusively by superior thoracic breathing, with elevation of the ribs and expansion of the thorax in its antero-posterior and lateral diameter, as shown by the line *a db* in fig. 74, the patient becomes very soon tired, the expansions become more and more incomplete, and we do not get an uniform dilatation of the lung. The abdominal breathing, on the other hand, as shown in line *acb*, can be carried on more easily and uniformly, but it does not promote the expansion of the apices of the lungs and their anterior and lateral parts to the same extent as the superior thoracic and costal respiration. If we wish to obtain therapeutic results simply by deepened and prolonged inspirations, and to exercise thereby a considerable mechanical influence upon respiration and circulation, we must combine all three methods of respiration, and thus with the smallest expenditure of strength obtain the greatest possible expansion of the thorax and the lungs, as may be observed in the lines *a, d, c, b*. The most complete manner of carrying out these inspirations, which tend most to expand the thorax in all directions, with considerable economy of strength, is the following: Let the patient begin by expanding the infra-clavicular region as much as possible by vigorous elevation of

the upper ribs, then the lateral region, and end with abdominal breathing by means of strong contraction of the diaphragm. The negative pressure thus exercised on the pulmonary surface may rise from  $-1$  millimetre Hg in quiet respiration to  $-60$  up to  $-70$  and even  $-100$  millimetres Hg.

If after this act there is a feeling of complete expansion of the thorax and distension of the lungs with air, which cannot be carried further, we may then either hold the breath and keep the thorax expanded so long as possible without inconvenience,

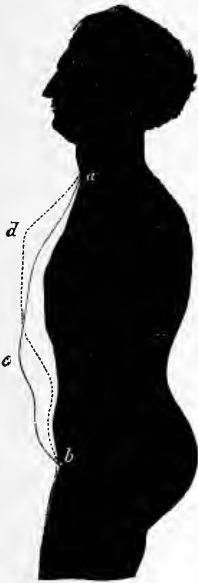

FIG. 74.

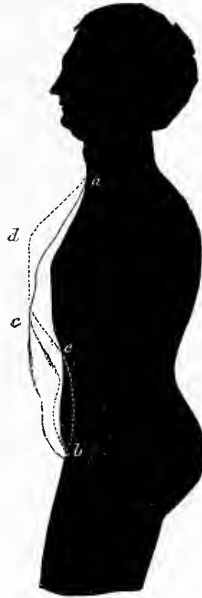

FIG. 75.

and then expire, or we may expire immediately at the end of inspiration.

Nor is it a matter of indifference how expiration is carried out, with what rapidity and from what parts of the lung the air is first driven. It is best to begin with abdominal expiration, as marked in fig. 75 by the lines *b, e, c*, and then allow the lower and upper ribs to collapse more or less rapidly, according as we desire to retain the air a longer or shorter time in the upper part of the lungs. When it is not desired to retain the air so long in the lungs, the ribs are allowed to collapse

at the same time as the diaphragm and the abdominal muscles are relaxed, and one vigorous expiration is made through the mouth.

In making the deep inspirations we should choose a convenient position unembarrassed by tight garments, either lying down or leaning back in a seat, or standing, in the latter case leaning somewhat forwards and resting on the arms. In this method the more slowly and deeply these inspirations are performed the more completely will the lung expand and the higher will be the rarefaction of the air in the air cells, and the greater the aspiration of blood out of the great venous trunks consequent on this rarefaction; therefore we shall secure an excess of blood in the pulmonary circulation, a more abundant supply of air, a freer exchange of gases, and better pulmonary ventilation. On the other hand the more rapidly such deep inspirations are performed the more imperfect will be the development of the consecutive phenomena, or their effect may even be nil, if the patient carries them out with only partial accuracy.

The effect of deep inspirations may be modified, strengthened, or weakened according as orifices of ingress for the inspired air are narrower or wider, and thus the rarefaction of air in the lungs resulting from the expansion of the thorax is more or less rapidly lost, and the action of negative pressure in the thoracic space is proportionally paralysed.

Negative pressure in the lungs is best and longest maintained when the air is inspired through one nostril only, i.e. through a comparatively small aperture of ingress; it is less so when inspiration is made through both nostrils, the mouth being closed—the common way—and least of all when the inspiration takes place with mouth and nose open. Here the external air, being under a higher pressure than the air in the lungs during inspiration, rapidly and abundantly fills the dilated air cells and equalises the inner and outer atmospheric pressure.

The therapeutic effect, therefore, of such inspirations methodically carried out is to obtain the greatest possible expansion of the pulmonary tissue as well as a copious supply of fresh air, rich in oxygen, by which the exchange of gases and pulmonary ventilation are vigorously promoted and the pulmonary capacity

enlarged. It also promotes the afflux of blood to the lungs and improves their nutrition, and lastly it increases the amount of blood in the aortic system and facilitates the cardiac systole. At the same time these inspiratory gymnastics tend to strengthen the thoracic muscles, especially the inspiratory ones, and to increase the elasticity of the thoracic walls.

Deep inspirations are indicated in all cases of illness in which their physiological effects are desired, therefore in insufficiency of the respiratory process, especially of inspiration, so far as it is independent of deeper lesions or of loss of elasticity and dilatation of the lung tissue; again, where a strong, full voice is required, or disturbance of speech, such as stuttering, is to be removed, where there is a narrow chest and general bodily weakness, but especially in the phthisical habit and in various stages of phthisis. In these pathological conditions very deep and prolonged inspirations cannot be too highly estimated. They will also be of advantage in bronchial catarrhs, to induce a freer and more copious expectoration. Owing to their influence upon the widening of the pulmonary blood vessels, as well as upon the circulation generally, they are useful in anæmia and disturbances of nutrition in the pulmonary tissue in general, and especially in the above-mentioned pathological conditions by increasing the afflux of blood to those parts, promoting the absorption of oxygen, and furthering sanguification and nutrition. Lastly, they are recommended in circulatory disturbances and affections of the right side of the heart.

On the other hand, to recommend deep inspirations in cases of pulmonary hæmorrhage shows a complete misunderstanding of the physiological processes during inspiration, as aspiration of blood towards the lungs is the result of the considerable increase of negative pressure in the thorax at the commencement of inspiration, and thus an aggravation of the hæmorrhage or a fresh vascular rupture may be induced.

As regards the application of deepened and prolonged inspirations, they must be carried out according to the nature and gravity of the malady, and according to the individuality and the condition of strength of the patient, many times in the day, say every two hours, or morning, midday, afternoon, and

evening—in short, as often as possible—for 5 to 10 or 30 minutes in fresh air, as free as possible from injurious admixtures, and continued for months. The sooner the patient becomes tired the shorter must be the exercises, but they must be renewed all the sooner; as strength increases they may be lengthened, without diminishing the number.

The drawback to this treatment lies first in the impossibility of estimating the pressure coming into action and so fixing precisely the amount of mechanical force necessary for the special case, and secondly in the want of intelligence and perseverance in many patients. This defect, however, is partly compensated by the simplicity and cheapness of the method, carried out without preparation or apparatus, as well as by the long duration of its influence. I have not hitherto found cause to complain of defective or unsuitable use of the method on the part of patients, if the method is taken in hand seriously and the directions are precise.

## 2. *Prolonged Expirations.*

Opposed to deep-drawn, long-sustained inspirations are long-continued expirations against a positive expiratory pressure produced by phonatory (*phonatorisch*) contraction of the glottis.

These expirations are not carried out by themselves, but in combination with phonatory actions of the larynx, as crying, singing, speaking, &c. The effect of the method depends on an elevation and prolongation of the intrapulmonary pressure increased by a strengthened expiration, and therefore approaches that of inspiration of compressed air or expiration into it, or the effect of Valsalva's experiment. While the inspiration either proceeds in the ordinary way without increase of the negative pressure from expansion of the thorax or is forcibly deepened, the positive expiratory pressure, usually amounting to only 2 to 3 millimetres Hg, rises to 80, 100, and even 120 millimetres Hg.

The phenomena produced by this mode of respiration are, in the first place, a stimulation of respiration generally; more oxygen is absorbed and more carbonic acid excreted than in ordinary respiration; the ventilation of the lungs is increased, the lungs and thorax expanded, vital capacity augmented, and

expectoration promoted. But the influence extends especially to the circulatory apparatus. The pressure which the expiratory air compressed within the thorax for a long time exerts upon the alveolar walls impedes the circulation of blood in the pulmonary capillaries and retards the efflux of blood from the veins into the right auricle, so that, notwithstanding the more powerful contractions of the cardiac muscle, whose activity is even still more increased by the pressure, less and less blood is discharged into the arteries, and its chief mass accumulates in the systemic circulation and especially in the veins.

The earliest and simplest use of prolonged expiration is in the crying of an infant. We may regard crying as a natural, wholesome gymnastic act, founded on reflex movements (Rossbach). The forced and abnormally prolonged expirations, lasting in extreme cases up to thirty and thirty-five seconds, only interrupted by short inspirations, lasting often scarcely two seconds, are carried out with violently contracted rima glottidis, so that the air, finding itself under high pressure, forces its way out with loud, generally discordant screaming phenomena. In this process the influence of an increased intrathoracic pressure on respiration and circulation reaches an extraordinary height. When at last by screaming and the accompanying violent bodily movements the inconveniences which gave rise to them are removed, whether accumulation of mucus in the bronchi and consequent dyspnoea, or troublesome intestinal gases, fæces, and urine, the paroxysm ceases, but the child is not immediately quieted. There follows a series of deep and hurried inspirations and expirations, by which the changes produced in the circulation by the prolonged screaming expirations are, especially by strong aspiration of blood to the lungs, restored to equilibrium. It is not improbable that perhaps many of the later general conditions of ill health—*anæmia*, *chlorosis*, contracted chest, tuberculous habit—may be referred to the efforts of unintelligent mothers to stop their infants from screaming by soothing them to sleep in their arms or by stupefying rocking in the cradle (Rossbach).

Singing, like crying, has a remarkable influence on the respiration and circulation. The mechanical processes are the same as in those deep inspirations with increased expan-

sion and filling of the lungs, with a heightening of negative pressure and the flow of blood to the pulmonary surface following long-continued expirations during change of negative into high positive pressure, with its consequent effects on the respiration and circulation.

The healthy influence of singing on the general health, and especially on the lungs, has long been acknowledged, and almost all singing masters of any celebrity can tell of one case or another of consumption cured by their method of singing. Even though their diagnosis may not be very accurate in these cases, yet there is no denying that the influence which may be exercised by singing upon imperfectly developed lungs, narrow chest, anæmia, disturbances of nutrition in the lungs, and catarrhal conditions is a very important one and generally attended with good result. The singing mistress Marquise Ciccolini, who mentions a phthisical girl, who, by means of judicious singing exercises, not only acquired a very good voice, but was perfectly restored to health, herself recovered, by practising deep abdominal respiration and holding her breath, from an illness which her physicians called nervous asthma, and had afterwards repeated opportunity of completely curing similar cases in the course of her teaching, even in patients of advanced years.

Marquise Ciccolini recommends as the chief method to be applied in the art of singing, speaking, and reading deep abdominal respiration in which the inspirations are made through the nose. When the lungs are well filled with air, let the syllables *a, ba, ca, da* be pronounced aloud; then again, after a deep inspiration through the nose, *fe, ge, he, hi*, and so on; *ji, ki, li, mi, ni*, &c., taking special care to accentuate the consonants distinctly and to bring the syllables forward to the lips, so to speak. Let these exercises be practised first in the recumbent position, afterwards in the sitting, standing, even in bowed and bent positions, and soon the deep inspiration and expiration become a habit, and thus a quantity of air is supplied to the voice by which a strength and fulness is imparted to it previously unknown.

In consequence of the reports sent in from various quarters on the healthy influence of singing on the respiration and



circulation, and on the strengthening and nutrition of the lung, the practice of singing has been introduced even into prisons, in order to antagonise pulmonary consumption, which generally develops in a short time among the convicts. The method of singing devised by Fried. Grell is especially adapted for our national schools, and ought to be generally introduced, like gymnastics, from a sanitary point of view.<sup>1</sup>

The effect obtained by singing is also produced by sustained enunciation in public speaking, declamation, reading aloud; and P. Niemeyer mentions a phthisical subject who, probably having no capacity for singing, cultivated whistling as the most effectual form of respiratory exercises.

It is needless to say that exercises which more or less strain the larynx must be suspended when an affection of that organ is present or impending, and treatment by application of the pneumatic apparatus carried out.

### 3. *Valsalva's Experiment.*

It was quite natural that the idea should occur to the physician to turn to therapeutic use the pressure action exerted on the pulmonary surface in the experiments of Valsalva, Müller, and Weber, in the same manner as the homologous pressure action of the pneumatic apparatus.

Since in these experiments ingress or egress of air to or from the lungs is completely prevented after previous deep inspiration or expiration, there can of course be no question of a respiratory action of the lungs, but the pressure action coming into play here will especially influence the circulation; only a few deeper respirations are observed to follow the more active pulmonary ventilation. The result itself will naturally be entirely dependent on the greater or less docility and perseverance of the patient, who is generally left to himself during the carrying out of the treatment, while the amount of the positive or negative pressure coming into play remains quite undeterminable, and only the number of the experiments to be undertaken by the patient is somewhat under control.

Valsalva's experiment, as already mentioned, consists in

<sup>1</sup> Fried. Grell, *Theory of Singing for National and Middle-Class Schools*. Munich, Th. Ackermann, 1880.

making one vigorous expiratory effort with closed mouth and nose follow a more or less deep inspiration.

Weber attempted to increase this pressure by exercising at the same time an external manual pressure on chest and abdomen. The effect of the experiment is therefore especially to increase the intrapulmonary pressure, which will generally, like expiration into compressed air, influence the pulmonary circulation and retain the blood in the veins of the systemic circulation. The amount of pressure brought into action may be estimated at about  $+\frac{1}{40} - \frac{1}{50}$  atmosphere. The influence exercised upon the arterial pulse is shown most clearly in the sphygmographic tracings given above (v. s.)

Valsalva's experiment may perhaps be utilised therapeutically in accordance with its physiological effects in affections in which compressed air is indicated on account of its influence on the circulation, therefore perhaps in stenosis and insufficiency of the mitral valve, and in these cases only when no pneumatic apparatus is at our disposal. Waldenburg has also made use of the high intrathoracic pressure attainable by this experiment in empyema with open thoracic fistula, to secure a more complete evacuation of the pus from the pleural sac. The experiment, however, is most frequently employed by aurists, as Waldenburg himself probably used it, to force air into the tympanic cavity in catarrh of the tube.

#### 4. *Müller's Experiment.*

In this experiment a deep inspiratory effort succeeds a more or less deep inspiration, with mouth and nose closed, whereby the negative pressure in the lungs is considerably raised, and a mechanical influence exercised on the heart and circulation analogous to the effect of inspiration of rarefied air. As Knoll and Schreiber have shown in their sphygmographic tracings, the blood pressure in the aortic system during the experiment, and that all the more the more complete the previous expiration.

Therapeutic use may be made of this method in cases in which the object is to induce aspiration of blood from the veins of the systemic circulation by lowering the intrathoracic

pressure, and also, according to Waldenburg, in affections of the right side of the heart. Here also the action of the method is that of simple pressure action, limited to the heart and circulation, while the respiratory influence obtained by rarefied air in the pneumatic apparatus must be excluded, owing to hindrance of the exchange of air in the lungs.

Nevertheless both the physiological experiments of Valsalva and Müller, when applied to therapeutic purposes, by no means attain the efficiency of the pneumatic apparatus, nor can they serve as substitutes for it. Their influence is extremely limited, and still further diminished by the fact that their mechanical efficiency is for the greater part entirely withdrawn from medical control. Besides, patients, when left to themselves, are seldom so conscientious and persevering as to carry out such experiments accurately according to prescription. Therefore even in cases in which the one or the other method may promise success, if a pneumatic apparatus is to be had, it will always be safest to employ it for pneumatic treatment, without wasting the time and patience of the invalids with these experiments.

##### *5. Involuntary Respiratory Exercises in Walking and Climbing.*

More vigorous respirations are induced by walking and climbing moderate heights by paths not too steep than by remaining at rest, and as these deep inspirations and expirations are no longer dependent on the will of the patient, but occur automatically and reflexly, they may be maintained at uniform strength for a long time, as long as the movement is continued.

The influences which we exercise upon the respiration in walking and climbing are the same which we effect by deep inspirations and expirations generally, only that the influence on the heart and circulation is strengthened by the increased bodily movement; this is all the greater the more the respiration has been impeded by circulatory disturbances, therefore in diseases of the heart, fatty heart, weakness of the cardiac muscle, imperfectly compensated valvular defects, curvatures of the spine, scoliosis, cyphosis, and secondary affections of the

heart and the circulatory apparatus. I intend shortly to enter more fully into these conditions in a separate work.

In the maladies just mentioned unusually strong bodily movements, especially ascent of heights and mountain climbing, excite cardiac activity in a very extraordinary manner, even to violent palpitation, which on its side gives rise to invigoration of the cardiac muscle, and in combination with the expansion of the lung and its blood vessels to a more energetic repletion of the arteries, rise of pressure in the aortic system, and removal of engorgements. When such patients climb considerable heights or mountains, the respiration is at first short and rather superficial, and this and the rapid onset of violent cardiac action force them to stand still after a short climb. After a few respirations the rapid, superficial respirations are converted into extraordinarily energetic and deepened inspirations, accompanied with short, vigorous expirations which develop a respiratory and circulatory action, such as cannot possibly be obtained in any other way.<sup>1</sup>

If for one or other of the reasons given it is desirable to keep patients to mountain climbing, the respiration to be maintained during the ascent must be prescribed to them as follows: With one step they must perform an inspiration, with the next an expiration in even time, or distribute inspiration and expiration unequally over two or in case of specially short breathing one step, and pursue that till they are obliged to stand still, to bring into equilibrium the cardiac and vascular excitement, by deep respirations. When the respiration is again free, if the violent palpitations of the heart are quelled, the patient resumes the ascent till the same phenomena force him to rest again. The day following these laborious exertions the patient usually finds himself exceedingly well, the respiration freer, the disturbances in the circulatory apparatus less observable. By oft-repeated and gradually lengthened mountain climbing, at first perhaps up to 500 metres, later on up to 1,000 metres above

<sup>1</sup> I must express my entire dissent from these recommendations of Professor Oertel. I consider I have seen the gravest consequences result from persons with 'diseases of the heart, fatty heart, weakness of the cardiac muscle, imperfectly compensated valvular defects,' &c., attempting to walk themselves into condition. I should prefer to counsel them to restrict their exercise to level ground and to avoid all temptations to 'gymnastic' efforts.—TR.

the level of the valley, results may eventually be obtained in the respiratory and circulatory apparatus which would have been previously considered impossible.

With these strengthened methodical deep inspirations and expirations and the manner of carrying them out we have really overstepped the limit of our task, and approach chapters which must be referred to sanatory and especially respiratory gymnastics, the further demonstration of which would lead us too far from our goal.

## B. COMPULSORY AND INVOLUNTARY METHOD.

### BIBLIOGRAPHY.

Gerhardt: 'Treatment of Pulmonary Emphysema by Mechanical Promotion of Expiration,' *Berliner klin. Wochenschr.*, 1873, No. 3.—Ignaz Hauke: 'The Pneumatic Cuirass (*Panzer*),' *Vienna Med. Presse*, Nos. 34 and 36, 1874.—Id.: 'On a New Pneumatic Mode of Treatment,' *ibid.* Nos. 7 and 12, 1876.—Id.: 'Demonstration of a Pneumatic Apparatus,' *ibid.* No. 15, 1876.—*Stricker's med. Jahrbücher*, 1876 and 1877.—Id.: *New Pneumatic Apparatus and their Employment in Treatment of Children*. Vienna, 1876.—Id.: 'On Pneumatic Treatment of Children,' *Jahrbuch für Kinderheilkunde*, new series, vol. xiii. 1878.—v. Mosengeil: 'On Mechanical Treatment of the Sequelæ of Pleuropneumonia,' *Berl. klin. Wochenschrift*, No. 48, 1876.—Kaulich: *Prager med. Wochenschr.*, No. 2, 1880.—W. Brügelmann: *Inhalatory Treatment*, &c. Cologne and Leipzig, 1882, p. 111.

IN adopting a mechanical course of treatment in diseases of the respiratory and circulatory organs through alteration of air pressure acting upon the respiratory mucous membrane and the pulmonary surface, we assume that the patient shall co-operate in the application of increased or diminished air pressure by methodically regulating the various respiratory phases both for inspiration of compressed and expiration into rarefied air. When this is impossible by reason of the want of intelligence or education, or even resistance of the patient, it is useless to attempt pneumatic treatment by means of artificially altered air pressure acting only on the inner surface of the lung; yet, if it is necessary to exert a mechanical influence upon the lungs and the entire respiratory surface, the pressure or suction force

must be brought to bear from without and be quite independent of the dexterity and will of the patient. But even when these difficulties do not exist the mechanical influence may still with advantage be brought to bear from without, or must necessarily be so applied in order to obtain results which are not attainable by a local internal pressure, or where the mechanical effect of positive or negative pressure on the pulmonary surface has to be aided by an external pressure acting in the same or in an opposite direction.

It is especially in the case of children that the necessity for compulsory pneumatic treatment will occur, as it is impossible with them to employ apparatus which demand the voluntary co-operation of the patient in regulating the condensation and rarefaction of the air. Yet it is in childhood that the anatomical conditions for effective pneumatic treatment are found in an eminent degree, the thoracic walls being light, soft, and yielding, admitting of change of volume by the influence of external forces much more readily than the heavy, rigid thorax of adults, and in medical practice the mechanical promotion of respiratory movements is often urgently indicated, especially the inspiratory act, because, owing to the narrowness of the air passages in children and their feeble muscular power being soon exhausted, difficulty of breathing and respiratory insufficiency are apt to set in.

To carry out the pneumatic method under such circumstances we require apparatus which admit of the action of change of air pressure without the co-operation and even against the will of the patient. For such apparatus we have hitherto been indebted to Hauke, to whom we also owe our present method of pneumatic treatment by means of the transportable apparatus, and he has introduced them and used them with success in the Crown Prince Rudolph's Children's Hospital at Vienna, which is under his management. They are the so-called pneumatic '*Panzer*' (cuirass) and pneumatic '*Wanne*' (tub). Professor Kaulich, of Prague, has obtained favourable results with the pneumatic '*Wanne*.' The apparatus constructed by M. Woilliez in Paris for restoring asphyxiated persons to life, called *spirophore*, is identical in construction, application, and effect with Hauke's pneumatic '*Wanne*.'

The mechanical effect of these apparatus consists in shutting off hermetically the air immediately surrounding the thorax from the rest of the atmosphere and bringing about, by rarefaction of the air by  $\frac{1}{2.5}$  to  $\frac{1}{2.0}$  atmosphere, a difference between the air pressure within the lungs and that at the surface of the thorax, whereby the movable thoracic surface can be raised  $\frac{1}{2.5}$  to  $\frac{1}{2.0}$  kilogramme per square centimetre.

Waldenburg held the method to be capable of development in all directions, and considered that expiration might be facilitated by the employment of compressed air within the pneumatic 'Panzer' during expiration, analogous to expiration into rarefied air, and thus in emphysema the action might be akin to that of other mechanical pressure, but decidedly milder in its operation. And further, a combination of the raising of external air pressure by inspiration of compressed air might lead to a considerable disengorgement of blood in the lungs and the heart. From a technical point of view the establishment of a sufficient rarefaction of air in the 'Panzer' or 'Wanne' presents but little difficulty, because the atmospheric air pressure favours their being applied airtight. On the other hand, Hauke found it to be quite impossible, in rarefaction of the air within the 'Panzer,' to prevent the inflation of the material filling up the space between the 'Panzer' and the surface of the body and the escape of air. To compensate for this defect of the pneumatic method an attempt has, lastly, been made to effect an increase of the positive pressure on the outer surface of the thorax by confining the chest with bandages or having manual pressure of the thorax performed by a strong attendant instructed for the purpose, as suggested by Gerhardt.

## I. ACTION OF NEGATIVE PRESSURE ON THE THORACIC SURFACE.

### APPARATUS.

The apparatus devised by Hauke for carrying out compulsory pneumatic treatment accomplish (1) the occlusion of the air space immediately surrounding the thorax from the external atmosphere, in order thereby to aid the thoracic walls in their excursion outwards, and to expand the lungs naturally ;

(2) the rarefaction of the air within the above-mentioned occluded space.

(a) The former purpose is served in the case of small and patient children by the pneumatic 'Panzer,' with older children by the pneumatic 'Wanne.'

### 1. *The Pneumatic 'Panzer'*

is either a cylinder of reed matting or a semi-cylinder of strong zinc, large enough at least to enclose the body of the child in the recumbent position, including the upper extremities. The space between the margins of the 'Panzer' and the surface of the body is filled up with a flexible airtight material in the form of an indiarubber hood, provided with an aperture corresponding to the child's face and prolonged downwards like a skirt.

In using it the child, after the hood is put on, is placed in the recumbent position; the 'Panzer' is brought from below over the body of the child within the hood, the free lower skirt of which is drawn together under the feet of the child and closed with a broad piece of sticking-plaster. That part of the hood on which the child's back is placed is strengthened by a wadded pillow of tin or wood, which completes the rigid wrapping of the child's body. A double cock connects the 'Panzer' space on one hand with the outer atmosphere, on the other with a pneumatic apparatus which contains rarefied air. On turning the cock the ordinary air in the 'Panzer' is changed by rarefaction of the air. The change takes place the more rapidly the smaller the air space in the 'Panzer,' and herein lies the advantage of the latter over other more commodious contrivances.

Hauke has also constructed a second 'Panzer,' which is large enough to enclose the whole body of the child. This construction forms the transition to the

### 2. *Pneumatic 'Wanne,'*

which varies in form and size according as it is intended for larger or smaller children, and is adapted for lying or sitting (fig. 76). The orifice of the 'Wanne' can be closed by a lid,



which has been furnished with an aperture approximately corresponding to the child's neck. When the patient is placed in the 'Wanne' the orifice is closed by the lid and a hood drawn over the child's head, which, like that in the pneumatic 'Panzer,' has an aperture for the face, with elastic margin fitting the contour of the head, and the skirt of which is firmly pressed by means of an elastic strap to the sloping margin of the orifice of the 'Wanne.' A double cock inserted into the upper wall of the 'Wanne' connects it with the apparatus acting as aspirator, while a manometer shows the rarefaction of air in the 'Wanne' itself.

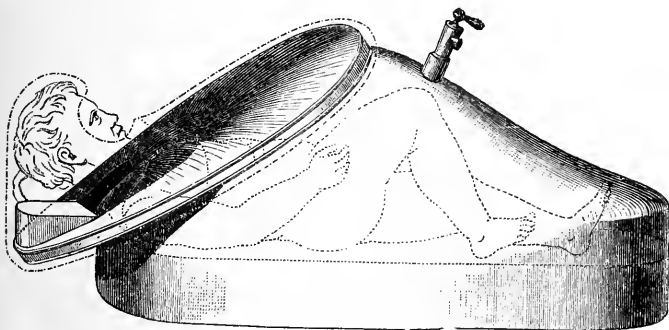

FIG. 76.

(b) The second object, the rarefaction of the air to be employed and the traction thereby exercised on the thoracic walls, is effected by a

#### *Pneumatic Apparatus.*

The apparatus which Hauke now employs by preference for the rarefaction of air in the pneumatic 'Panzer' and the pneumatic 'Wanne,' as also for direct inspiration of compressed and expiration into rarefied air, is constructed in the following manner:—

The apparatus, as the appended figure (fig. 77) shows, consists of receiver and bell, and stands upon a wooden floor from which rise three columns, which are united above in the form of a T. Through the longer of these cross pieces runs an iron rod, rising vertically from the centre of the bell cover, and supporting an iron transverse beam above the

framework. The two directly united columns are furnished at their upper end with an axletree with two fixed double pulleys, upon which four straps are wound. The two outer

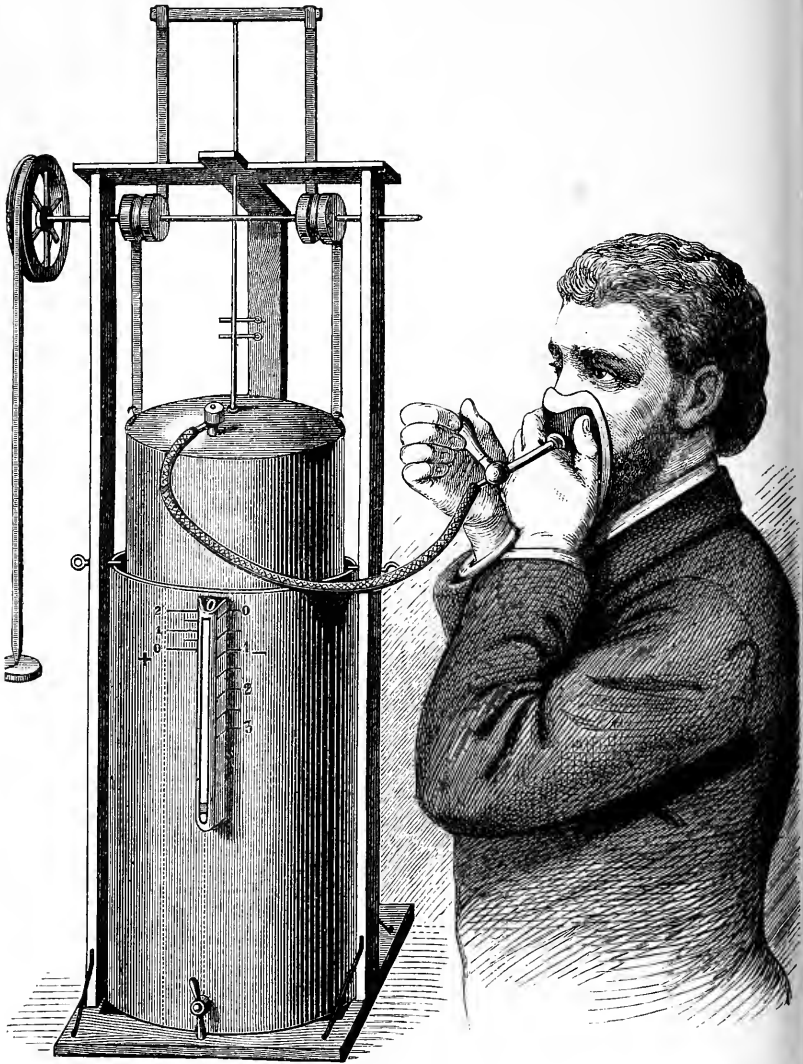

FIG. 77.

straps run vertically downwards to the bell, the two inner ones vertically upwards to the transverse beam on the rod of the

bell; the free ends of the straps are suspended on both sides in the corresponding ears of the bell and of the transverse beam. Besides this the axle bears outside the frame a large fixed pulley with a ballasting strap, which can be placed on the one or the other side of the pulley at pleasure.

The most important part of the mechanical construction is the axle with its fixed pulleys. When the axle is turned in the one direction the straps of the bell wind themselves up, while the straps of the beam unwind themselves; the bell is thus raised. When it is turned in the other direction the converse process occurs, and the bell is pressed down. If the receiver is filled with water, in the first case rarefaction, in the second condensation of air occurs in the bell, the degree being dependent on the force with which the axle is rotated. This force is supplied by the weighting of the great pulley, and as the axle must move in the direction of the traction, the weighting will create rarefaction or condensation of air, according as the strap is placed on one side or the other. The weights are so selected that each of them represents  $\frac{1}{200}$  of the atmospheric pressure on the surface of the cover of the bell, so that the weighting of the pulley with 2, 4, 6 weights creates a rarefaction or condensation of the air in the bell by  $\frac{1}{100}$ ,  $\frac{2}{100}$ ,  $\frac{3}{100}$  atmosphere, according as the weights are placed in the rarefying or condensing side. The degree of density of the air in the bell may be read off on the + and - scale attached to the water-level tube. From what has been said the action and the mode of employing the apparatus are clear. The following remarks apply to the use of rarefied air.

In the employment of rarefied air the weight of the bell must in the first place be balanced. This is done by weighting the great pulley with the balancing weight supplied; when one of the above-mentioned weights is added, the air becomes rarefied by  $\frac{1}{200}$  atmosphere, &c. When the bell has risen as high as it can, the loading weight has also reached the floor and must be drawn up again; this is effected by manual rotation of the great pulley; the labour of this can, however, be lessened where there is heavy loading by taking away a few weights. In winding up the apparatus the large aperture of the bell, by which it communicates with the atmosphere, must

be open, that the water may flow freely in and out; after it is drawn up this orifice must again be closed with the indiarubber stopper belonging to it.

The bolt pins in the central iron rod admit of the winding up of the apparatus to these points, in order that in high rarefaction of the air the lower margin of the bell may not get out of the surrounding water.

A flexible tube serves to connect the pneumatic apparatus with the 'pneumatic Wanne,' in which a double cock is inserted, to establish the alternating communication with the apparatus and the open air.

Lastly, it is needless to say that all other pneumatic apparatus may also be utilised for this purpose, if only they are so constructed that the necessary rarefaction of air can be rapidly and surely effected.

#### MODE OF ACTION.

The effect produced by diminution of the pressure on the surface of the body is to facilitate and amplify the inspiratory act and increase the inspiratory dilatation of the lungs.

When the pneumatic 'Panzer' is placed on the patient, or he is put into the pneumatic 'Wanne' and the air is rarefied, not only is traction exercised upon the external surface of the thorax, which, if it still possesses sufficient mobility, strives to meet it, and thereby assists the action of the inspiratory muscles in inspiration; but the pulmonary air also, now standing under higher tension will tend to expand as compressed air does after its inspiration, and exercise pressure outward, while at the same time the denser atmospheric air flows into the air passages of the patient in larger quantity, corresponding to the degree of rarefaction in the 'Wanne.'

The effect of the treatment is mainly dependent on its overcoming the obstacles which interfere with the activity of the respiratory muscles, and therefore supposes a definite force resulting from the degree of rarefaction of the air, which Hauke has calculated from the amount of the positive and negative forces coming into action in inspiration. According to his calculations, if  $M$  represents the strength of the inspiratory muscles,  $w$  the resistance on the part of the thoracic wall,  $E$  the elasticity of the lungs, and  $v$  the rarefaction occurring in

inspiration on account of the narrowed air passages, the expression  $M > W + E + v$  holds for inspiration. The amount of  $w$  is not yet obtained; in children it is certainly much slighter than in adults. Donders estimates  $E$  at 30 millimetres Hg =  $\frac{4}{100}$  atmosphere, i.e. the contractile power the lung exercises on the inner surface of the thoracic wall is strong enough to rarefy a given quantity of air in the pleural sac by  $\frac{4}{100}$  atmosphere. In children this valuation is certainly not much less, as it is based upon the action of elastic and organic muscular fibres, and a smaller transverse section also corresponds to the smaller quantity. Hauke has obtained the value of  $v$  by experiments on children from four to nine years old, and found it to be between  $\frac{1}{200}$  and  $\frac{2}{100}$  atmosphere. If we desire to overcome at least the two last obstacles  $E$  and  $v$  in favour of the inspiratory force, we must effect diminution of pressure on the outer surface of the thorax proportionate to the value of  $E$  and  $v$ , i.e. a rarefaction of air by approximately  $\frac{5}{100}$  atmosphere: thereby the air pressure in the lungs acquires a proportionate excess weight over the pressure upon the external thoracic surface; the chest walls assume a new, somewhat higher state of equipoise, and their inspiratory dilatation occurs more easily, because  $M$  has only to overcome  $w$ . The amount of saving of strength to the inspiratory muscles is as follows: the whole atmospheric pressure on a square centimetre being approximately 1 kilogramme,  $\frac{1}{20}$  kilogramme on each square centimetre of the mobile thoracic surface, therefore 20 kilogrammes, if the latter be taken at 400 cubic centimetres, and all this economy of strength is to the advantage of the inspiratory muscles in the elevation of the thoracic wall.

Let us now suppose the rarefaction of air suddenly interrupted at the completion of inspiration and giving place to full atmospheric pressure; expiration will occur freely with a force which finds expression in the formula  $M' + w + E$  if  $M'$  represents the inspiratory muscles,  $w$  and  $E$  the above-named amount. But so rapid a change of the density of air as the great frequency of children's respiration would require, and which undoubtedly would exercise the most powerful influence on its mechanism, cannot be carried out in practice, and we must therefore be satisfied with establishing and interrupting

the rarefaction of air in pauses which embrace a longer or shorter series of respirations.

If we now consider the influence of such a continuous rarefaction of air on the respiratory movements, it is clear that the expiration must be impeded in the same degree as the inspiration is facilitated. That portion of force is lost to respiration which must be spent in first establishing the equilibrium between internal and external pressure; expiration now follows when the diminution of pressure corresponds to the amount of  $E$ , only with the force of  $M' + w$ . The result of this is that spontaneous respiration with continuous rarefaction of the air surrounding the thorax by  $\frac{1}{20}$  atmosphere will take place with sufficient force, even though the expiration is impeded. On the other hand, if the rarefaction of air exceeds the amount of  $E$ , especially in the case of quite young children exhausted by illness, a condition of complete apnoea may set in. Besides the negative pressure exercised upon the thorax during a series of expirations must also influence the circulation of the blood, as the volume of the lungs is permanently dilated beyond the normal, and the increased elasticity of the lungs corresponding to this degree of dilatation will exert a stronger aspiratory effect on the blood flowing back to the heart from those vascular circles which are not under the influence of the rarefied air.

### 1. *Theory of Forced Inspiratory Expansion of the Thorax.*

Hauke asserts that the artificially induced inspiratory expansion of the thorax by the action of negative pressure upon it is not completed in a single inspiration, but, according to experience, requires from 3 to 5.

So soon as the air is rarefied in the 'Panzer' the atmospheric air flows into the lungs in considerably larger quantities than would be the case in the intended inspiratory act; the result of this is that the laryngeal sound becomes stronger, and in the earliest sittings even a slight sound of singultus is sometimes heard, evidently because the glottis is not sufficiently widened for the large quantity of air. The more rapid dilatation of the lung, however, excites the retarding fibres of the vagus before the inspiratory expansion of the thorax is quite com-

pleted. The next inspiration finds the thoracic wall already in a higher position of equilibrium, because the expiration is impeded by the rarefaction of air in the 'Panzer.' When at last the lung attains to the greatest dilatation the respiratory movements are arrested, owing to the strong excitement of the retarding fibres of the vagus, and perhaps also to impeded expiration.

If now the full atmospheric pressure is rapidly restored in the 'Panzer,' for the same reason the retraction of the thorax occurs, not at once, but during several respiratory acts, in which, as the respiratory sound shows, expiration is more energetic than inspiration. The greater the rarefaction of air employed and the quieter the children are during the sitting, the more distinctly can these phenomena be observed and the change of air pressure in the 'Panzer' be regulated accordingly. Besides the rhythm of natural respiration, a second respiratory type is thereby established, also with an inspiratory and expiratory phase; but 3 to 5 and even more respirations occur in each of the two phases. It is, however, questionable whether the deeper inspirations produced by this method really attain the maximum of the inspiratory expansion of the thorax; without intentional co-operation of the inspiratory muscles this maximum will not be attained, especially in the case of very restless children. But it is evident, from the respiratory type described, and from the clearing of previously non-resonant parts of the lung, that respiratory function is increased, and that by means of the generally and uniformly diminished external pressure the air streams even into those parts of the lung which in spontaneous respiration have little or no share in the respiratory act. At any rate the lung is thrown into a state of higher tension during the continuance of rarefaction of air in the 'Panzer,' and the thoracic aspiration thereby correspondingly increased.

The greatest facilitation of respiration, and the greatest effect with regard to the ventilation of the lungs and influence upon circulation, can, however, only be obtained when the respiratory type resulting from the rarefaction of air in the 'Panzer' fully adapts itself to the rhythm of spontaneous respiration. This harmony, however, is only possible when both respiration

itself proceeds slowly and the inspirations are carried out as deeply as possible by the influence of the will; unfortunately, these conditions never occur in the case of sick children (Hauke).

2. *Experiments on the Dead Body and Therapeutic Researches.*

Hauke, in order to prove the accuracy of his predictions and the efficiency of the new method, experimented on the bodies of four children, to induce respiration without the co-operation of the organism, and to expand the foetal lungs sufficiently.

(a) The body of a child two years of age recently dead. Each time the air was rarefied in the 'Panzer' the atmospheric air streamed into the lungs of the cadaver, and rapidly flowed out again when the atmospheric pressure was restored in the 'Panzer.' The quantity of air expired, collected under water, amounted to 80 to 100 cubic centimetres for each respiration; 10 to 15 of such medium respirations were quite easily performed in a minute.

(b) A premature birth in the seventh month of pregnancy. Weight 2,100 grammes; thoracic periphery 24 centimetres; abdominal periphery 25 centimetres; experiment 50 hours after birth. With the first expiration a strong cadaveric smell was diffused. The collection of the expired air was incomplete. After the close of the experiment the thoracic periphery amounted to 25 centimetres, the abdominal to 27 centimetres. In section the lungs were found to be inflated, bright rose red; only the anterior inferior margins of the right median lobe remained atelectatic, several air vesicles under the pleura. Right-sided pneumothorax, and in the pleura a little fissure which could be followed one centimetre deep into the pulmonary tissue.

(c) A mature, stillborn child. Experiment 24 hours after birth; thoracic periphery 25 centimetres; abdominal periphery 27 centimetres, after the experiment 28 and 29 centimetres. The lips gape with each expiration and cause the air to flow out with a murmur; the attempt to collect the expiratory air again fails. Section: Left lung containing air, rose red; in the inferior lobe about one quarter of the posterior surface bluish red, collapsed to the depth of 5 millimetres; no emphysema.



The atelectatic parts could only be inflated with great effort. The stomach, duodenum, and the upper part of the jejunum filled with air, while the rest of the intestine was well contracted.

In order to compare the effect of this process with that of insufflating air the following experiment was performed with compressed air.

(d) Stillborn child. In air condensed by  $\frac{3}{100}$  atmosphere in the pneumatic apparatus 15 to 20 insufflations in the minute with 45 cubic centimetres of air each were performed; when the pressure was raised to  $\frac{4}{100}$  atmosphere 20 to 30 insufflations with 75 cubic centimetres volume of air each. The use of the catheter was a hindrance and during insufflation much air streamed out beside it. Attempts to aspire air out of the lungs do not succeed, even with the aid of the catheter. In opening the peritoneal cavity the greatly distended stomach was opened with it. The lungs were very full of air, sub-pleural emphysema at the surface of the right inferior lobe; under repeated insufflation with open thorax the vesicles gradually enlarged up to the size of hazel nuts; in the attempt to insufflate air in the same manner one of these vesicles immediately burst.

These experiments prove that natural respiration may be satisfactorily replaced by the above-described pneumatic procedures and fetal lungs sufficiently distended. In the living child the mischievous secondary effects, sub-pleural emphysema and filling of the stomach with air, may be warded off by the employment of a slighter but still effectual rarefaction of air and by placing a bandage round the body.

As, however, post-mortem experiments do not afford a reliable criterion as to the possible danger of the method, because, on the one hand, rigor mortis impedes the thoracic expansion, on the other putrefaction promotes the laceration of the tissue, Hauke has also submitted a large number of children suffering from various pulmonary affections to pneumatic treatment, partly ambulatory, partly stationary, in the institution. The former were usually brought to the institution daily at the outset of the treatment, then less frequently, often quite irregularly; with the latter at least one, but generally two sittings a day were undertaken for five to ten minutes.

The total result of all these experiments was the positive assurance that by the treatment employed the contents of air in the lungs may be increased, and portions of the lungs filled with air which were entirely destitute of it. The experimenters inferred this effect from frequently observing increased resonance of the percussion note and especially from the diminution or entire disappearance of marked circumscribed dulness. The latter was, as autopsy proved, induced in one case by atelectasis from compression, in another case by induration of the lungs; in the third case this phenomenon was the result of an old pulmonary cavity in the indurated tissue. In several cases of chronic infiltration of the lungs the appearances of resolution occurred immediately after the commencement of the pneumatic treatment; in another case resolution, absorption, and expectoration were perceptibly promoted. In all cases of chronic pleuro-pneumonia pneumatic treatment has unmistakably contributed to rapid expansion of the lungs, in other cases of chronic stationary pleuritic exudations, to rapid absorption without affecting the thoracic retractions. Lastly, pneumatic treatment was decidedly favourable in its effect on the general health, as it led to improvement in appearance and strength, and sometimes to astonishing increase of body weight.

Hauke considers that the essential factor in these results is better ventilation of the lungs and the consequent increased arterialisation and decarbonisation of the blood, as well as the promotion of circulation of blood and lymph, which the method indubitably, though perhaps only temporarily, excites. The effects themselves are the result of deeper respirations and of the elevation of the thorax when at rest during the rarefaction of air in the pneumatic 'Panzer.'

#### INDICATIONS.

From the mechanical effect of negative pressure on the thoracic walls, as it may be exercised by rarefaction of air in the pneumatic 'Panzer' or the pneumatic 'Wanne,' the treatment is indicated in the following affections.

### 1. *Asphyxia.*

The object of medical assistance in the case of asphyxiated newborn infants consists in the excitation of artificial respiration and circulation.

Since in this method of restoration to life, as in the natural respiratory traction of the inspiratory muscles, the thorax is dilated and traction is exercised upon the external surface of the lungs, whereas every other mode of artificial respiration, whether by compression of the thorax or by insufflation, has for its result first a compression of the lungs and an increase of intra-thoracic pressure, therefore in this case not only does the atmospheric air penetrate at once into the air cells and inflate them, but the enlargement of the pulmonary space and the negative pressure thereby exerted also immediately exercise an aspiratory influence on the venous blood. The right auricle becomes filled with venous blood and forces it in the expiratory subsidence of the thorax into the right ventricle, and after renewed filling farther on into the pulmonary arteries. The blood contained in the pulmonary vessels is with the first expansion of the lungs forced into the pulmonary veins and at the same time drawn into the left auricle. In the succeeding collapse of the lungs their vessels become filled with the blood from the right ventricle. Therefore by this process not only respiration but also circulation of the blood is established in the most rational and efficient manner.

### 2. *Congenital Atelectasis.*

Even in cases in which the respiration of a newborn infant is imperfectly performed because either liquor amnii or mucus obstruct parts of the air passages, the stronger filling of the lungs with air by means of pneumatic treatment will promote expectoration, or the air streaming in under higher pressure will diffuse it over a wider space and make its evaporation possible. So also, Hauke maintains, in the case of children born with slight cerebral pressure who after the action of strong cutaneous stimulation, in the warm bath and with warm covering, respire energetically, but when this stimulation decreases

in intensity threaten to become again asphyxiated, especially when their organs are immature or imperfectly developed; therefore children who have come into the world with feeble vitality, in whom, owing to great softness of the thoracic walls, the lungs are not sufficiently distended, respiration will be strengthened by pneumatic treatment and their lives preserved.

### 3. *Catarrhal, Chronic, and Croupous Pneumonia and Pleuro-pneumonia.*

Among the various forms of inflammation of the parenchyma of the lungs upon which pneumatic treatment is capable of exercising a material influence must especially be reckoned those forms of catarrhal pneumonia of weak children or those who have been reduced by previous illness, and proceeding from a bronchial catarrh, which tend to set up atelectasis in a chronic or subacute manner.

Since, owing to the weakness of the respiratory muscles, the children can no longer expectorate the mucus accumulated in the swollen and narrowed bronchi, and the bronchi, especially the greater ones, thus become blocked up, the air shut up in the air cells becomes gradually absorbed, the alveolar walls collapse, and a catarrhal inflammation is developed with serous infiltration of the tissue, adipose degeneration of the alveolar contents, and localised nuclear proliferation. The more unfavourable the situation of the several portions of the lungs for expansion and admission of air, e.g. the posterior parts of the inferior lobes and the margins of the lungs, the more frequent and rapid will be the development of atelectasis and lobular infiltration. The catarrhal pneumonias thus originating always follow a very protracted course, not unfrequently extending over six or eight weeks, and the danger of caseous metamorphosis of the inflammatory products is always imminent. The diminished exchange of gases in the lungs leads to accumulation of carbonic acid in the blood, paralysing the heart, so that the latter is no longer able to overcome the obstructions in the pulmonary circulation, fresh atelectatic parts arise, and engorgement of blood, especially in the brain, and a low state of nutrition may lead to a fatal issue.

Pneumatic treatment acts more rationally and thoroughly on the whole group of symptoms than any other therapeutic method, as it induces, by the mechanical expansion of the lungs, conditions in the respiration and circulation directly opposed to those which lie at the root of the phenomena in question. By means of the complete carrying out of the inspiratory act existing atelectatic parts may be re-expanded by enlargement of the respiratory surface and by better decarbonisation and arterialisation of the blood, the cardiac force may be increased, and by this means, as well as by raising the thoracic aspiration, the danger of hyperæmia may be diminished. In individual cases, however, it must always be difficult to estimate beforehand the influence of the fever, of bronchitis, and already existing infiltrations on the course and issue of the malady.

#### 4. *Chronic Stationary Pleuritic Exudations.*

The points of view from which pneumatic treatment by a greater or less negative pressure on the thoracic surface is applicable in pleuritic exudations are the same as those for the inspiration of compressed air in the same conditions.

In the first place, by the general mechanical influence of the treatment, the inspiratory dilatation of the thorax is facilitated, reduced as it has been by partial insufficiency of the inspiratory muscles of the affected side resulting from the pressure which the exudation exerts on the diaphragm, or by serous infiltration of the muscles themselves as a sequel of the previous acute inflammatory stage, or by pain. The exudation, which has accumulated in the pleural cavity, not only compresses the lung and impedes its aspiratory suction as it expands in inspiration, whereby the circulation of the blood and lymph are materially interfered with, but it also exercises a direct pressure on the venous trunks and on the auricles of the heart, which retards the flow of venous blood and lymph to the right auricle and impedes its filling, while on the other hand it influences the exchange of gases by reducing the area of the pulmonary arteries, lessening the amount of arterial blood, and setting up venous engorgements. A part of these phenomena will always be more or less compensated for by the

artificial expansion of the thorax and the consequent increase of its aspiratory power, as well as by the reduction of the pressure which the exudation exercises on the thoracic organs, and by the more rapid absorption of the exudation which the stimulation of the circulation will induce.

As compressed air by pressure acting from within outwardly, so the negative pressure acting by traction on the external surface of the thorax is also capable of antagonising the depression of the thoracic walls which gradually occurs in long-standing exudations. In the case of children, even more than in adults, when the lung is covered with thick membranes and can no longer expand sufficiently, as the exudation filling the pleural cavity is being absorbed, the external atmospheric pressure must act upon the soft and yielding thoracic walls and compress them, so that by curvature of the spine, elevation of the diaphragm, and dislocation of the heart the space left by the disappearance of the exudation is filled up. The best remedy in this case will always be expansion of the lungs by suitable pneumatic treatment, which especially reduces the pressure of air on all the walls of the secreting cavity, while the full atmospheric pressure acts upon the inner surface of the lungs. The greatest possible re-inflation of the lung tissue and prevention of secondary thoracic deformities is also best effected by this treatment.

Hauke claims special efficiency for this treatment in cases where, as a result of thoracentesis, or in a penetrating chest wound, pneumothorax is present, and fresh air streams into the thoracic space at every inspiration. Here, in proportion as the air is rarefied in the 'Panzer,' a definite quantity of air would be sucked out of the pleural cavity, with a rarefaction of  $\frac{1}{20}$  atmosphere, at least the twentieth part; and should the expansibility of the lungs be intact, in traumatic pneumothorax a single rarefaction of air in the 'Panzer' would suffice for complete expansion of the lungs. If by means of a valve-acting bandage or a caula with valve opening outwards we prevent the entrance of air after we have established the atmospheric air pressure in the 'Panzer,' the space must immediately, if it is at all possible, be filled up by the re-expanding lungs.

Pneumatic treatment affords a certain protection even

against subsequent affections of the lungs, to which they are prone after incomplete re-expansion and persistent adhesions of the pleural surfaces, such as chronic inflammatory processes resulting in caseous degeneration and tuberculosis, and it acts by promoting the complete expansion of the lungs, especially of their margins, with the utmost possible compensation for the abnormal circulation and the greatest possible expansion of the adherent spots.

Pneumatic treatment is counter-indicated in the acute stage of pleurisy, as well as in those grave cases in which the diseased side of the thorax is distended to the maximum of the inspiratory position by the amount of the exudation, also in distinctly purulent exudations, before the discharge takes place either in the natural way or by operation. (Cf. *supra*, Pleuritis.)

### 5. *Croup.*

The employment of the pneumatic 'Wanne' or the pneumatic 'Panzer' appeared to Hauke at first specially calculated to meet the dangers which threaten the life of a child in croup.

He was of opinion that by the relief given to the inspiratory muscles during pneumatic treatment the danger of respiratory insufficiency would be kept under, and the apnœa, which is aggravated by the intensified action of all the respiratory muscles, and the consequently increased consumption of oxygen, would be diminished. Further, he considered that by better ventilation of the lungs the danger of carbonic acid poisoning, and by increase of thoracic aspiration the results of hyperæmia, would be averted and the lung tissue guarded from the mischievous consequences of the dragging to which it must be subjected by the laboured inspiration attending impeded ingress of air; lastly, the cough would be looser if the child could command a larger amount of air for the purposes of forced expiration and expectoration.

Unfortunately the results have not been equal to the hopes which Hauke entertained of this treatment. The unfavourable issue of the experiment, however, is chiefly due to the unsuitability of the cases, for in diphtheritic and scarlatinous affections of the air passages not only is there obstructed respiration, but

the prognosis is rendered unfavourable, and a fatal result often unavoidable, on account of the general infection.

Pneumatic treatment had no injurious consequences in those cases which were characterised by marked stenotic symptoms, though it failed to produce that influence on the respiration which we have described.

### 6. *Rachitis.*

In rachitic affection of the thorax the pneumatic 'Panzer' acts principally as an orthopædic apparatus to antagonise the deformity resulting from the disease, viz. narrowing of the thorax and obstruction of the respiration, owing to the softness of the ribs.

The smallness of the rachitic thorax is due to a shortening of the lateral and vertical diameters, while the antero-posterior diameter may be even somewhat increased, owing to the projection of the sternum. The thoracic space will also be encroached upon by the increased upward pressure of the diaphragm in consequence of the intumescence of the intestines, which is so common in rachitic children.

The typical change of form of the thorax is dependent upon the retractile effort of the elastic lung tissue, which acts first on the most yielding parts, the lung cartilages of the fourth to the seventh ribs, and then the softened costal bones themselves, while those parts which are less exposed to the traction of the lungs and are supported by stronger bones, such as the sternum and the vertebral column, do not sink in, but on the contrary project, owing to the altered course of the ribs. Consequently there is only a slight flattening of the submammary region and a more marked depression of the lateral part of the thorax, with projection of the sternum, to be observed. During the inspiratory dilatation of the thorax and the consequent rarefaction of the air, the softened lateral parts of the thorax are still more compressed by the external atmospheric pressure, and the inspired volume of air is yet further diminished.

Since the decrease of respiratory volume necessarily involves the obstruction of thoracic aspirations and a defective arterialisation of the blood, we get on the one hand disturbances of



nutrition and venous engorgements, which are brought about by even slight impediments to the circulation, and on the other hand diminished excretion of water and dryness of the tissue, owing to the slight exchange of air in the lungs, a tendency to perspiration, to catarrhs with difficult expectoration, the necessary consequences which are even theoretically deducible from the change in the thoracic space. The treatment of these disturbances, apart from the necessary dietetic rules and the internal treatment demanded by rachitis as such, can be effected only by mechanical methods through which all parts of the thorax are uniformly drawn outwards and its diameters are made greater than in normal deep inspirations. As the ordinary inducement to deep inspirations by external excitement of the skin, such as the application of cold water, has precisely the opposite result, viz. a sinking in of the thorax, and pressure from within outwards by inspiration of compressed air, whereby the pressure of the pulmonary air would obtain the preponderance over the external atmospheric pressure, is not practicable, the idea (Hauke) of exerting a negative pressure on the thoracic surface while inspiration with full atmospheric pressure acts as an expansile force from within must be termed a specially happy one, as it attacks the existing mechanical disturbances most directly. At the same time the softness and pliability of the rachitic thorax, upon which its original changes of form depend, will now co-operate in establishing the opposite changes and increasing the therapeutic effect.

## II. ACTION OF POSITIVE PRESSURE ON THE SURFACE OF THE THORAX.

The method discovered by Hauke, more or less independent of the will of the patient, of an inspiratory expansion of the thorax by traction applied to the thoracic walls, has not up to the present time found an equivalent in the opposite direction, by means of which general pressure from without should cause a diminution of the thoracic space or restore its boundaries from a permanent inspiratory position to that of equilibrium previously occupied.

Hauke's attempts to cause compressed air to act upon the

thoracic walls in the same way as rarefied air does in the opposite sense have for the present led to no result, as he has not succeeded in finding a perfectly airtight-fitting 'Panzer' or 'Wanne.' If, therefore, we desire to exercise positive pressure upon the thoracic walls, independent of the will of the patient, and thereby directly effect a diminution of the thoracic space, we must for the present be content to bring about the desired pressure on the thoracic surface by other mechanical means.

The method of influencing expiration by compression of the thorax, and of diminishing the thoracic space and the pulmonary capacity, is really an old one, and has been considerably practised in hygienic gymnastics. It may be carried out by two methods—

1. An indirect, physiological one, specially belonging to hygienic gymnastics, according to which the diminution of the thorax and the completion of expiration are obtained by forced activity of the expiratory muscles, with the co-operation of those movements of the extremities, especially the superior, and of the body which bring about compression of the thorax, and

2. A directly mechanical one, by which another person during the expiratory act exercises a pressure from without on the thorax, whereby its movable walls are pressed together.

As in the mechanical influence exerted by altered air pressure, so here also the amount of success is partly dependent on the removal of accidental impediments which stand in the way of manual pressure, especially the build of the thorax as it is modified by age and various pathological processes. The result will be the more satisfactory the more elastic and flexible the costal cartilages still are, so as to give full play to the pressure applied. In employing the method therapeutically, it may be used either alone, to obtain certain determined effects, or altered air pressure on the pulmonary surface may be combined with it in the like or in the opposite sense. The following modes of action will then have to be distinguished:—

1. By manual pressure alone, as such, the capacity of the thorax is diminished, a pressure is exercised on the lungs, and the air contained in the pulmonary alveoli is removed. This procedure also completes expiration by removal of a portion of

the residual air. It will thereby exercise a favourable influence in all cases in which expiration is impeded or insufficient, especially in dilatation of the lungs, emphysema and its consequences. This mode of action is therefore increased by expiration into rarefied air, as at the same time that expiration is aided by manual pressure on the outer surface of the thorax a negative pressure, or rather aspiration, is exercised in a like direction on the pulmonary surface.

2. This pressure will not only force the air out of the air cells, but also exercise a compression on all the thoracic organs, and consequently also lead to a narrowing of the pulmonary blood channel and a forcing of blood out of the lungs. That will be all the more the case if the pressure from without inwards meets a free action in the opposite direction from within outwards by inspiration of compressed air: here the necessary consequence will be a copious disengorgement of the lesser circulation. The same pressure will, however, act at the same time on the exudations existing in the thoracic space, and induce a more rapid absorption of them than can be induced by the local pressure of condensed air only, on the inner surface of the lungs.

According to Gerhardt's observations, the following therapeutic effects are to be obtained by the methodical application of manual pressure on the external surface of the thorax, applied during the expiratory act:—

1. An elevation of the diaphragm, consequently a reduction of the dilated lungs;
2. Increase of vital capacity;
3. Decrease of respiratory frequency;
4. Promotion of expectoration.

As regards the last effect, Gerhardt is of opinion that those cases in which viscid secretion causes the occlusion of a part of the air passages, which cannot be overcome by the feeble muscular force, are specially adapted for the above-described mechanical treatment. In this case the expiratory pressure is directly strengthened by the concomitant manual pressure from without, and expectoration is also indirectly promoted by the more vigorous muscular activity resulting from increased supply of oxygen.

Indications for the application of manual pressure are not limited to pulmonary emphysema only, but will extend to other pathological conditions in which the same symptoms occur.

Thus Gerhardt treated a hospital patient with large bronchiectatic cavities in the left lower lobe of the lung on the same principle. By inhalations of turpentine he succeeded very soon in removing the odour of the sputa, but physical examination showed the cavities to remain permanently filled for several days; the amount of expectoration was small. This retention of the sputa was prevented by mechanical promotion of expiratory pressure in the right lateral position, which was undertaken daily during the visit. I have myself always obtained very favourable results through manual pressure during and especially at the close of inspiration, in cases of abundant secretion and difficult expectoration in bronchiectatic lungs, and Hausmann has published a series of cases in which he obtained similar results where the same indications existed in phthisical subjects, with simultaneous use of continuous inhalations of carbolic acid, tar, or oil of turpentine by means of the medicated respirator.

The simplicity of the considerable expiratory effect obtained from this method is, however, attended with drawbacks which involve dangers in two directions, pulmonary hæmorrhages and muscular convulsions.

In the cases of two patients treated with manual pressure for a considerable time by Gerhardt pulmonary hæmorrhages occurred only a short time after the treatment was commenced. The slight elevation which the blood pressure undergoes by this method may suffice to cause rupture in fragile portions of the vascular walls. In the case of one of the patients who suffered from bronchial catarrh with abundant secretion, in addition to emphysema, the treatment was cut short by the appearance of twitchings round the corners of the mouth. Gerhardt accounted for these phenomena in this manner: that from the pressure exercised more carbonic acid was absorbed from the obstructed air spaces of the lungs into the blood, or at least none was given off from thence, so that there was a temporary increase of the accumulation of carbonic acid.

I have for years employed the combination of manual pressure of the lungs with expiration into rarefied air in diffuse

emphysema, and observed in consequence a free evacuation of the residual air ; so also when complicated with chronic catarrh with profuse secretion, a perceptible increase of expectoration. It will always be advisable at the commencement of a pneumatic sitting to combine the pressure with the first 40 to 60 expirations, and to cause the following expirations, which are generally perceptibly fuller than when not preceded by pressure, to occur in the ordinary manner. The sittings may be repeated 2 or 3 times a day.

Brügelmann has also tried the same method of treating emphysematous lungs in his institution, with satisfactory results. His mode of action is as follows : The patient must stand on a footstool and open coat and waistcoat, also unfasten his braces ; a lady will appear in a loose morning wrapper without stays ; the assistant places himself in front of the patient in a somewhat inclined position, and lays the palms of both hands in the axillary region. Brügelmann now causes the pressure to be applied at the very commencement of expiration into rarefied air, which is preceded by a deeper inspiration, and it is continued till the expiration is completed. It is, however, decidedly better not to begin the pressure till during or towards the close of expiration, as the result will thereby be far more satisfactory and the assistant will not be so soon tired out. It is also quite unnecessary to cause a deep inspiration to precede expiration into rarefied air, as the lungs are sufficiently expanded and the air to be pressed out is therefore needlessly increased. Brügelmann also orders the pressure to be undertaken only at the commencement of each sitting with the first boiler of Waldenburg's apparatus, which he uses, while the other boilers are used without pressure, so that they are filled by the expiration of the patient far more rapidly than without previous pressure.

We have as yet no observations worth mentioning upon the effects of manual pressure on the surface of the thorax combined with that of the opposite pressure of inspiration of compressed air on the inner surface of the lungs. The system suggested by Cube and Cron of aiding the influence of compressed air in the treatment of pleuritic exudations, by lying on the side, is a part of this method and to be classed under it (cf. *Pneumatic Treatment of Pleuritic Exudations*).

## SECTION II.

CHANGES OF AIR PRESSURE, ACTING GENERALLY, IN THE  
PNEUMATIC CHAMBER.

## BIBLIOGRAPHY.

- Hamel: 'Lettre au Professeur Pictel sur la Cloche de Plongeurs,' *Bibl. Univers. des Sciences, Belles-lettres et Arts de Genève*, 1820, part xiii.—Colladon: *Relation d'une Descente en Mer dans la Cloche de Plongeurs*. Paris, 1826.—Théodore Junod: 'Recherches sur les Effets Physiologiques et Thérapeutiques de la Compression de l'Air, tant sur le Corps que sur les Membres Isolés,' *Archives Générales de Médecine*, 1835, ii. sér. ix. pp. 157-172.—Id.: 'De la Condensation et de la Raréfaction de l'Air, &c., considérées sous leurs Rapports Thérapeutiques,' *Compt. Rend.*, 1835, part i. p. 60.—Id.: 'Appareils destinés à augmenter ou à diminuer, selon le cas, la Pression Atmosphérique sur une partie plus ou moins grande de la Surface du Corps Humain,' *Compt. Rend.*, 1838, part vi. p. 654.—Id.: 'Mémoire sur de Nouveaux Perfectionnements apportés à la construction d'un grand Appareil dit "Cloche Pneumatique," destiné pour toutes les parties du Corps,' *Compt. Rend.*, 1838, part vii. p. 973.—Emile Tabarié: 'Recherches Physico-physiologiques,' *Compt. Rend.*, 1838, part vi. p. 477.—Id.: 'Mémoire sur un système de Bains d'Air généraux ou locaux, applicables à l'Hygiène et à la Thérapeutique et fondés sur les modifications que l'on peut faire subir à la Pression de l'Atmosphère,' *Compt. Rend.*, 1838, part vi. p. 896.—Ch. G. Pravaz: 'Mémoire sur l'Emploi du Bain d'Air Comprimé dans le traitement des Affections Tuberculeuses, des Hémorrhagies Capillaires et des Surdités Catarrhales,' *Compt. Rend.*, 1838, part vii. p. 283.—Franceur: A Letter to Arago, *Compt. Rend.*, 1839, part viii. p. 413.—Emile Tabarié: 'Sur l'Action Thérapeutique de l'Air Comprimé,' *Compt. Rend.*, 1840, part xi. p. 26.—Ch. G. Pravaz: 'Observations relatives aux Effets Thérapeutiques des Bains d'Air Comprimé,' *Compt. Rend.*, 1840, part xi. p. 910.—Id.: *Mémoire sur l'Emploi de la Compression au moyen de l'Air Comprimé dans les Hydrarthroses, &c.* Lyon, 1843.—Dubreuil: *Bains d'Air Comprimé*. Marseille, 1848.—P. Hervier: 'Sur la Carbonométrie Pulmonaire dans l'Air Comprimé,' *Annuaire de Chimie*, 1849, p. 598.—Ch. G. Pravaz: 'Note sur la Pression Atmosphérique dans ses rapports avec le Mécanisme de la Respiration, le Phénomène de l'Hématose et la Circulation Capillaire.' *Bulletin de l'Académie Nationale de Médecine*, 1850, part xv. p. 520.—Id.:

*Essai sur l'Emploi Médical de l'Air Comprimé.* Paris, 1850.—Triger: 'Sur un Nouvel Emploi de l'Air Comprimé,' *Compt. Rend.*, part xxi. (1850).—Th. Poyser: 'On the Treatment of Chronic and other Diseases by Baths of Compressed Air,' *Association Medical Journal*, September 9, 1853.—Dom. Bottini: *Gaz. Med. Ital. Stat. Sard.*, 1853.—Fr. Devay: 'Du Bain d'Air Comprimé dans les Affections graves des Organes Respiratoires et particulièrement dans la Phthisie Pulmonaire,' *Gaz. Hebdom. de Méd. et de Chirurg.*, tome i. No. 11, 1853.—B. Pol et T. J. J. Watelle: 'Mémoire sur les Effets de la Compression de l'Air appliquée au Creusement des Puits à Houille,' *Annales d'Hygiène Publique et de Médecine Légale*, 1854, Avril, 2<sup>e</sup> sér. tome i. 2nd part, p. 241.—A. Guérard: 'Note sur les Effets Physiologiques et Pathologiques de l'Air Comprimé,' *Annal. d'Hygiène Publique et de Méd. Légale*, 1854, 2<sup>e</sup> sér. tome i. part ii. p. 279.—E. Bertin: *Etude clinique de l'Emploi et des Effets du Bain d'Air Comprimé dans le Traitement de Maladies de Poitrine, notamment dans le Catarrhe Chronique, l'Asthma et la Phthisie Pulmonaire selon les Procédés Médico-pneumatiques ou d'Atmosphère.* Paris et Montpellier, 1855 (2nd edition, 1868).—J. Milliet: *De l'Air Comprimé comme Agent Thérapeutique.* Lyon, 1855.—Id.: 'De l'Air Comprimé au Point de Vue Physiologique,' *Gaz. Médic. de Lyon*, 1856, Nos. 9 and 10, pp. 172–196.—Schutz: Letters from Nice, *Deutsche Klinik*, 1857, Feb. 28.—A. Simpson: *Compressed Air as a Therapeutic Agent.* Edinburgh, 1857.—Lamey Fleury: 'Sur les Effets de l'Air Comprimé,' *Revue des Deux-Mondes*, 1857, Nov. 1.—D. Bottini: 'Dell' Aria Compressa come Agente Terapeutico,' *Gaz. Medic. Ital. Stat. Sard.*, 1857, No. 28 (*Gaz. Médic. de Paris*, 1858, p. 781).—E. Houghton: 'On the Use of the Compressed Air Bath,' *Dublin Hospital Gaz.*, 1858, No. 4.—J. C. T. Pravaz (fils): *Des Effets Physiologiques et des Applications Thérapeutiques de l'Air Comprimé.* Paris et Lyon, 1859.—'Des Effets Physiologiques de l'Air Comprimé: Observations faites au Pont de Szegedin,' *Annales des Ponts et Chaussées*, 1859, part xvii.—François: 'Des Effets de l'Air Comprimé sur les Ouvriers travaillant dans les Caissons servant de base aux piles du Pont du Grand-Rhin,' *Annal. d'Hygiène Publ. et de Méd. Lég.*, 1860, 2<sup>e</sup> sér. part xiv.—E. Bertin: *Etudes sur l'Emphysème Vésiculaire des Pouxons, sur l'Asthme et sur leur Guérison par le Bain d'Air Comprimé.* Paris et Montpellier, 1860.—R. v. Vivenot, jun.: 'On the Influence of Altered Air Pressure on the Human Organism,' *Virchow's Archiv*, vol. xix. 5, 6, 1860.—Gindrod: *The Compressed Air Bath as Therapeutic Agent in various Affections of the Respiratory Organs and other Diseases.* London, 1860.—Lippert: 'Ueber Paris nach Nizza,' Medical Travelling Sketches, *Deutsche Klinik*, 1861, No. 41.—E. Bucquoy: *Action de l'Air Comprimé sur l'Economie Animale.* Strasburg, 1861.—R. v. Vivenot: 'On the Therapeutic Use of Condensed Air and Construction of an Apparatus for Compressing Air at Vienna,' *Wochenblatt der Zeitschr. der k. k. Gesellsch. der Aertze in Wien*, 1862, Nos. 28, 29, and 30.—F. Glaisher: *British Medical Journal*, 1862, vol. ii. p. 625.—O. Th. Sandahl: 'Om Verkningarne af Förtätad Luft pae den Menskliga Organismen, i Fysiologiskt och Terapeutiskt Hänseende,' *Med. Arkiv utgivet af Läkare vid Karolinska Institutet in Stock-*

holm, 1862.—J. C. T. Pravaz (fils): *De l'Emploi et du Mode d'Action de l'Air Comprimé dans le Traitement des Différents du Thorax.* Lyon, 1863.—F. Trier: 'Om Bode i Fortaetet Luft,' *Ugeskrift för Laeger*, 1863. Kjöbenhavn.—E. Foley: *Du Travail dans l'Air Comprimé: Etude Médicale, Hygiénique et Biologique, fait au Pont d'Argenteuil.* Paris, 1863.—Tutschek: 'Compressed Air used Therapeutically from Studies and Observations made on this Mode of Treatment at Nice,' *Bayer. ärztl. Intelligenzbl.*, Nos. 18 and 19, 1863.—R. v. Vivenot: 'On the Setting up of a Pneumatic Apparatus at Vienna,' *Allgem. Wiener med. Zeitung*, Nos. 5 and 6, 1863.—G. Lange: *Wiener medicinische Wochenschrift*, Nos. 34 and 35, 1863.—E. Levinstein: 'Observations on the Action of Compressed Air in Diseases of the Respiratory and Circulatory Organs,' *Berl. klin. Wochenschr.*, 1864.—Freud: *The Pneumatic Apparatus: Influence and Application of Compressed Air in Various Diseases.* Vienna, 1864.—G. Fischer: *Mounting of an Apparatus for Compressing Air at Hanover*, 1864.—J. Lange: *On Compressed Air, its Physiological Effects and their Therapeutic Importance.*—Göttingen, 1864.—Dr. Josephson: 'The Therapeutic Application of Compressed Air without the Bell,' *Deutsche Klinik*, 1864, Nos. 44 and 45.—G. Bertin: *De l'Emploi du Bain de l'Air Comprimé dans le Traitement de la Surdité.* Montpellier, 1865.—R. v. Vivenot: 'On the Influence of Increased and Diminished Air Pressure on the Mechanism and Chemistry of Respiration,' *Medic. Jahrbücher der k. k. Gesellschaft der Aerzte zu Wien*, 1865, May, No. 3.—Id.: 'On the Increase of Lung Capacity from the Therapeutic Employment of Condensed Air,' *Virchow's Archiv*, vol. xxxiii. No. 1, 1865.—Id.: 'On the Changes in the Arterial System under the Influence of Increased Air Pressure,' *Virchow's Archiv*, vol. xxxiv. No. 4, 1865.—D. Jourdanet; *Gazette Hebdomadaire*, 1865.—O. Sandahl: *Nyare Undersökningar och Iakttagelser Rörande, de Fysiologiska och Therapeutiska Verkningsarne af Bad i Förtatad Luft.* Stockholm, 1865.—Id.: *Berättelse om den Medikopneumatiska Anstaltens verksamhet i Stockholm under Aren 1863 och 1864.* Stockholm, 1865.—E. Levinstein: *Principles of Practical Auristry with regard to the latest Therapeutic Technique and the Use of the Pneumatic Cabinet.* Berlin, 1865.—Smoler: 'The Employment of Compressed Air in Diseases of the Organ of Hearing,' *Austrian Zeitschr. für prakt. Heilkunde*, 1865, Nos. 19, 24, 28, 31.—O. Storch: *Jakttagelser over Virkningerne af comprimert Luft ved Behandlingen af Brystlidelser, meddelt fra Rasmussens medico-pneumatika Anstalt.* Kjöbenhavn, 1865 (separate impression from *Hospitals-Tidende*).—G. Lange: *The Pneumatic Apparatus: Communications relating to the Physiological Effects and Therapeutic Importance of Compressed Air.* Wiesbaden, 1865.—R. v. Vivenot: 'On the Changes of Bodily Warmth under the Influence of increased Air Pressure,' *Medic. Jahrbücher der k. k. Gesellschaft der Aerzte zu Wien*, 1866, No. 2, p. 113.—G. Lange: 'On the Treatment of Chronic Tuberculosis,' *Deutsche Klinik*, 1866, No. 30.—C. L. v. Elsässer: *Theory of Physical Phenomena in Compressed Air.* Stuttgart, 1866.—G. Bertin: *Analyse bibliographique de trois Brochures sur l'Air Comprimé.* Montpellier, 1866.—P. L. Panum: 'Fysiologiske Undersøgelser over dem i de pneumatiske Helbredelsesanstalter anvendte komprimerede



- Lufts Virkninger paa Organismen,' *Saerskilt Aftryk af Bibl. for. Laeg.*, 5, vol. xii. Kjöbenhavn, 1866.—Herm. and Robert v. Schlagintweit: *Results of a Scientific Mission to India and High Asia, &c.* London (Trübner) and Leipzig (Brockhaus), 1866.—D. A. Kryszka: 'Atmospheric Pressure: a Contribution to the Theory of Curative Springs,' *Wochenblatt der Zeitschr. der k. k. Gesellschaft der Aerzte in Wien*, 1866, Nos. 34, 35, and 36.—Weber: 'Some Observations on the Application and Effects of Compressed Air,' *Memorabilia; Monatsblätter für prakt. u. wissenschaftl. Mittheilungen rationeller Aerzte*, 1866, eleventh year, No. 6, July 14.—A. Brünniche: *Beretning om A. Rasmussens medico-pneumatiske Anstalt i. 1866.* Kjöbenhavn, 1867 (sep. impression from *Bibliothek für Laeger*).—R. v. Vivenot: 'On Treatment by Air Pressure,' *Zeitschrift der 'Cursalen.'* Vienna, 1867, Nos. 6 and 7.—O. Th. Sandahl: *Des Bains d'Air Comprimé: Court Aperçu de leurs Effets Physiologiques et Thérapeutiques, précédé d'une Description de l'Etablissement Médico-pneumatique de Stockholm.* Stockholm, 1867.—H. Weber: *On the Influence of Alpine Climates on Pulmonary Consumption.* London, 1867.—G. v. Liebig: 'The Pneumatic Apparatus at Reichenhall, and other Signs of Progress at the above Health Resort, 1867,' *Bayer. ärztl. Intelligenzbl.*, No. 16.—Freud: 'Experiences on the Application of Compressed Air,' *Wiener med. Presse*, 1867, Nos. 11, 12, 18-25.—Vincent Brodowski: *Gazeta Lekarska*, 1867, Nos. 17, 18-45.—R. v. Vivenot: *Contributions to Pneumatic Respiratory Therapeutics.* Vienna, 1868 (separate impression *Allg. Wien. med. Zeitung*, 1868).—R. v. Vivenot, jun.: *On the Physiological Effects and the Therapeutic Employment of Condensed Air.* Erlangen, Ferd. Enke, 1868.—Panum: 'On the Physiological Effects of Compressed Air,' *Pflüger's Archiv der Phys.*, 1868, i. 2, 3.—G. v. Liebig: 'The Pneumatic Apparatus at Reichenhall during 1867,' *ibid.* 1868.—Runge: 'On the Theory of the Influence of Compressed Air (Artificially increased Pressure of Air) on the Organism,' *Wiener allg. med. Zeit.*, 1868, 12, 13.—E. Levinstein: 'Cases of the Employment of Compressed Air with Pulmonary Patients,' *Kisch. Balneol. Zeitung*, 1868, ii.—Pundschu: 'On the Pneumatic Apparatus as a Remedy for Chest Disease, observed at Reichenhall,' *Wiener med. Presse*, 48, 49, 1868.—R. v. Vivenot: 'Contributions to the Theory of Pneumatic Respiration,' Vienna, 1868, 4, 16 pp., *Allg. Wiener med. Zeitung*, 1868.—G. v. Liebig: 'On the Effect of Mountain Air on the Organism,' *Bayer. ärztl. Intelligenzbl.*, 1869, No. 16.—Id.: 'On Respiration under Increased Air Pressure,' *Zeitschr. für Biologie*, 1869, v. i. 1.—C. W. Müller: 'On the Vital Capacity,' *Zeitschr. für rationelle Med.*, xxxiii. 1869.—L. Coindet: *Le Menique, considéré au Point de Vue Médico-chirurg.* Paris, 1869.—Pr. Lortet: *Recherches Physiologiques sur le Mal des Montagnes.* Paris, 1869.—H. Weber: *On the Treatment of Phthisis by Prolonged Residence in Elevated Regions.* London, 1869.—Pr. de Pietra-Santa: *Union Médicale*, 1863, et *Annal. d'Hygiène*, 1869.—G. v. Liebig: *Investigations upon the Ventilation and Warming of the Pneumatic Chamber from the Medical Point of View, Conducted at the Pneumatic Apparatus of Mack Brothers at Reichenhall*, with 1 woodcut and 1 register. Munich, 1869, R. Oldenburg.—Id.

'Asthma in Pulmonary Emphysema, Improvement by means of Increased Air Pressure,' *Bayer. ärztl. Intelligenzbl.*, 1870, 26.—J. Lange: *On Substantive Pulmonary Emphysema and its Treatment with Compressed Air*. Dresden, 1870.—G. Lange: 'On the Treatment of Chronic Pulmonary Phthisis,' *Memorabilia*, xv. 1, 2, 1870.—Gent: 'On the Therapeutic Employment of Compressed Air in Asthma and Emphysema,' *Bull. de l'Académie Française*, xxxiv. p. 119, December 15, 1870.—R. v. Vivenot, jun.: 'Therapeutic Employment of Artificially Changed Air Pressure,' *Wiener med. Presse*, xi. 23, 27, 1870.—Freud: 'On Tussis Convulsiva and its Treatment by Means of the Pneumatic Apparatus,' *Oesterr. Zeitschr. für prakt. Heilkunde*, xvi. 25, 26, 1870.—L. Bauer: 'Dangerous Effects of Highly Raised Air Pressure on the Brain and Spinal Cord in Human Beings,' *The St. Louis Medical and Surgical Journal*, vol. vii. (No. 5, iii.), No. 3, p. 235. May 1870.—Marc: 'Contributions to the Theory of the Physiological and Therapeutic Effects of Baths of Compressed Air,' *Berliner klin. Wochenschr.*, 1871, viii. 21.—P. Bert: 'Recherches expérimentales sur l'Influence que les Changements dans la Pression Barométrique exercent sur les Phénomènes de la Vie,' *Compt. Rend.*, tome lxxiii. pp. 213, 503; tome lxxv. pp. 491, 543; tome lxxvi. p. 1493; tome lxxviii. p. 111.—G. v. Liebig: 'On the Influence of Changes of Air Pressure on the Human Body,' *Archiv für klin. Medic.*, viii. 5 and 6, 446-466, 1871.—A. Buchanan: 'On the Influence of Atmospheric Pressure on the Circulation of the Blood,' *Report of the Forty-first Meeting of the British Association for the Advancement of Science*, held at Edinburgh, August 1871. London, John Murray, 8.—Michaelis: 'Lecture on the Effects of Increased and Diminished Air Pressure on the Human Body,' *Report of the Session of the Society of Natural Science 'Isis' at Dresden*, 1872, No. 1.—Freud: 'Communications from the Pneumatic Sanatory Institute at the Sophiabad, Vienna,' *Wiener med. Wochenschr.*, 1872, 17, 18, 40.—G. v. Liebig: 'The Effect of Increased Air Pressure in the Pneumatic Chamber on Human Beings,' *Deutsche Klinik*, 1872, Nos. 21 and 22.—Id.: 'On the Circulation of Blood in the Lungs and its Relations to Air Pressure,' *Deutsches Archiv für klin. Medicin*, x. 1872 (separate impression).—Waldenburg: *Local Treatment of Diseases of the Respiratory Organs*. 2nd ed. Berlin, 1872.—H. Masius: *Aërial Journeys of F. Glaisher, Flanmarion, Fonvielle, and G. Tissandier*. Leipzig, 1872.—A. Göschen: 'The Pneumatic Chamber at Reichenhall,' *Deutsche Klinik*, 1873, i.—Simonoff: 'On the Effects of Condensed Air on the Respiratory Organs,' *Petersburger med. Zeitschr.*, new series, iii. 3, p. 269, 1873.—Canuet: 'Asthma Cured by Condensed Air,' *Gaz. de Paris*, 16, p. 216, 1873.—J. A. Fontaine: *Nouveaux Appareils Pneumatiques pour administrer le Bain d'Air Comprimé*, Communication à la Section de Médecine de l'Association Française pour l'Avancement des Sciences (Congrès de Bordeaux), 1874, 4 pl. 16 pp.—G. v. Liebig: 'The Exchange of Gases in the Lungs under Increased Air Pressure in the Pneumatic Chamber,' *Bayer. ärztl. Intelligenzbl.*, 1874.—G. Lange: 'The Pneumatic Cabinet and the Transportable Pneumatic Apparatus,' *Allgem. med. Centralzeit.*, xliii. 28, 29, 30, 1874.—Labadie-

Lagrave: 'Aérothérapie, &c.,' *Gaz. Hebdomad. de Paris*, 7, 8, 1874.—  
 Guichard: 'Observations during Residence in Compressed Air, and in  
 Various Deleterious, Stupefying, and Explosive Gases,' *Journal de  
 l'Anatomie et de la Physiol.*, 1875, No. 5, Sept. and Oct.—D. Jourdanet:  
*Influence de la Pression de l'Air sur la Vie de l'Homme: Climats d'Altitude  
 et Climats de Montagne*. Paris, 1875.—J. Pircher: 'The Pneumatic  
 Apparatus at Meran,' *Vierteljahrsschrift für Klimatologie von Reimer und  
 Siegmund*, vol. i. 1875.—G. v. Liebig: 'The Employment of the Increased  
 Air Pressure of the Pneumatic Chamber Therapeutically,' *Wiener med.  
 Wochenschr.*, 1875, Nos. 23 and 24.—Id.: 'On the Absorption of Oxygen  
 in the Lungs under Ordinary and Increased Air Pressure,' *Pflüger's Archiv*,  
 1875, vol. x. Nos. 10 and 11.—Simonoff: 'On the Influence of Condensed  
 Air upon the General Nutrition of the Body,' *Petersburg. med. Zeitschr.*,  
 new series, vol. iii. p. 258, 1875.—J. C. Pravaz: *Recherches expéri-  
 mentales sur les Effets Physiologiques de l'Augmentation de la Pression  
 Atmosphérique*. Paris, G. Masson, 1875, 8, p. 66.—C. Forlanini:  
 'Brevissimi Cenni sull' Aëroterapia e sullo Stabilimento medico-pneu-  
 matico di Milano,' *Gaz. Lomb.*, xxxv. 47, 49, 50, 51, 1875.—Josephson:  
*On Professor Waldenburg: Comparison of the Pneumatic Cabinet with  
 the Transportable Pneumatic Apparatus*. Hamburg, 1875, C. E. Nolte,  
 No. 8, 26 pp.—Sieffermann: 'Climatology and Aërotherapeutics: Critical  
 Exposition,' *Gaz. Méd. de Strasbourg*, No. 10, Oct. 1, 1875.—Simonoff:  
*Aérothérapie*, with four woodcuts. Giessen, 1876, J. Ricker.—Pircher:  
 'Expiration from the Pneumatic Cabinet into Free Atmospheric and Rare-  
 fied Air, and Treatment of Pulmonary Emphysema,' *Wiener med. Presse*,  
 35, 36, 1876.—Stembo: *Contributions to the Physiological Influence of Com-  
 pressed Air*, Inaug. Dissert. Berlin, 1877.—Schyrmunski: *On the Influence  
 of Rarefied Air upon the Human Organism*, Inaug. Dissert. Berlin, 1877.  
 —G. Lange: 'Communications on the Action of the Transportable Pneu-  
 matic Apparatus,' *Deutsche med. Wochenschr.*, 37, 1877.—F. Hoppe-Seyler:  
*Physiologische Chemie*, part i. p. 13, 1877, and part iii.—H. Jakobson and  
 Lazarus: 'On the Influence of Residence in Compressed Air on Blood  
 Pressure,' *Centralblatt für die med. Wissensch.* No. 51, 1877.—G. Lange:  
 'Therapeutic Observations on the Action of the Transportable Pneumatic  
 Apparatus and of the Pneumatic Cabinet,' *Deutsche med. Wochenschr.*, 51,  
 52, 1877.—Solomka: 'The Treatment of Diseases of the Respiratory  
 Organs with Compressed Air,' *Petersb. med. Wochenschr.*, 26, 1877.—  
 Knauer: 'On the Influence of Residence in Rarefied Air on the Form of the  
 Pulse Curve,' Inaug. Dissert. Berlin, 1878.—P. Bert: *La Pression Baro-  
 métrique: Recherches de Physiologie Expérimentales*. Paris, 1878, Masson.—  
 Neukomm: 'The Pneumatic Cabinet and the Transportable Pneumatic  
 Apparatus,' *Schweizer Corr.-Bl.*, viii. 1878.—W. Marcet: 'Experiments on  
 Respiration at Different Altitudes,' *Arch. des Sciences Physiques et Natu-  
 relles*, lxxii. 246, Juin 1878; *Annual Register*, clxxxii. p. 240.—G. v.  
 Liebig: 'The Pneumatic Cabinets of Reichenhall, their Results in Asth-  
 matic Catarrhs and Emphysema,' *Deutsche med. Wochenschr.*, 24, 25, 1879.—  
 W. Marcet: 'Experiments on Respiration at Different Heights on the Island

and the Peak of Teneriffe,' *Proceedings of the Royal Society of London*, xxviii. p. 498 (No. 195), April 1879.—E. Leyden: 'On the Affection of the Spinal Cord caused by Sudden Diminution of Barometric Pressure,' *Arch. f. Psychiatrie u. Nervenkrankheiten*, ix. 2, p. 316, 1879.—Fr. Schultze: 'On the Affections of the Spinal Cord set up after the Influence of suddenly Lowered Air Pressure,' *Virch. Arch.*, lxxix. p. 124, 1879.—G. v. Liebig: 'An Apparatus for Illustrating the Pressure of Air on the Respiration,' *Arch. f. Anat. u. Physiolog.*, 3 and 4, p. 284, 1879.—S. Hadra: 'Influence of Compressed Air on the Quantity of Urea in the Human Subject,' *Zeitschr. für klin. Med.*, i. 1, p. 109, 1879.—Waldenburg: '*Pneumatic Treatment of Respiratory and Circulatory Affections*, &c. Berlin, 1880, A. Hirschwald.—G. v. Liebig: 'The Pnoometer,' *Deutsche med. Wochenschr.* vi. 22, 1880.—A. Fränkel: 'On the Influence of Condensed and Rarefied Air upon the Change of Matter,' *Zeitschr. für klin. Med.*, ii. No. 1, 1880.—Rossbach: *Lehrbuch der physikalischen Heilmethoden*. Berlin, 1881, A. Hirschwald.

---

## A. CONDENSED AIR.

### PNEUMATIC CHAMBERS (BELLS, CABINETS).

IN order to cause air of different degrees of density to act not only on the pulmonary surface, but also on the whole body, we require apparatus into which the patients can be received and where they can remain for a long time.

The diving-bell served as a model for their construction, and Tabarié's apparatus has in part adopted its shape; the French still term these apparatus *cloches pneumatiques*. At present the pneumatic chamber differs considerably from its original form; instead of being composed of plates of wrought sheet-iron joined together, a complete structure of brick has been introduced by Simonoff. Although we should not lose sight of the principle that rarefied as well as condensed air is valuable for its mechanical and physiological effects on the diseased organism, yet at present pneumatic apparatus are chiefly adapted for the use of condensed air, as when rarefied air seems indicated it is thought best to avail oneself of the natural diminution of air pressure provided in the numerous elevated health-resorts. In Lange's apparatus, however, at Johannisberg the air in the cylindrical space could also be rarefied, and positive and negative degrees of pressure could be

used at pleasure. The same is the case with the pneumatic chamber in the Jewish Hospital at Berlin. Lastly, Neukomm has quite recently used rarefied air in the pneumatic chamber at Zürich, and in the case of emphysematous and asthmatic cases with favourable results.

#### CONSTRUCTION OF THE PNEUMATIC CHAMBERS.

##### 1. *Tabarié's Apparatus.*

Tabarié's apparatus, constructed on the principle of the diving-bell, is in the form of a hollow ellipsoid, whose long diameter is vertical and its short horizontal. The lower third of the ellipsoid is sunk into the earth and separated from the upper part by a wooden floor on a level with the ground, so that the apparatus exactly resembles a large bell, and is capable of containing 4 to 12 persons. The floor of the apparatus is perforated with numerous orifices, by means of which the air of the two bell spaces communicates, while carpets conceal them from the eye and 4 to 12 chairs placed round the table in the centre are ready for the persons who are to take their sittings in the apparatus.

The bell itself is constructed of wrought sheet-iron, the thickness of which is capable of bearing a pressure three times as great as that applied. The walls are lined internally with padded silk or leather and furnished with one or more windows of glass an inch thick, which are riveted into special iron cylinders in the curved walls of the bell, that the panes of glass may not be exposed to any curvature, and thus be preserved from cracking. The door, opening inwardly, is surrounded with an indiarubber rim, and so exactly fitted-in that it is hermetically closed by the air pressure.

An antechamber in communication with the entrance of the apparatus, closing spontaneously by a valve (fig. 78), permits ingress and egress, without any material change of the air pressure in the apparatus. A niche introduced into the wall, closing by a valve, serves for conveying small objects in and out. A bell-pull admits of communication with the persons outside the apparatus, the physician, mechanics, &c. There is also a thermometer inside Tabarié's apparatus, to deter-

mine the temperature of the air in the bell, and also a metal or mercury manometer, which allows the increase and decrease of air pressure to be read off on a scale. In other apparatus constructed on the principle of Tabarié's the manometer is placed outside and communicates with a tube soldered in the wall. A psychrometer is also added now, to determine the amount of moisture in the air.

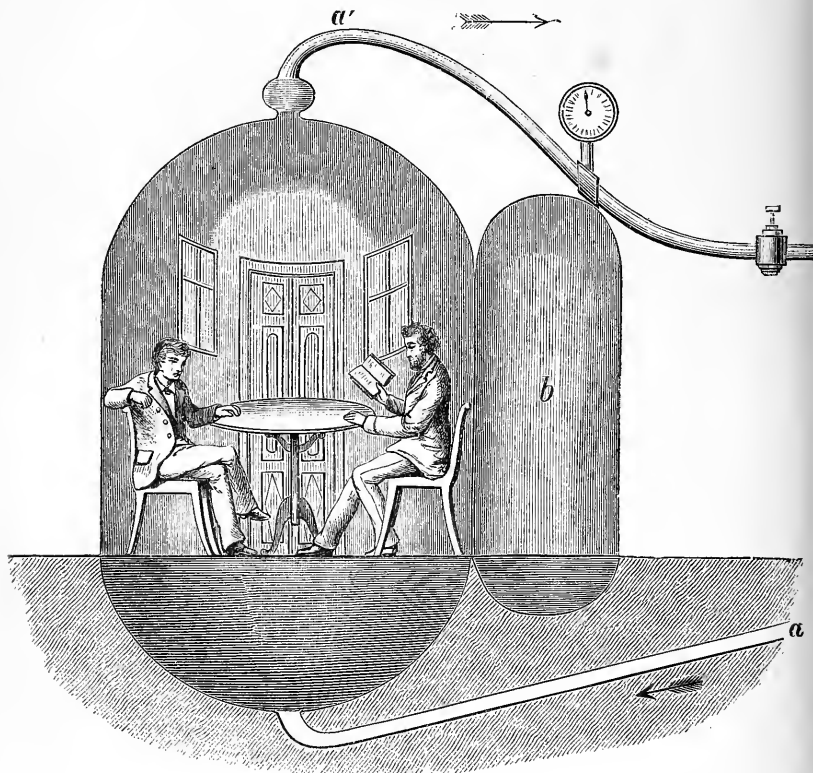

FIG. 78.

Fresh air, taken from a suitably selected place and filtered through cotton wool, is continuously pumped into the apparatus, (schematically represented in fig. 78,) by means of a steam engine through a tube (*a*, fig. 78) communicating with the lower extremity of the apparatus, whence it makes its way through the perforated wooden floor into the chamber, and passes again into the open air through an outlet tube (*a'*) inserted in the opposite end.

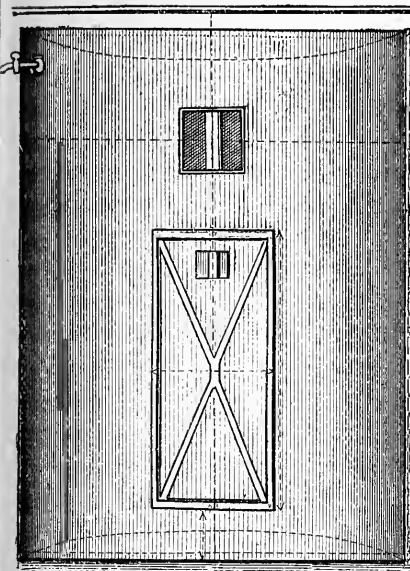

FIG. 79.

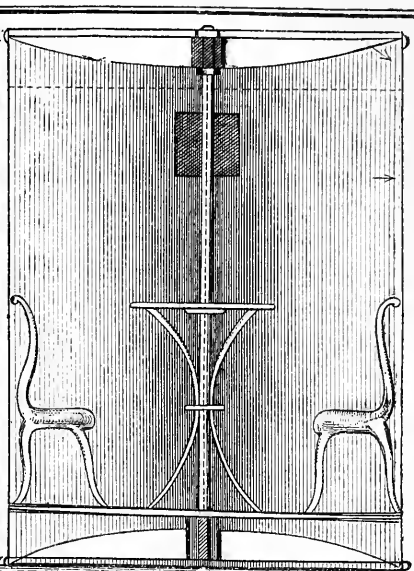

FIG. 82.

FIG. 80.

FIG. 83.

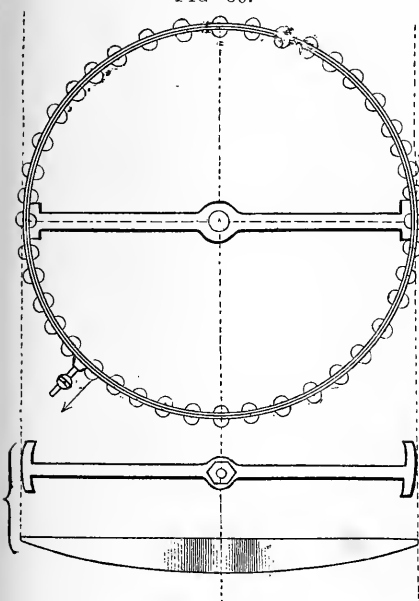

FIG. 81.

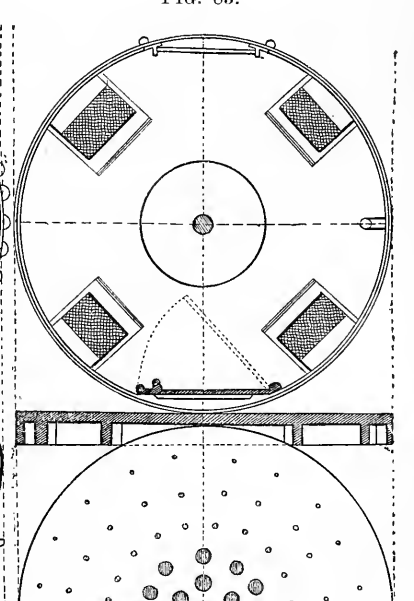

FIG. 84.

The pump conveying the air is a double-action air pump, with two boilers which are so constructed that while the one is emptied the other fills, thus allowing a uniform supply of air. In order to be able to regulate at pleasure the pressure within the bell, the inlet and outlet tubes are furnished with means to increase the afflux and efflux of air. If a gradual elevation of air pressure is desired, the outlet orifice is narrowed, so that less air flows out at  $a'$  than that which flows in at  $a$ . If a constant elevation of pressure is to be maintained, then let the same quantity of air flow off at  $a'$  as that which enters at  $a$ . Any possible excess of the desired maximum pressure is checked by a safety valve, which is raised when the pressure increases, and thus equalises it again.

The apparatus at Montpellier, Lyons, Nice, London, Stockholm, Stuttgart, and St. Petersburg have been constructed on the plan of Tabarié's apparatus.

## 2. *G. Lange's Apparatus (v. Vivenot).*

In form and construction it differs somewhat from Tabarié's, and was first set up at Johannisberg, afterwards at Ems; in it v. Vivenot carried out the chief of his laborious investigations. Lange's principal aim was to diminish the expense by simplifying the construction, as well as to introduce improvements in the ventilation, the warming, and the cooling of the air in the apparatus.

Weighing the circumstances to be taken into consideration, Lange gave his apparatus a cylindrical instead of an ellipsoid form, closed at top and bottom by two iron plates convex internally. The latter are secured by an iron bar running through the centre of the cylinder, at the upper and lower end of which an iron transverse band is screwed on. The drawing in fig. 79 gives the front view thirty-six times reduced, fig. 80 the ground plan, fig. 81 the transverse band, fig. 82 the longitudinal section, fig. 83 the transverse diameter, fig. 84 the perforated wooden floor of the apparatus, whose dimensions had to be adapted to the space available in the establishment, and which therefore was only capable of containing four persons. Its vertical diameter is eight feet, the transverse diameter six feet, the



circumference of the cylinder nineteen feet, the cubic capacity of the chamber 226·08 cubic feet. Sheet iron  $\frac{3}{16}$  of an inch thick was used for the construction of the cylinder, sheet iron  $\frac{1}{4}$  inch thick for the vaulted cupolas; the iron bars running through vertically were an inch thick, the glass window  $\frac{3}{4}$  to 1 inch in thickness. The double-action air pump, which drives the previously filtered air taken out of an open space into the apparatus, has six inches (15·70 centimetres) piston diameter and nine inches (23·50 centimetres) piston lift; consequently its base is reckoned according to the formula  $v^2 \cdot \pi = 193 \cdot 43$  cubic centimetres, and its cubic capacity at 4,547 cubic centimetres. As the air pump has double action, therefore, without taking into calculation some unavoidable loss, 9,094 cubic centimetres of air with one lift of the piston, and with slow action, with 20 lifts to the minute, 181,088 cubic centimetres of air are conveyed into the pneumatic apparatus. The machine can, going moderately, make 30 lifts in the minute, in which it conveys somewhat over 15 cubic feet of air in the minute. The cubic capacity of the apparatus, 226 cubic feet, divided by the latter number (15), allows the air in the apparatus to be completely renewed in 15 minutes with 30 lifts of the double-action pump. Now v. Vivenot calculates one respiration at 700 cubic centimetres, therefore 20 respirations at 14,000 cubic centimetres, so that thus four persons would use 56,000 cubic centimetres of air, i.e. the third part of the air which the steam engine is capable of conveying to them with slow action. G. v. Liebig has, however, proved that this calculation is inaccurate and that a far larger supply is necessary, if not only sufficient air for the respiratory process is to be provided in the apparatus, but also fresh, pure air as free from expiratory products as possible, with the due proportion of carbonic acid (0·1 per cent. according to Pettenkofer), such as is necessary for healthy, well-ventilated dwelling-spaces.

While the regulation of the pressure, the conveyance and the removal of air is the same in Lange's as in Tabarié's apparatus, and the internal construction is also the same, Lange has also introduced into his apparatus a regulator which prevents the jerky entrance of the air, and another contrivance by which, in case of necessity, the compressed air may be impreg-

nated with vapourised medicinal substances, such as pine-cone oil, &c.

Lange uses two methods for lowering the possibly too high temperature in the chamber—first, cooling the air before it penetrates into the chamber, by applying cold water of 12° R. to the air pump and the conducting pipes; and secondly, conducting cold water into the dish-like space in the upper surface of the apparatus, whence it may, if necessary, flow off through small closable orifices also on the outer lateral walls of the apparatus, where it is soaked up by large pieces of linen hung there and evaporated. The warming of the air in the apparatus during the cold season is effected by heating the room in which it stands.

Lastly, Lange devised another contrivance by which the air in the apparatus can not only be condensed but also rarefied by means of a slight alteration in the air pump. If the latter is desired, the door on the outer side must be opened, i.e. hung in the opposite way, so that it may be hermetically closed by the outward pressure, now the stronger. G. Lange's apparatus, like that of Tabarié, served as a model for most of the apparatus used at that time in Germany, e.g. at Neuschöneberg, Berlin, Vienna, Hanover, Wiesbaden, and other places.

### 3. *Apparatus of G. v. Liebig at Reichenhall.*

The pneumatic chamber built by G. v. Liebig at Reichenhall differs from those previously constructed in very essential points, the alterations remedying a number of considerable defects and disturbances which had existed in all preceding apparatus and which interfered with their general therapeutic utility. Improvements were effected not only in the form and space of the construction, but especially in the mode of ventilation, the warming and cooling of the air in the rooms, owing to which the Reichenhall chamber (property of the brothers Mack) is found to be now that which best satisfies the physico-physiological and therapeutic demands (fig. 85).

As regards these improvements individually, the apparatus deviates from all previous apparatus—

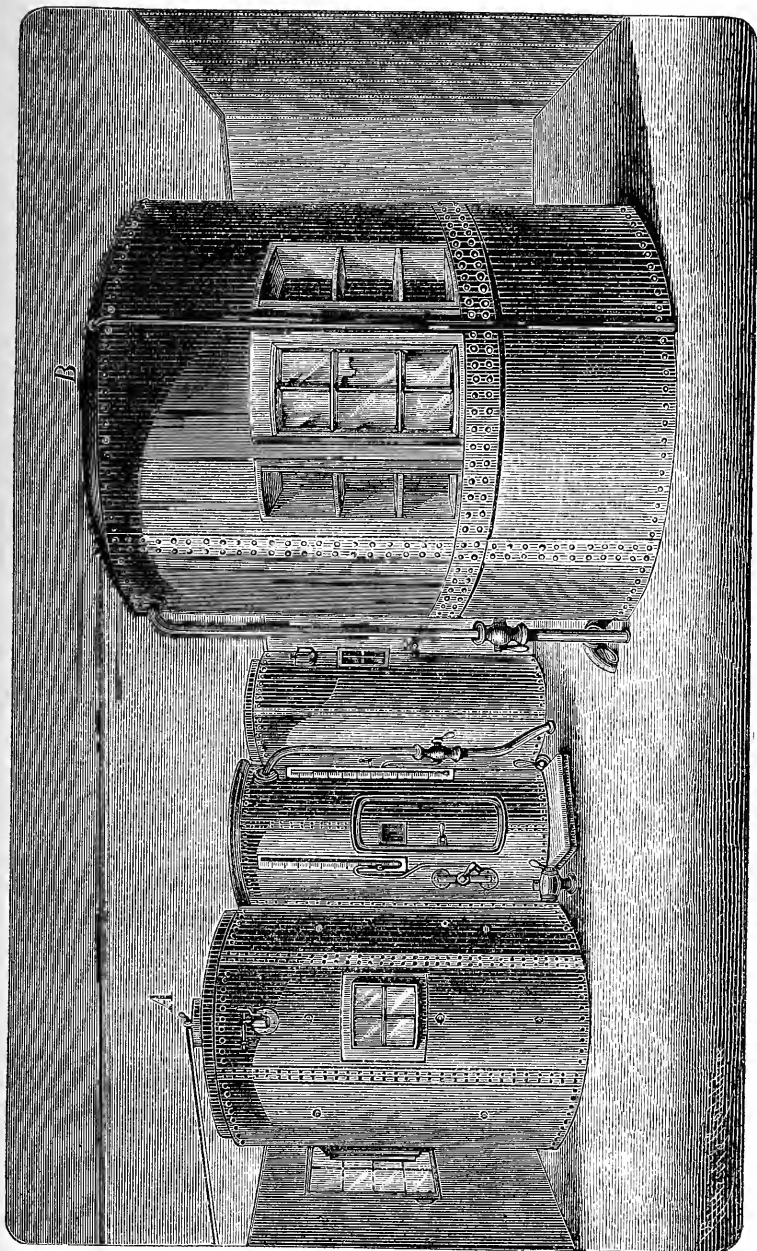

FIG. 85.

(1) *In Form and Space,*

as it forms a combination of three equally large rooms of sheet iron, two of which lie close to the third central one and communicate by means of an antechamber. Space for the anteroom is obtained by enclosing the free space outside and between the three chambers by a wall containing the door by which the antechamber is entered. The three other walls of the antechamber are formed by the walls of the three chambers themselves, which are entered by doors from the antechamber. Each room, amply lighted by three windows of thick glass, is 2·33 metres high, 2·04 metres in diameter; thus it has a base of 3·276 cubic metres and a capacity of 7·651 cubic centimetres; so that three persons can sit round a table in each of them, and consequently nine persons together can be accommodated in the whole apparatus. The antechamber is much smaller; its average width is 1 metre, its depth 1·3 metre, and it is at the same time somewhat less high than the chambers.

(2) *The Inflow of Air*

is produced by an air pump which stands in another room and is set in motion by a steam engine. The engine, sucking in the air through a wide tin pipe, first drives it into a small external reservoir, and thence into an iron pipe 44 centimetres long, one end of which is directly connected with the regulator, while the other communicates with two iron tubes each 7 centimetres in diameter and 29 metres in length. These two tubes run underground parallel with one another at some distance, and when they reach the apparatus enter it at each side of the door of the antechamber. Before their entrance each tube is furnished with a stopcock. As the wooden floor of the antechamber as well as the carpeted floor of the chamber is perforated, and there is an orifice also under the floor in the wall which separates the chamber from the antechamber, therefore the air enters the chamber from the antechamber through the orifices of the wooden floor and through the pierced chamber walls, so that the antechamber at once serves as a great regulator of the pressure in the chamber and prevents the patient's feeling the jerky penetration of the air. The passage of the

air out of the chamber occurs through orifices above, near the ceiling, closed by gratings, to which the outlet pipes, furnished with regulating cocks, are affixed. By placing a cloth at the entrance of the external outlet pipes the sounds attending the efflux of air are silenced. A mercury manometer, with millimetre divisions for determining the air pressure in the chambers, is placed outside near the door in communication with the antechamber, while within and near the window of the single chamber an August's psychrometer shows the temperature and the amount of moisture in the air. The double-action air pump yields with every lift 27·3 litres of air, and the piston moves up and down somewhat over 140 times in the minute, so that constantly an overplus of air streams into the chambers and an uniform regulation is brought about each time by an assistant who stands at the antechamber and observes manometer and psychrometer.

The difference therefore between the regulation of pressure in the Reichenhall apparatus and that previously used is, that here the increase of pressure is produced by increasing the afflux, not, as in the other apparatus, by arresting the efflux. By this mode only can we obtain satisfactory ventilation.

(3) *For Regulating the Temperature, the Warming and Cooling of the Air,*

V. Liebig uses the two feeding pipes which convey the in-streaming air and which communicate with each side of the door of the antechamber. The inflowing air is warmed in one pipe, cooled in the other. The one feeding pipe is warmed by the steam of the engine, which is conducted into a reservoir through which this pipe runs, while the necessary cooling of the air in the other pipe is obtained by passing it through a reservoir of water kept at the temperature desired. Besides this, in the apparatus at Reichenhall, as in that of Ems, cold air may be carried up to the roof, which has the same dish-like shape, and can trickle down thence through small orifices at the edge along the wall, and be rapidly evaporated by means of rough linen cloths. When these contrivances are properly managed, there is no difficulty whatever in not only creating any suitable temperature in the interior of the chamber, but also maintaining it at a sufficiently uniform rate for a very long time.

4. Lastly, Liebig has hit upon a contrivance by which a lower pressure may exist in one of the three chambers, while in the two others a more highly compressed air still remains. For this purpose he has brought the orifice which goes under the floor of the antechamber into this chamber, not directly into communication with the chamber, but has placed there a copper pipe about three centimetres wide, which runs under the floor of the antechamber and goes through its wall near the door towards the outside, entering the chamber about a foot above the place of exit. As the part of the pipe which is seen outside the antechamber is furnished with a cock by the turning of which the afflux of air is somewhat retarded, a pressure slighter than that in the other two chambers, as can be shown by the manometer, can be established in the chamber in question.

5. As an estimate for determining the ventilation and for controlling it, Liebig has adopted the percentage of carbonic acid in the air fixed by von Pettenkofer = 0.1 per cent. for well-ventilated inhabited rooms. As pure air containing 0.05 per cent. of carbonic acid is used for filling the apparatus, the air in the apparatus can absorb another half-volume of carbonic acid before it will contain 0.1. per cent. According to v. Pettenkofer one person expires in an hour 300 litres of air with 4 per cent. carbonic acid, i.e. 12 litres of carbonic acid. If now we desire to obtain air of only 1 per cent. carbonic acid in the apparatus we shall require to each  $\frac{1}{2}$  litre of carbonic acid of the expired air 1,000 litres of pure air, which must far exceed the amount of ventilation which Vivenot and Lange have assumed for their apparatus. The Reichenhall apparatus for controlling ventilation is tested every year  $1\frac{1}{2}$  hour after the commencement of the sitting; an estimation of the carbonic acid in the air of the apparatus is repeated for one and more persons and for each person, in order to find again the exact position of the outlet cock in which the proportion of carbonic acid in the air with 1, 2, or 3 persons in the chamber is normal. The points ascertained are noted on a scale on the cock. For the more convenient conduct of the chemical analysis small cocks are attached to the apparatus, by which the air may be drawn off at any time in any quantity desired.

In addition to the many-chambered apparatus a single-

chambered one for six persons, with similar construction and fittings, is now set up at Reichenhall.

Owing to the improvements introduced by V. Liebig in ventilation, cooling, and warming, as well as in the possibility of applying various degrees of pressure and the simplicity of the mechanism, the Reichenhall apparatus is now really a model, to be taken into consideration in the construction of new apparatus, whether single or many-chambered, according to need.

#### 4. *Simonoff's Apparatus at St. Petersburg.*

In Simonoff's establishment at St. Petersburg there are not only two iron, but there is also a stone apparatus, which consists of two rooms and is constructed on the same principle as the iron ones.

Simonoff's object in erecting it was to offer the greatest possible comfort to patients, and he was also influenced by the circumstance that a far more exact regulation of heat can be carried out in a stone building, on account of its being a bad conductor of heat, as, according to Despretz's experiments, brick conducts heat thirty-five times more slowly than iron.

The building in which the stone apparatus is to be placed is peculiarly constructed; it consists of two small rooms with thick walls, and is furnished with iron window and door frames instead of wooden ones. Seen from without, there is nothing to distinguish this building from the others. The inner room (fig. 86) differs from ordinary sitting-rooms only in its circular form, while its furniture is somewhat more elegant than usual. The patients are placed only in the back larger compartment; in the front one there is an iron stove, also a water closet which the patients can use while remaining in condensed air. A speaking-tube and a system of electric signals also facilitate easy communication between physician and patient. By means of a double door the patient can at any time leave the apparatus and the physician enter it, without in the least altering the condensation of the air, consequently without even for a moment interrupting its action on the patients remaining behind in the apparatus.

In this same way the stone apparatus, furnished with all conveniences and with the means of easy communication with

the outer world, might in case of necessity be used for long residence, even for several days, if hereafter indications should arise for such persistence in pneumatic treatment.

Dr. S. A. Fontaine a short time ago described a new apparatus which only differs from the preceding in the circumstance that the compression of air is effected by natural water pressure instead of steam. For this purpose some alterations in the mechanical arrangements of the apparatus are necessary, while the outlay for the compression of air is considerably diminished.

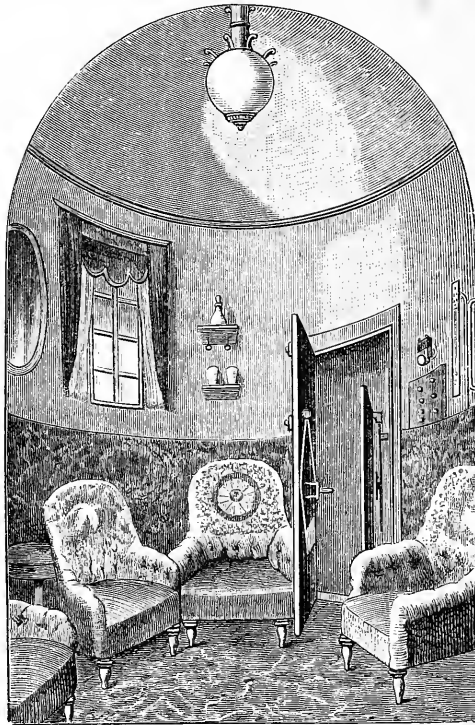

FIG. 86.

#### MANAGEMENT AND USE OF THE PNEUMATIC CHAMBERS.

The technical management of the sittings in the pneumatic chambers is entrusted to an experienced man who is familiar with the construction and the mode of action of the apparatus and with the physical principles on which the treatment is



founded. It is his duty to observe and to regulate, according to special medical prescriptions and the general estimates given, the conditions of pressure in the apparatus, the increase of pressure, the height at which it is to be constantly maintained, and its decrease, and to look to the temperature in the apparatus and the amount of moisture in the air, and to put an immediate stop to disturbing changes.

The physician's duty is, after fixing the indications in the special case, to determine the number and course of the individual sittings and any possible alteration in their usual form, especially as to the duration and the amount of pressure to be applied, which must be adapted to the nature of the malady, the state of the patient, and the progressive improvement. The amount of excess pressure, the length of the sitting, and the period of treatment are exclusively subordinate to medical orders and control, and the mechanician or the experienced man in charge of the apparatus simply carries out the physician's directions.

Most conductors of pneumatic sanatory institutions are in the habit of establishing once for all, and maintaining unaltered, a certain excess pressure amounting to  $\frac{2}{3}$  to  $\frac{3}{4}$  atmosphere, according to Tabarié's suggestion. Nevertheless, according to the therapeutic observations which have been made in the employment of increased air pressure in the pneumatic chamber, some more definite indications may be formulated as to the amount of excess pressure that may be used.

1. The application of an excess pressure exceeding that of  $\frac{1}{2}$  atmosphere = 38 centimetres mercury, according to the observations made in cases kept under supervision for a long period, with regard to the acceleration of the oxidising process and of the tissue change, yields no better results, and in some instances even less satisfactory ones, than those which can be obtained by a comparatively low excess pressure. Only in cases of obesity, in order if possible to promote the oxidising process in the body, as in meteorism, constrictions, asphyxia, in which the object is to obtain the immediate mechanico-chemical effect of condensed air, and not to follow a protracted course of treatment, this excess pressure may appear admissible; in other cases it is of no use.

2. In well-nourished individuals of strong constitution and middle age, not reduced in strength, an excess pressure of  $\frac{2}{3}$  to  $\frac{3}{7}$  atmosphere = 30 to 32 centimetres mercury, such as is generally employed for therapeutic purposes, will act most effectually.

3. On the other hand, for weakly patients only a small excess pressure of about  $\frac{1}{3}$  atmosphere = 15.2 centimetres mercury may be well borne, and it will be safer to keep to this till their strength gradually increases, and then slowly pass on to higher pressure.

4. Very feeble patients, reduced by chronic exhausting illnesses and suffering from fever, are not fit subjects for the use of compressed air, as it would only hasten the consumption of their strength. On the other hand, feverish symptoms occurring in acute diseases in the case of strong, previously healthy individuals do not counterindicate pneumatic treatment.

The transition from the normal atmospheric pressure to the predetermined excess of pressure, and conversely the return from the latter to atmospheric pressure, must be managed so gradually that the organism may accommodate itself to the new state of equilibrium corresponding to the change of pressure without being subjected to injurious disturbances. Too short a time, therefore, must not be apportioned to this transition; for on the conscientious fulfilment of this fundamental condition the possibility of a therapeutic employment of condensed air is entirely dependent, and to neglect it is to disregard all the conditions to which the result of the treatment is usually due. When the excess pressure has reached the intended height it must be maintained there unchanged for a long time, as it is only the prolonged and constant influence of this new pressure condition that can produce a certain constancy in the effects of pressure, which may persist beyond the period passed in the pneumatic chamber.

This object will be most completely fulfilled by a two hours' sitting with the usual excess pressure of thirty centimetres, the first and last half-hour being the transition stages, the intermediate hour the time of constant excess of pressure. If a higher excess pressure is desired, the duration of the transition stages must be prolonged accordingly; if a lower excess pressure, there may be a proportional abbreviation of the transition

stages. To accurately measure the time of the transition stage we may remember that the space of one minute must be counted for each centimetre difference of pressure; consequently the transition stage is to last as many minutes as there are centimetres excess pressure.

The one hour's duration of the stage of constant excess of pressure has also been empirically determined, so that it is neither necessary nor desirable to shorten the time of the sitting at the cost of this, and when it may perhaps be desirable to avoid too active combustion this object will be better attained by a corresponding diminution of the excess pressure. But also the prolongation of the stage of constant excess of pressure beyond this time should be only exceptionally ventured upon in cases of obesity during a long course of treatment in which it is desired to induce a more than normal activity in the processes of combustion in the organism. In such cases it is better to lengthen the sitting with an excess pressure of  $\frac{3}{7}$  atmosphere than to shorten the sitting with  $\frac{3}{4}$  atmosphere excess pressure.

Lastly, in cases of heart disease and of individual predisposition to congestions and hæmorrhages special caution is particularly needed in the transition stages, more especially the stage of decreasing pressure, which should be prolonged beyond the usual time. On the other hand, in cases of deafness arising from catarrh of the Eustachian tube a prolongation of the stage of increasing pressure corresponding to the circumstances has been frequently employed with advantage (cf. V. Vivenot).

As regards the duration of pneumatic treatment, it must always vary according to the nature of the disease, and be chiefly determined by the favourable effect of the sittings on the particular case; consequently the suggestion of an average duration of the treatment, to embrace the most heterogeneous pathological processes, can only be of very subordinate value.

Acute forms of disease, hyperæmias and catarrhal inflammations, are generally relieved in a short time, while chronic maladies of course require a much longer course of treatment. It is impossible to fix a number absolutely for these, as the duration of the treatment will require to be modified according to the nature of the complaint, the character of the different complications, and the constitutional idiosyncrasies of the indi-

vidual. In order that the effects obtained by frequently repeated submission to increased air pressure should gradually assume a permanent form, it is necessary at the beginning of pneumatic treatment to follow a two hours' sitting daily for some weeks in the pneumatic apparatus. On the other hand, in the later course of the treatment, especially if the effects of pressure on the respiratory apparatus after a few weeks begin to become habitual, short interruptions may be permitted without injurious consequences, so that a sitting in compressed air renewed every two or three days may suffice to maintain the result obtained. During a prolonged course of treatment Bertin even thought it better to allow short pauses, sometimes extending over several days, to intervene from time to time, as pneumatic treatment is by no means an indifferent thing, and under certain circumstances in the case of individuals enfeebled by age or reduced in strength disturbances of nutrition may be set up by too long continued uninterrupted influence of an excess pressure of  $\frac{2}{5}$  to  $\frac{3}{7}$  atmosphere, such as are observed in a much shorter time under a higher pressure of  $\frac{1}{2}$  atmosphere.

The following are the signs which should be taken as indicating the propriety of closing pneumatic treatment or intermitting it for a long time: a disproportionally increased organic combustion, considerable emaciation and steadily advancing decrease of weight, morbidly increased hunger, which finally ends in total loss of appetite, marked lassitude and muscular weakness, especially when these symptoms do not yield to the reduction of excess pressure or decrease in the number of pneumatic sittings. The patient has now overstepped the stage which has been described by Foley, in the case of workmen who are employed under increased atmosphere pressure, as the stage of gain, and has entered upon the stage of organic loss. If the pneumatic treatment cannot then be definitively closed, and if the pathological symptoms still require the further influence of increased air pressure, the sittings must be temporarily suspended till the disturbances resulting from augmented oxidation have been compensated.

We shall return to the approximate duration of pneumatic treatment in individual diseases in the section which treats of the special therapeutic application of increased air pressure.

Finally, as regards the interruption of the individual sittings, this can generally be managed by the patient himself, if any suddenly unforeseen accident should make it necessary to remove him from the chamber. It is certainly very rarely that disturbances in the apparatus or in the machine call for such an occurrence. As either a bell-pull or a system of electric signals and a speaking-tube is introduced into the apparatus, the patient can instantaneously attract the attention of persons outside the apparatus and obtain the necessary assistance, or he can pass out of it through the antechamber without altering the condensation of air in the apparatus. By the constant presence of a mechanician or some other experienced person during the sittings, disturbances on the part of the apparatus or the engine, or irregularities in pressure, too high a degree of heat in the chamber or too much moisture of the air can generally be set right by him without interrupting the sitting and without changing the compression of the air. The management and manipulation of the apparatus itself, as well as the use of the physical instruments in connection with it, must be learned practically, and presupposes a certain amount of physical and chemical knowledge. We cannot in this place give any theoretical instruction or special rules on this point.

#### PHYSICAL CHANGES OF THE AIR IN THE CHAMBER THROUGH INCREASE OF ATMOSPHERIC PRESSURE.

The air which is subjected to a higher pressure than that of the ordinary atmosphere in the pneumatic chamber undergoes definite changes in its physical properties, which must in the first place be taken into consideration in its application to therapeutic purposes.

As a larger volume of air becomes compressed into a smaller one, the latter not only contains the same proportions of oxygen and nitrogen, but all the other volatile substances which are also contained in it, and in the same relative proportion. In addition to small quantities of carbonic acid, and perhaps traces of other substances which may also be present in quite pure air, it is especially

*Aqueous Vapour.*

which is mixed with atmospheric air in greater or smaller quantities, and which in the condensation of air in the apparatus will exert important influence upon the physiological functions of the human organism within it. A given volume of air compressed by  $\frac{2}{3}$  to  $\frac{3}{7}$  atmosphere excess pressure to a smaller volume will contain the same quantity of aqueous vapour which was previously distributed over the larger volume, and thus the air in the apparatus will possess a higher degree of moisture than that of the atmospheric air.

Again, the air by the physical process of compression undergoes yet another change in its molecular constitution, which we must here take into consideration: it becomes warmer in proportion to the increase of pressure, and reaches the highest temperature at the moment of the highest pressure.

*The Rise of Temperature in the Air*

also influences its capacity for moisture, for by elevation of temperature it is able to absorb more moisture and thus become relatively drier. Hence the air in the apparatus, although its proportion of aqueous vapour, increased by condensation, has become absolutely greater, will nevertheless be still capable of absorbing more aqueous vapour without exceeding or even reaching the point of saturation. The increase of moisture in the apparatus due to the expiration of the patients within it will therefore, with increased pressure and raised temperature, be compensated by the increase of capacity for moisture in the air and lead to no special phenomena. It follows therefore that if the pressure is lowered and the density diminished, a gradual fall of temperature occurs, and the capacity of the air for moisture will immediately fall, so that the relative proportion of moisture in the air undergoes in the same ratio a progressive increase, and the air ultimately becomes over-saturated with aqueous vapour, which is gradually deposited.

According to the construction of pneumatic chambers and the contrivances for regulating the temperature and heating, these physical conditions will appear with more or less intensity

according as the chambers are empty or inhabited by several persons. Thus v. Vivenot observed in Lange's apparatus at Johannesburg, when it was not occupied, that the temperature of the air underwent a gradual increase as the pressure rose, and reached its highest point =  $+ 2.1^{\circ}$  R. when the pressure rose to =  $\frac{3}{7}$  atmosphere or 324.9 millimetres mercury, and from the moment when the stage of increasing pressure reached the highest point and passed into that of constant pressure sank again somewhat ( $+ 0.9$ ) and remained  $1^{\circ}$  R. above the temperature at starting. In the transition from condensation back to normal atmospheric pressure the temperature of the air began to fall again, assuming a lower position in returning to the normal pressure than at the first elevation; in two experiments of Vivenot's this reduction amounted to 0.5 and 0.4 R. Besides this, the more rapidly the transition to high or low pressure took place, the stronger was the rise or fall of temperature, so that fluctuations from  $5^{\circ}$  to  $6^{\circ}$  R. thus occurred.

When several persons occupied the pneumatic chamber some variations occurred with regard to the fluctuations of temperature during the different periods of pressure. As in the unoccupied chamber, the temperature rose with the increase of pressure up to the highest degree, and reached its maximum at the same time. According to v. Vivenot's observations this elevation with an excess pressure of  $\frac{3}{7}$  atmosphere amounted on an average to  $2.18$  R., according to Bertin with an excess pressure of  $\frac{2}{5}$  atmosphere on an average  $2$  R., so that the difference of the increase of temperature between the empty and the occupied room was considerable, and in general a slight amount of heat was given off by the persons present. On the other hand, whereas the temperature in the empty room was lower on the return to normal pressure than at starting, in the occupied room it was always higher than at the beginning of the sitting. V. Vivenot obtained on an average an excess of  $1.22^{\circ}$  R., which was to be attributed to the presence for two hours of the persons in it.

As regards the amount of moisture in the air in the empty pneumatic chamber, v. Vivenot found with increasing pressure only an increase in the absolute amount of vapour, while relatively the air was drier in comparison to the uniformly rising

temperature; when the pressure was maintained at constant height, the amount of moisture in the air was both absolutely and relatively higher than before; lastly, as the pressure decreased with simultaneous fall of temperature the aqueous vapour often increased even to the appearance of mist.

Examinations of the moisture contained in the air when the chamber was occupied showed important deviations from these observations. In this case the absolute and relative moisture increased steadily through all phases of pressure, so that the air at the beginning of the sitting was absolutely and relatively the driest, at the close of it absolutely and relatively the most moist. It is needless to say that the cause of this variation in the moisture was not due to the increased temperature of the chamber, but chiefly to the aqueous vapour given off from the skin and pulmonary surface of the persons inhabiting the chamber.

It is clear that in the construction of the pneumatic chamber these physical conditions must be fully taken into account, as not only its habitability but also the result of the treatment is essentially dependent on the removal of these disturbances. V. Vivenot performed his experiments in Lange's apparatus at Johannisberg, which was defectively ventilated and in size insufficient for the requirements of the persons present, and therefore obtained unsatisfactory results. In the Reichenhall apparatus, on the other hand, these drawbacks are entirely avoided, as is possible according to v. Liebig's construction, which provides for the admission of warm and cold air and for rapid alternations of stronger and weaker pressure within small limits during the increasing and ultimately decreasing pressure, and hence the unpleasant phenomena reported by various authors, such as feeling of oppression, general discomfort, breaking out of perspiration in the persons visiting the chamber, are no longer observed.<sup>1</sup>

All these troubles are due, on the one hand, to the abundant accumulation of carbonic acid and aqueous vapour as well as the consequent arrest of the discharge of moisture from skin

<sup>1</sup> Cf. G. v. Liebig, *Investigations as to the Ventilation and Warming of Pneumatic Chambers pursued from a Medical Point of View in the Pneumatic Apparatus of Mack Bros. at Reichenhall*. Munich, 1869, R. Oldenbourg.



and lungs, and on the other hand to the great fluctuations of temperature to which the patient was exposed in the chamber. With the removal of the causes these secondary phenomena are also entirely eliminated.

### ACTION OF INCREASED AIR PRESSURE ON THE ANIMAL BODY.

As the change of air pressure, and especially in this case air brought to a high degree of condensation in the chamber, does not, as when the transportable apparatus is used, act only locally and for short periods of time upon the pulmonary surface, but upon the whole body for a considerable time, its influence must *à priori* be regarded as entirely different from what has been previously described.

If we investigate the properties which the air acquires in its condensation by a higher atmosphere pressure, we find in the first place that, by the increased tension resulting from the compression of a larger volume of air to a smaller one, it must also exercise a greater pressure generally upon the bodies placed within it, and secondly, that by the same process its constituent parts have increased in weight, and as they are inspired for a considerable time, two hours long and more, they behave differently towards the animal body than was the case with pressure acting locally. Lastly, as not only the respiratory organs, but the whole body is exposed to the action of compressed air, the change in its density will also be felt by the organs of sense, and in our enquiry into the physiological influence of change of pressure in the pneumatic chamber we shall have to distinguish—

1. The mechanical influence upon the organs and their functions more or less exposed to the increased atmospheric pressure, and in the first place on the organs of sense.

2. The chemical influence on the exchange of gases and the oxidising processes in the animal body by the increased absorption of the constituents of atmospheric air by respiration.

The double physico-mechanical and chemico-physiological influence of compressed air on the organs and tissues exposed to it and its effect upon the physiological functions also forms the

scientific basis for its employment in pathological conditions, and we shall be able to determine later on the indications in each case according to the possibility of the retrogression of these conditions, either by the predominant use of one mode of action of compressed air or by the combination of both.

(A) MECHANICO-PHYSIOLOGICAL ACTION.

1. *Action on the Organs of Sense.*

The increased pressure to which the air is subjected in the pneumatic apparatus affects in the first instance the organs of sense, and first of all it causes a feeling of pressure in the

*Ear,*

which is due to the difference between the density of the external air and that of the air enclosed in the tympanic cavity. Since the outer auditory canal, which conveys the air to the outer surface of the tympanic membrane, is considerably wider than the canal of the Eustachian tube, the increased pressure acting from without will produce a bulging inwards of the tympanic membrane, accompanied with a sensation of obstruction in the ears, earache, singing in the ears. If this difference is equalised after 20 to 30 minutes with the beginning of constant pressure, and generally after repeated cracklings in the ears, the auditory troubles gradually disappear and remain absent as long as the pressure is maintained at the same level. When, however, towards the end of the sitting the pressure diminishes and passes slowly into the normal atmospheric pressure, the difference of pressure on the outer and inner surface of the tympanic membrane again makes itself felt, but in a less degree, because the escape of the denser air from the Eustachian tube occurs more slowly, and gives rise to the sensation of occlusion of the ear and bulging outward of the tympanic membrane. The equalisation here also takes place with repeated cracklings, while the patients distinctly feel the outflow of the air from the pharyngeal orifice of the Eustachian tube in the form of bursting of air bubbles.

The intensity of the sensations in the ear caused by these

differences of pressure will be dependent on the width of the Eustachian tube. In persons in whom it is relatively wide, as is the case with most children, they are not felt at all; on the other hand in catarrhal swellings or other obstructions in the Eustachian tube they may increase unpleasantly even up to actual pain, and necessitate a reduction of the condensation of air or an alternate increase and reduction till equilibrium is completely restored. Repeated efforts at deglutition, swallowing small portions of water, Valsalva's experiment, and lastly catheterisation of the Eustachian tube, will speedily induce an equalisation of the relations of density and disappearance of the troublesome symptoms.

Acuteness of hearing will always be diminished as long as the ear is pressed upon, and it also remains decreased during the constant pressure, as the denser air is less favourable to the conduction of sound, and it is only deaf patients who hear more acutely in condensed air than under the ordinary atmospheric pressure.

Another immediate result of increased density of the air in the chamber is

*Alteration of the Voice.*

which assumes an unnatural metallic sound and gains in height and intensity. The former is no doubt dependent on the shape and the hermetic closure of the apparatus, while the latter phenomenon may possibly be caused by the increased force of the respiratory movements. Thus v. Vivenot detected a rise of half a tone in the voice of a female singer; whereas in normal air she had difficulty in reaching C in alt. with an excess pressure of  $\frac{3}{4}$  atmosphere, she was able with ease to bring out C sharp in alt. On the other hand the production of articulate sounds is impeded, the tongue becomes slower in its movements, whistling is impossible, and even stuttering sometimes occurs. These disturbances are the result of involuntary muscular contraction of the facial, frontal, and cervical muscles even during the transition stage. According to v. Vivenot

*The Senses of Smell, Taste, and Touch*

are also lowered while a high pressure weighs upon the surface of the body. Foley's observations are in accordance with this. Lastly,

*The Sensitiveness of the Nervous System*

generally is diminished, and residence in the apparatus usually exercises a soothing, usually even a soporific influence upon excitable patients. Only in rare cases Junod and Weber observed an increased sensitiveness of the nervous system. Considerable condensation produced a soporific effect on Simonoff, so that in many sittings he was hardly able to read, and had great difficulty in overcoming the drowsiness which threatened to get the better of him.

## 2. Action upon the Respiratory Organs.

### (a) *With Increasing Pressure.*

The pressure exercised upon the whole surface of the body in the pneumatic chamber acts similarly, through respiration, on the surface of the lungs; the various parts of the body will be subjected to it in varying degrees according to their situation.

While the surface of the body and the lungs are influenced immediately by the higher pressure, the blood being more or less displaced from the surface of the body and the lungs expanded, this influence takes place more slowly in the deeper parts and only under steadily increasing compression of the superficially seated organs; meanwhile time enough is allowed for equalisation of the difference of pressure between these. The local influence of the pressure resulting from this will last till the pressure action has been transferred to each cell, to the softer and harder textures of the tissues of the body, and to its fluids, and will therefore necessitate a varying period, which, however, will always be longer than that assigned to the course of treatment in the pneumatic chamber, apart from the transition stage.

Owing to this mechanical relation of the body to the pressure to which it is subjected, it is only slowly that the influence of compressed air in the pneumatic chamber becomes generally felt, and we must accept the explanation given by Knauth as on the whole satisfactory. The intestinal gases, whose tension admits of the greatest change of volume, will be chiefly subjected to the mechanical influence of compressed air, and by compression from the pulmonary surface allow of a depression of the diaphragm and an enlargement of the pulmonary space, even though this suffers a reduction to some degree by the compensating pressure on the external surface of the abdomen.

The following simple experiment, described by Panum, may serve to demonstrate the diminution of the volume of intestinal gases. The bladder *a*, fig. 87, is half-filled with air and hermetically enclosed in the glass vessel *A*, which is filled with water up to the cork. Then another bladder *b* is introduced into the same vessel, so that its stiff neck *c* protrudes through an orifice in the cork *e* which closes the vessel air-tight. An india-rubber plate forms the base *f* of the vessel. As the cork is fitted air-tight into the mouth of the vessel and the neck *c* of the second bladder *b* is also inserted air-tight into its orifice, only the interior of the bladder *b* is in communication with the outer air. The vessel of water *A* represents the thoracic and abdominal cavities; the indiarubber floor answers to the muscular parts of the walls of those cavities; the bladder *a* represents the intestines filled with gas, and the bladder *b* the lungs, which communicate with the external air by means of a stiff tube (the trachea). If this apparatus is now brought into condensed air, the bladder *b* immediately inflates, the indiarubber floor of the vessel is forced in, and the bladder *a*, which represents the intestines filled with gas, diminishes in circumference.

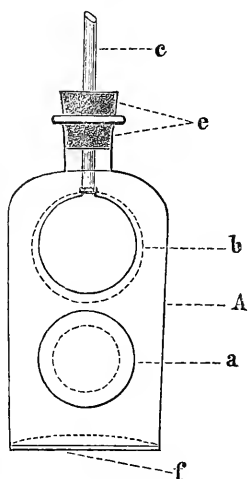

FIG. 87.

The changes of volume resulting from the pressure action of compressed air are delineated in the figure by dotted lines. In

the same way an increase of the tension of the intestinal gases or of the air in the bladder *a* under normal or diminished external atmospheric pressure will induce an elevation of the diaphragm into the thoracic cavity with reduction of the pulmonary space, an outward curvature of the soft abdominal walls; or an increase in volume of the bladder *a*, a diminution of the bladder *b*, and an inflation of the caoutchouc membrane *f* closing the vessel.

Another immediate effect of gradual increase of pressure is the diminution of the obstacles which resist the flow of air into the lungs, by an increase of the difference between the pressure of the external air and that which fills the lungs. If the desired condensation of air amounts to  $1\frac{1}{2}$  atmosphere, or 15 inches beyond the ordinary 30 inches of the mercury column in the barometer, and the period of gradual condensation lasts half an hour, the pressure of the outer air will increase half an inch per minute. Thus with every respiration—a decrease in frequency of 10 respirations being estimated in condensed air—a differential rise of  $\frac{1}{20}$  inch between the pressure of the external air and that contained in the lungs will occur (Simonoff). This difference of pressure will be of therapeutic value, as it allows the air to flow more freely through the bronchi into the pulmonary vesicles, especially in those affections of the respiratory organs in which the obstacles to this influx of air have reached a considerable height.

(b) *With Constant Pressure.*

After prolonged action of increased pressure the pressure will to a certain extent gradually become equalised, the body will accommodate itself to the pressure now acting uniformly upon all its parts, and the mechanical changes will maintain a certain constancy.

This constancy of relations in the first place prevents the dilatation of the lungs in condensed air beyond the normal limits, even when the density of the surrounding air is considerably increased. Only in certain parts of the lungs which lie near the heart, the vessels, the tissues between the ribs and the diaphragm, an expansion of some extent may take place under the influence of condensed air, as the volume of the

former is reduced and the latter is depressed still lower into the abdominal cavity. But in those parts of the lungs which lie close to the heart and the great vessels, and which also are less movable and less full of air, a counter-action is immediately set up by the elasticity of the adjacent organs and tissues. With regard to the dilatation of the parts adjoining the diaphragm, the physical limits of the ordinary fluctuations dependent on greater or less distension of the intestinal canal with gases and food are not exceeded by a condensation of air of  $\frac{2}{5}$  to  $\frac{3}{7}$  atmosphere excess pressure.

If the pressure continues to act steadily after the lungs have reached the limits of their expansion, it will gradually lead to a compression of their tissue proportional to the degree of condensation of the air. Certain parts of the parenchyma of the lungs, according to their compressibility, the cellular tissue, the elastic fibres, the vessels, nerves, and glands, become more or less compressed, and thus the lumen of the several pulmonary vesicles and the lung capacity itself is enlarged.

The pressure exercised upon the vessels of the lung tissue produces also a reduction of their diameter and of their blood contents, whereby also more space is gained, especially in cases in which capillary dilatation and collateral fluxion have been set up. The circulation in these organs will also be facilitated. Lastly, the compression of the glands and the connective tissue causes a migration of the parts set free from them partly into the blood and the lymphatics and partly into the air cells, and thus promotes the absorption and secretion of fluid or dissolved substances in them.

As the pressure of condensed air is not limited to the lungs, but extends to the organs lying between the inner surface of the thoracic wall and the outer surface of the lungs, viz. the heart, the aorta, the pulmonary arteries, both *venæ cavæ*, the thoracic duct, and the lymphatics, and it has therefore to overcome the whole amount of resistance offered by the elastic lung tissue, its effect must necessarily be decreased in a degree proportional to this resistance. The immediate result of pressure action on these organs is also an increase of their consistency, a reduction of their blood contents, a stimulation of absorption and outflow. As all air pressure, however, acts less

on these organs than on the lung tissue, it induces, in ordinary as well as in condensed air, a continuous tendency of the blood and the nutrient fluids to migrate from the vessels and tissues of the lung into them, whereby the circulation of blood in the lungs and the absorption of fluids are very much facilitated. As the difference between the pressure acting upon those organs and that which acts upon the lungs is greater in condensed air than in ordinary air, in consequence of deeper respiration, therefore Simonoff assumes that the effort of the blood and other fluids to escape from the lungs into those organs must be correspondingly greater.

(c) *With Diminishing Pressure.*

If after a certain time pressure is gradually lowered and the air is gradually rarefied, till it reaches the ordinary atmospheric pressure, the same process of gradual equalisation which took place with increasing and with constant pressure will also now occur.

The surface of the body, the skin, and the lungs will be the first affected. The tissues of the skin and of the superficial mucous membranes will again expand, their vessels gradually become richer in blood, the intestinal gases again increase in volume, and the diaphragm be elevated. The air will pass with increasing facility out of the lungs into the bronchi; their parenchyma will expand more and more, and the vessels fill with blood. In this way the lung will gradually contract again and its capacity be diminished. But since the pressure within the lungs, owing to the slow and steady reduction of the external pressure up to complete equalisation, is always greater than the latter, it will impede the contraction of the thorax and lungs in expiration and promote their expansion in inspiration. The afflux of blood into the pulmonary vessels is also retarded, and the danger of their rupture by too sudden a decrease of pressure is also averted. If the transition from a higher pressure of air to a lower one is too sudden, the equalisation of the difference of pressure resulting from local pressure action will occur too rapidly and with violent phenomena, termed perturbatory phenomena, which are to be carefully avoided (v. infra).



### 3. *Action on the Mechanism of Respiration.*

Having described the effects of compressed air on the respiratory organs and the theories deduced therefrom, we now pass on to the consideration of the observations which have been made as to the influence of increased pressure on the *mechanism* of respiration. These observations will refer—

1. To the respiratory movements, the mode of their performance, their number and depth ;
2. To the activity of the parts concerned in this process, in their action on the framework of the chest ;
3. Lastly, to the changes in the pulmonary capacity developed under the influence of increased pressure.

We must not, however, limit ourselves to observing only those changes in the respiratory apparatus which occur while under the influence of compressed air in the pneumatic chamber, but we must also notice how long they persist after returning to the normal atmospheric air, or how far a permanent change has been secured.

Action—

#### (a) *On the Respiratory Movements.*

As we have already shown, the respiratory movements are more easily performed in compressed air, on account of the diminution of the obstacles to respiration, than in ordinary air, and that not only during the period of its immediate influence but even for some time after.

The first and most direct result of residence in compressed air is therefore reduction of the labour involved in the respiratory act. This relief is especially felt by patients whose respiration in ordinary air is laboured. Thus Simonoff reports that in the case of 37 patients who suffered from chronic catarrh of the air passages with dilatation of the lungs the dyspnœa decreased perceptibly after on an average 9 to 10 sittings, and completely disappeared after 34 sittings.

The rhythm of the respiratory movements is also changed in the pneumatic chamber. Inspiration is on the whole facilitated ; expiration becomes more laboured and slower. Where, as under normal air pressure, the period of inspiration as compared with

that of expiration is as 4 : 5, in condensed air their respective ratios are as 4 : 6, 4 : 7, sometimes even as 4 : 8 and 4 : 11.

A retardation of respiratory frequency and a deepening of the respirations are also observable. In 21 observations tabulated by Simonoff the number of respirations decreased on an average by 1.5 respiration in the minute after 20 minutes' residence in compressed air, i.e. at the end of the period of gradual condensation, when a constant excess pressure of  $\frac{3}{7}$  atmosphere was attained. After the expiration of an hour and 20 minutes, at the end of the period of constant pressure, it had decreased by 3 respirations; in the course of the next 40 minutes, during the period of gradual rarefaction of the air to the normal, the respiration became again more frequent, and at the close of the experiment amounted on an average to 0.76 less than before the commencement of the sitting. V. Vivenot's observations, made on himself and on another subject of experiment, may be tabulated with these in the following manner:—

	After 20 min.	After 80 min.	After 120 min.
Average numbers from Simonoff's 21 observations . . . . .	1.5	3	0.76
Average numbers from v. Vivenot's observations on himself . . . . .	3.5	3	2.5
Average numbers from v. Vivenot's observations on N—u . . . . .	2.25	2.8	1.5
Average numbers from all the observations . . . . .	2.42	2.93	1.59

According to these experiments, the numerical results of which must vary according to the varying individuality of the subjects, condensed air has the effect of retarding respiratory movements during the period of highest condensation, a retardation which does not disappear immediately on removal from the condensed air.

Also, according to the observations of Sandahl, G. Lange, Panum, v. Liebig, and others, after the return to normal atmospheric pressure the respirations certainly become more numerous and not so deep, but they do not immediately return to the original condition. After regular daily application of condensed air the respiration generally becomes less frequent, and this diminution of respiratory frequency continues till it has reached a certain limit which it never exceeds. After 77

sittings the number of v. Vivenot's respirations had been reduced from 20·5 in the minute to 4 to 4·5, therefore diminished by 16 respirations in the minute; the subsequent 30 sittings produced no effect on respiratory frequency; it was maintained at 4 to 4·5 respirations in the minute. This great reduction of respirations must, however, be regarded as exceptional, as also the case observed by Tutschek of a tall, muscular, well-nourished man whose respirations fell from 17 to 3.

In order to ascertain the increased depth of the respiration v. Vivenot made comparative measurements of the circumference of the chest at the level of the nipple during the different movements of quiet respiration in ordinary and in condensed air, and he found that after 20 minutes spent in condensed air the periphery of his chest during inspiration had increased by 3·29 millimetres, after an hour and 20 minutes by 4·83 millimetres, and after 2 hours at the close of the sitting by 5·75 millimetres; after 5 sittings the circumference of Vivenot's chest during a quiet inspiration of ordinary air amounted to 6·59 millimetres, after 17 sittings to 9·47 millimetres more than before the beginning of treatment by means of compressed air.

Panum has found by spirometric measurements that the depth of ordinary calm respiration in the course of the first sitting in condensed air increased on an average by 270 cubic centimetres—from 480 cubic centimetres in ordinary to 750 cubic centimetres in condensed air. In the course of the second sitting the depth of quiet respiration increased up to 900 cubic centimetres, i.e. in comparison of its depth previously to the first sitting by 420 cubic centimetres. This increased depth of respiration is no doubt chiefly dependent, as Simonoff insists, on the increased atmospheric pressure in opposition to the amount of oxygen contained in the condensed air, which tends to make the respiration more superficial, as the former expands the lumina, and consequently the capacity of the air passages, and depresses the diaphragm further into the abdominal cavity.

Lastly, according to v. Vivenot's observations, the retardation and the deepening of the respirations, although they are usually found proportional, are not solely and absolutely dependent on

one another, and the retardation of respirations is by no means the only result of increased depth, and conversely.

Cases have been observed in which respiratory frequency was retarded without any increased depth of the respirations.

(b) *On the Mobility of the Thorax.*

It follows directly from v. Vivenot's measurements in reference to the increased depth of respiratory movements that there is an increase of the mobility of the thorax from the action of compressed air. Its expansion increased at the level of the nipples in the course of the first sitting on an average by 5.75 millimetres, and after 17 sittings 9.47 millimetres. In eleven observations which Simonoff made on various persons the difference ascertained by percussion between the deepest inspiration and deepest expiration had increased after 18 sittings by 1.37 rib on an average, or after 10 sittings by 0.65 rib. V. Vivenot in the same way showed in his sittings that the hepatic dulness begins lower down in condensed than in ordinary air, at the time of deepest inspiration as well as that of deepest expiration, in the first case on an average by 1.425 centimetre, in the latter by 1.225 centimetre. Panum has discovered further in his spirometric experiments that in quiet respiration the limit of the average respiratory position in condensed air approaches the limit of the deepest inspiration in ordinary air, on an average about 349 cubic centimetres, and is removed from the limit of deepest expiration about 79 cubic centimetres, so that the mobility of the thorax thus increases considerably with regard to inspiration, but is slightly diminished in expiration. Lastly, J. Lange<sup>1</sup> has proved by means of the pneumatometer what v. Vivenot had already expressed hypothetically, that the negative inspiratory and the positive expiratory pressure is increased with increase of atmospheric pressure.

(c) *On Vital Capacity.*

It can be ascertained by the spirometer that the lung not only undergoes a mechanical expansion but that it also receives a larger quantity of air, so that its vital capacity is increased.

<sup>1</sup> J. Lange, *On Substantive Emphysema and its Treatment with Compressed Air*. Dresden, 1870.

According to v. Vivenot's observations, after 20 minutes' stay in the pneumatic chamber, the excess pressure being  $\frac{3}{4}$  atmosphere, the quantity of air expired after a deepest inspiration rose on an average by 73.40 cubic centimetres and increased after an hour and 20 minutes by 105.57 cubic centimetres, i.e. by  $\frac{1}{30} \frac{1}{23}$  or 3.30 per cent. of the original amount; after two hours, at the close of the sitting, in which the air was again at the normal atmospheric pressure, it amounted to 55 centimetres more than before the commencement of the sitting.

According to eleven observations made by Simonoff on different persons, the following figures represented on an average the increased quantity of air expired into the spirometer during the stay in the pneumatic chamber: after 20 minutes +108 cubic centimetres, after an hour and 20 minutes +94, and at the end of the sitting +24 cubic centimetres.

After daily respiration under increased pressure the amount of a deepest inspiration (or the pulmonary capacity) in Vivenot increased gradually even in ordinary air, at first more rapidly, later on more slowly. At the end of the first month this increase amounted to 400 cubic centimetres, at the end of the second month 200 cubic centimetres more, at the end of the third month only 100 cubic centimetres, in the course of three months therefore altogether the considerable difference of 700 cubic centimetres,  $\frac{1}{5}$  of the natural amount of vital capacity fixed by Hutchinson. In the course of the fourth month of pneumatic treatment Vivenot's vital capacity neither increased nor diminished; it remained stationary at the same height which it had attained at the beginning of the third month. The daily increase of pulmonary capacity, according to Vivenot's collective observations, on an average amounted to 20 to 30 cubic centimetres. If from the above figures we take into account the first month of treatment, i.e. the period of the greatest increase of vital capacity, we have an increase of 13.3 cubic centimetres in 24 hours.

In four observations of v. Vivenot's in other persons the figure did not rise above 7.5 cubic centimetres. This latter figure also approaches the daily increase of vital capacity which Simonoff found in his twelve observations made on different persons, on an average 5.5 cubic centimetres in 24 hours.

This increase of vital capacity can be ascertained by percussion in the region of the diaphragm, as well as over the cardiac area. The diaphragm is depressed  $\frac{1}{2}$  to 2 centimetres under  $\frac{3}{7}$  atmosphere excess pressure; the area of cardiac dulness diminishes, because the anterior margins of the lungs are extended over the heart; the cardiac impulse is therefore less perceptible and the heart-sounds less audible. In the same way after long-continued use of the pneumatic chamber the increase of capacity can be proved to have become habitual by the permanent depression of the diaphragm under normal air pressure. The diaphragm in these cases remains more deeply depressed than is normal during the inspiratory and expiratory position, so that the base of the lung, the vital average position of the lung, approaches that position which the lungs assume in the deepest inspiration.

The greater expansion of the lungs which is maintained up to a certain degree even after exposure to increased pressure admits of the assumption that, in the same way in which the mobility of the thorax is increased, the elasticity of the lung tissue may increase under continued use of compressed air. This increase is to be regarded as a consequence of equalisation of pressure (Knauthe), as the rising pressure remaining constant in the chamber the rest of the time induces a mechanical expansion of the lungs, while the decreasing pressure, like expiration into rarefied air, which it actually represents, induces a mechanical retraction of the lungs.

#### 4. *Action on the Circulatory Organs.*

##### (a) *On the Heart and the Circulation generally.*

The pressure which the air exercises in respiration from the surface of the lungs upon the heart and the great vascular trunks will, as has already been demonstrated, be less in proportion to the amount of resistance offered by the elastic lung tissue, than that which it exerts upon the alveolar walls and upon the surface of the body. In ordinary air this resistance of the tissue is approximately equivalent to the pressure of a column of mercury 8 millimetres high, while in condensed air, where the more strongly filled lungs offer a greater resistance

to the pressure exerted upon them, the resistance of the tissue also increases, and Simonoff places it at about 10 millimetres mercury.

If we add the ordinary atmospheric pressure = 756 millimetres to the excess pressure of  $\frac{3}{7}$  atmosphere = 324 millimetres mercury, we get 1,080 millimetres mercury, and the pressure on the heart and the large vessels of the thoracic cavity will amount in the first case to = 748 millimetres mercury, in the second case = 1,070 millimetres, i.e. 322 millimetres more.

The increase of absolute pressure by 322 millimetres in condensed air must proportionally antagonise the dilatation of the heart and aid its contractions. The immediate result of this is to diminish its distension with blood, to lessen the extent of its contractions, and to reduce the blood pressure, while the increase of the difference of pressure raises up to at least 10 millimetres mercury the suction action which the thoracic cavity exercises upon the blood of those parts which are exposed to the full pressure. Even under normal conditions the resistance which the vascular walls offer to the blood current moving in them and to their distension varies, and a constant and important condition of its amount is given in the inequality of the air pressure to which the various parts of the body are subjected. This condition will remain the same in condensed air also; only the amount of resistance will increase proportionally to the heightening of the atmosphere pressure, and thus induce a diminution of the quantity of blood in the different organs corresponding to the diminution in the blood current. The vessels of the lungs and air passages, those of the external surface, those of the oral and other mucous membranes which are directly exposed to the air, are most susceptible to this pressure and are least distended by the blood current as it forces its way on; whereas the vessels of those organs and tissues which lie in cavities with rigid firm walls—e.g. in the cranial cavity, in the vertebral canal, and partly in the abdominal cavity, or, in the bones, in the cartilaginous tissue, in the muscles and glands, of more resistant structure, which are but little if at all compressible by air pressure—their vessels become most full of blood, which gradually accumu-

lates within them and distends them, and its fluid and constituent elements, if long detained there, transude in large quantity and give occasion to nutritive and functional changes.

(b) *On the Peripheral Vascular System.*

So soon as the air, as its condensation increases, begins to exercise more and more pressure upon the surface of the body, the more compressible soft parts immediately succumb to this influence, in the first place the capillaries, then the lesser venous trunks and arteries, and lastly even the largest peripheral vessels become more and more compressed and the mass of blood moving within them displaced.

The phenomena of peripheral displacement of blood had been already observed by Junod, Ch. Pravaz, Petrequin, Sandahl, and others. Thus, according to v. Vivenot's experiments, the bloodvessels in the external ear of the rabbit become thinner and paler in condensed air, and sometimes even disappear altogether to the eye. The conjunctiva and retina also become paler, as well as the red iris and pupil in these animals, and v. Vivenot is inclined to think that these changes in the amount of blood contained in the eye with synchronous diminution of the intra-ocular pressure are not without influence on the movements of the iris, and that the contraction of the pupil under strong air pressure observed by him and others is to be referred to these influences. Even pathologically distended vessels will undergo the same change of dimension as the normal; the morbid sense of pulsation of the ear and jaw in toothache disappears (Panum); the red injection of the inflamed tympanic membrane (Freud, v. Vivenot, and others), the sensation of pain and heat in the region affected by erysipelas (v. Vivenot), the hyperæmia and swelling of the inflamed mucous membranes in acute nasal and pharyngeal catarrh rapidly diminish, and Suchorsky and Kondratjew have observed with the aid of the laryngoscope a decrease of engorgement in the vessels of the catarrhally affected laryngeal mucous membrane in condensed air. The diminution of hyperæmia of the skin and mucous membranes only becomes very considerable under high degrees of condensation of the air, and Foley speaks of a 'remarkable' bleaching of the skin of workmen during



their stay in a chamber the air of which was condensed to  $3\frac{1}{2}$  atmospheres, and this had occurred notwithstanding a very high temperature in the chamber.

(c) *On the Pulse.*

The action of pressure has the same influence on the pulse. In condensed air it becomes smaller (*parvus*), slower, both with regard to the number of its beats in the minute (*rarus*) and also the duration of the distension of the arterial tube during the formation of a pulse-beat (*lentus*). Under very high pressure of 2 to 3 atmospheres it becomes smaller and smaller, weaker, and at last thread-like (*filiformis*, Foley) and scarcely perceptible.

The pulse frequency sinks gradually from the beginning of the sojourn in condensed air to the end of the period of constant pressure, rises again slightly in the period of gradual rarefaction, but without reaching its former height at the end of the sitting, when the density of the air has again become normal. From 51 observations Simonoff made the following deduction: After a sitting of twenty minutes the pulse frequency was diminished by four beats, after one hour and twenty minutes by eight beats, and after two hours, or at the end of the sitting, by five beats below the rate under normal air pressure. The average estimate which v. Vivenot gives was taken from observations made on himself. According to these observations the number of pulse-beats during the whole course of the sitting decreased steadily, and this decrease, which reached its height at the end of the sitting, amounted after twenty minutes to 3.45 beats, after one hour and twenty minutes to 6.33, and at the end of the sitting to 7.33 beats. Sandahl's observations made on 75 different persons are entirely in accordance with those of Simonoff.

The retardation of the pulse, like that of the respiration, is all the greater the quicker it was before the application of increased atmosphere pressure, so that in the case of persons with average or subnormal pulse frequency of 68 to 64 beats in the minute the decrease is slighter, in that of patients with abnormally hurried pulse far greater than the figures given. Thus Simonoff obtained as maximum 20 beats, v. Vivenot 31, Bertin 30 to 36, and Sandahl 26 beats to the minute.

The retardation of the pulse obtained during the respiration is not maintained in the same proportion after the return to normal pressure, but, according to V. Vivenot, again returns to its original frequency in half an hour to an hour and a half, and seldom lasts many hours. As an exception Bertin observed a retardation of the pulse which did not occur during the sitting, but some hours after it and on the following day. A permanent lowering of pulse frequency can only be obtained indirectly by means of compressed air. If the quickening of the pulse was originally caused by respiratory obstruction, after removal of the latter we may expect a secondary decrease of pulse frequency from the action of compressed air.

To explain the retardation of the pulse, asserted by all observers, from Tabarié down to the present time, various contradictory theories have been advanced—that of V. Vivenot, quite recently that of Simonoff, and a third, Liebig's, entirely denying it, while Poiseuille, Junod, and François have erroneously attempted to show that it behaves indifferently or that there is even an acceleration of the pulse wave.

According to v. Vivenot the lowering of the pulse frequency occurs in the first instance in a purely mechanical manner. By the increased pressure on the surface of the body the resistance which the blood wave forced out in systole finds in the artery subjected to the same pressure is increased; thereby the cardiac action itself must be impeded, and the frequency of cardiac pulsation thereby retarded, as, according to Marey, the heart beats the more frequently the more easily it can empty itself.

In traces of the pulse wave in the radial artery taken by means of Marey's sphygmograph V. Vivenot obtained curves which show a change in the form of the pulse waves. The height of the curves was on the whole depressed; the line of ascent and the primary elevation became less erect and weaker, and the apex rounded; the decrease of the altitude caused the line of descent to fall less suddenly, and to be thus transformed from a wavy curved line into a straight line more or less convex in the upper part; the re-contraction of the artery did not therefore occur rhythmically with the formation of a dicrotic wave, but quite uniformly with absence of dicrotism. As the pressure gradually ceased the pulse wave also altered and

returned to its former condition. At the same time v. Vivenot observed an elevation movement of the writing lever on the sphygmograph during the stage of increasing pressure, although the instrument had not in the least undergone a change of position, so that he thought this phenomenon was to be referred to an increase of blood pressure in the radial artery. Parallel experiments performed by Vivenot with the aid of an artificial indiarubber construction gave the same changes of the curves as the natural ones, traced under increased pressure, and showed also that the polycrotism observable in the line of descent is to be regarded as the expression of the successive blood waves generated by interference and of the wave movements communicated to the elastic wall of the vessel.

From these tracings, which all bear the mark of increased arterial tension, v. Vivenot concluded that the lumen of the vessel examined was reduced under increased atmospheric pressure, whereby on the one hand the resistance offered to cardiac systole was increased, on the other hand the relative amount of blood in the vessel itself was increased and the outflow into the capillaries was obstructed.

In opposition to these deductions Simonoff asserted that in Vivenot's tracings the most considerable flattening of the pulse waves generally coincided with the end of the period of constant pressure, sometimes even with the end of the sitting, or that it might even occur, after the lapse of some time, under ordinary air pressure. He also calls attention to the fact that not only does a prolongation of the line of ascent of the pulse wave take place, which led Vivenot to conclude that the artery opposes an absolutely greater resistance to its distension by the blood sent to it from the heart, but also the same prolongation is seen in the descending line of the pulse wave, which points to a quite opposite condition of the arterial walls, and this change was maintained even after the sitting, therefore at a time when no increased pressure was present; consequently there was no further occasion for an increased resistance on the part of the arterial wall. Simonoff therefore sees in these changes of the pulse waves not a stimulation but a depression of the force of the heart's action and of blood pressure; even in ordinary air when there is diminished frequency of cardiac contractions

there must occur a flattening of the pulse waves and a prolongation of their line of ascent, as a result of the lowering of the force dilating the vascular walls and of the consequent relative, not absolute, increase of resistance. If the contractions are at the same time retarded, as is actually the case in condensed air, the flattening and lengthening of the ascending wave line of the pulse would necessarily appear even more considerable, and be attended with a lengthening of the line of descent also. Then the rise of blood pressure might be solely dependent on an increase of the whole mass of blood or on a diminution of the blood channel or of the capacity of the vascular system, the mass of blood remaining unchanged, and lastly in proportion to the increase of the frequency and the extent of the cardiac contraction; opposite conditions will lead to a decrease of blood pressure. But supposing the mass of blood to remain unchanged only at the first commencement of the sitting and then a rapid fluid excretion to come on, this will have the effect of producing a rapidly progressive diminution of it; so also will it induce a lessening of the frequency and extent of the cardiac contractions, as can be proved by direct observations, and only the narrowing of the blood channel resulting from the diminution of the calibre of the vessels in those parts of the body which are exposed to the direct influence of increased air pressure will eventually remain for Vivenot's assumed increase of blood pressure. Vivenot, in his theoretical deductions concerning the increase of blood pressure in condensed air, has taken only this factor into account, leaving the others unnoticed; a narrowing of the blood channel or of the capacity of the vessels would only be capable of raising the blood pressure if a diminution of the mass of blood did not occur at the same time; but this actually takes place under the influence of condensed air and in a rapid manner (v. *infra*). Simonoff therefore concludes that all the sphygmographic changes of the pulse wave which Vivenot described and regarded as signs of increased force of cardiac action are really due to a decrease of the force of the heart's action.

Direct measurements of the pulse made by Waldenburg in the pneumatic chamber of the Berlin Jewish Hospital, under Dr. Lazarus, show the following changes in the radial artery:—

In accordance with the previous observations on superficial vessels, the fulness of the artery diminished with the increased pressure, its diameter being narrowed proportionally to the increase in the pressure of the external air; at 760 millimetres Hg it amounted to 6.55 millimetres; at 820 millimetres Hg it was reduced to 6.37, and at 1,150 millimetres Hg to 5.83 millimetres. So also the *size* of the pulse decreased with increased pressure, sinking from 0.10 to 0.06; in the transition to normal pressure it rose again to 0.08 millimetres, but failed to reach the initial height. With the size of the pulse the *strength* of the pulse also decreased; with an excess pressure of 8.80 gr. millimetres it sank to 5.58, and when the pressure diminished it remained under the original height. The two last changes in the size as well as the strength of the pulse are to be regarded as secondary effects of sojourn in compressed air.

It was further ascertained by experiments with the angiometer (*Pulsuhr*) that the circulation was retarded under increased pressure and, what had not hitherto been proved, quite independently of the pulse frequency. Whereas the quotient of circulation in the initial pressure of 820 millimetres Hg amounted to 31.8, i.e. corresponded to the average measure of a healthy person, it rose with increased pressure to 48 and sank again with decrease of the pressure to 41; or whereas in the initial pressure the 31st part of the total mass of blood was arterialised by each systole, here only the 48th part reached the pulmonary artery. The accompanying retardation of the pulse from 76 to 60 beats in the minute produced a still further retardation, which showed itself in the coefficient of the blood changes. While under initial pressure the circulation was completed in 25 seconds, with increased pressure it became retarded to 48.6 seconds. It was also shown here as well as in Vivenot's observations that as a secondary influence in the return to normal pressure the circulation was indeed accelerated, but did not return to its former rapidity.

As regards absolute blood pressure, it was found to be slightly increased under the influence of compressed air; on the other hand relative blood pressure, i.e. blood pressure in relation to the surrounding air, was considerably reduced.

With an air pressure of 820 millimetres Hg the absolute blood pressure amounted to 268 millimetres Hg, and with an air pressure of 1,150 millimetres Hg only rose to 273 millimetres Hg. Yet if we compare the figures of blood pressure obtained with the pressure of the surrounding air, according to Waldenburg we obtain another more correct type, which expresses itself most precisely in the equivalents of weight representing blood-pressure tension. With a pressure of 820 millimetres Hg the blood pressure is = 135 grammes, with an air pressure of 1,150 millimetres Hg only 98 grammes, so that the blood pressure has fallen in the ratio of 135 : 98 under compressed air. If we reckon these weights at the normal pressure of 760 millimetres Hg we have a fall of blood pressure from 248 millimetres Hg to 180 millimetres Hg.

Here also, in consequence of the secondary influence of air pressure, a lowering of the blood pressure (285 millimetres Hg) remains on descending to the normal.

Lastly, the reduction in volume of the soft parts as experimentally ascertained by the compressing, i.e. fluid-displacing, effect of condensed air is of special interest here. When in Waldenburg's experiments the compression of air had reached a height of 1,150 millimetres Hg no trace of a pulse was any longer perceptible, and the pelotte had to be screwed down 1.36 millimetre before the pulsation returned.

(d) *On the Blood Pressure in the Vessels.*

Three experiments which v. Vivenot performed on dogs by means of the hæmatodynamometer and the kymographion yielded no decisive result, as two completely failed and in the third so low a degree of blood pressure, = the pressure of a column of mercury of 86 millimetres, was found in the carotid artery as he had never previously observed. The slight rise of blood pressure from 86 millimetres in normal air to 92 millimetres under the influence of  $1\frac{1}{2}$  atmosphere, i.e. = 6 millimetres mercury, is too trifling to lead to any safe conclusion, and we are, on the contrary, justified in assuming that the animal was in an abnormal condition before and during Vivenot's experiment.

On the other hand two of Panum's experiments on dogs

were more successful, and show indubitably a lowering of blood pressure in the arteries under the influence of increased air pressure.

In Panum's first experiment the blood pressure in the dog's carotid artery, which in normal air amounted to 150 millimetres mercury, when the air was condensed to  $1\frac{1}{3}$  atmosphere, answering to a rise of barometric pressure of 140 to 150 millimetres, sank to 138 millimetres. In the second animal experimented on it fell from 154 to 138 millimetres in air condensed by  $1\frac{1}{4}$  atmosphere = a rise of barometric pressure of 200 millimetres. After the close of the sitting the blood pressure rose again, in the first experiment to 165, in the second to 162 millimetres.

J. Lange, one of whose experiments is published, gives no figures, but only mentions that this experiment convinced him of the lowering of blood pressure under the influence of condensed air.

Quite recently P. Bert, in his work 'La Pression Barométrique,' has established the thesis, in accordance with v. Vivonot and in opposition to Panum and Lange, that the arterial tension of the blood is considerably increased in compressed air by the mechanical influence of the pressure. Bert founds this conclusion on two kymographic experiments on narcotised dogs, in which the excess pressure in the pneumatic bell amounted to 530 millimetres Hg. The first experiments gave a rise of the average blood pressure in the femoral artery from 122 to 138, the second in the carotid artery from 58 to 104 millimetres Hg, thus a rise equal to  $\frac{3}{5}$  of the original height.

Jakobson and Lazarus have also put this question to experimental proof and were able to confirm P. Bert's results.

In the chamber of the pneumatic apparatus at Berlin the air pressure was regulated in the same way as during the sittings of the patients, i.e. in the first twenty minutes raised to 420 millimetres Hg in maximo, then maintained constant for an hour, and finally in forty minutes brought back to the normal. As only relative values were sought, Setschenow's method was quite sufficient for the measurement of the average aortic pressure, which was measured at the origin of the carotid artery. Lazarus applied the same to seven dogs narcotised by morphine and four sheep without narcosis, and traced the fluctuations of

blood pressure, as also of pulse and respiratory frequency, during two hours.

In the majority of the observations an increase of aortic pressure continuing beyond the phase of constant, sometimes even that of decreasing, condensation of air, was unmistakable. Together with tables which show the pressure unchanged, or only increased by one to two millimetres Hg, a larger series of other tables are to be found in the protocols, in which an evident increase appears of about  $\frac{1}{1\frac{1}{2}}$ , only once  $\frac{1}{3}$  of the original estimate. So considerable a rise of blood pressure as Bert found in his second experiment was never encountered in these observations. According to Jakobson and Lazarus, judging by the experiences which we possess of the influence of a pressure of two to three atmospheres in the building of bridges, as also on the therapeutic influence of condensed air, the fluctuation caused by an accidental disturbance of the circulation may perhaps be regarded as a symptom of perturbation consequent on the abrupt change of air pressure in the chamber.

Whereas Ch. Pravaz, Panum, v. Vivenot, Freud, Simonoff, and others assume a peripheral displacement of blood resulting from the excess of atmospheric pressure acting on the lungs and surface of the body, v. Liebig does not admit such a displacement as a direct action of pressure, and endeavours to explain it indirectly by the changes observed in the peripheral blood-vessels, as he feels bound to believe in a widening of the blood channel in the lungs, on the ground of the researches of Quincke and Pfeiffer. As Quincke and Pfeiffer have proved, and as has already been mentioned in other places, all the vessels of the lungs are distended and filled more abundantly with blood during inspiration, with increase of negative pressure, whereas in expiration emptying of the vessels is promoted by the elastic action of the lungs now coming into play. As in calm breathing in condensed air the limit of the average respiratory position of the lungs approaches that of the deepest respiration, Liebig finds himself driven to the conclusion that the flow of blood towards the lungs must also undergo an increase, whereby the peripheral vessels would be more emptied.

But all these phenomena in the vascular apparatus are still only to be regarded as simple mechanical processes, evoked by



the higher atmosphere pressure on the surface of the body and the lungs, which can only come into play as centripetal pressure, acting at first more upon the peripheral than the central parts, and must necessarily have for its result a displacement of the blood from without inwards (cf. supra, Waldenburg).

(e) *On the Central Vessels.*

As the blood is displaced from the external parts of the body, whose vessels are especially exposed to the first influence of compressed air, there will immediately be an increased flow of blood towards those cavities in which the vessels are not subjected to the same pressure, but are capable of distension and of receiving the blood which flows towards them in increased quantity.

The abdominal cavity, separated from the thoracic cavity by the diaphragm, and the pelvis are still in a considerable degree accessible to external atmospheric pressure through the latter and the abdominal integuments, and undergo a considerable reduction of their superior and anterior capacity by the depression of the diaphragm and forcing inwards of the abdominal surface. The greater part of the abdominal cavity is meanwhile taken up by the intestines, which are filled with readily compressible gases and whose solid and fluid contents are inconsiderable in comparison with these. As, however, the compressed coefficient of the gases is considerably higher, these become first subjected to the pressure and undergo a reduction of their volume in favour of the less readily compressible parts in the abdominal cavity. In proportion to the amount of gases in the intestines the pressure acting on the diaphragm and the abdominal integuments either exercises no pressure on the vessels, or else the pressure will be considerably less than in those parts of the body which stand under the immediate influence of the air pressure.

Under these conditions the vascular fulness of the organs and tissues contained in the abdominal cavity must increase in condensed air.

We must regard the increase of renal and alvine excretion under the influence of condensed air, already previously mentioned, from the practical point of view as a direct consequence

of this increased afflux of blood to the abdominal viscera, from the greater fulness of the renal artery on the one hand and of the mesenteric arteries on the other and the increased transudation of aqueous fluids from them. In the same manner the menstrual discharge of women is promoted by it, and it may be brought on by pneumatic treatment in those previously suffering from amenorrhœa. The increase of hemorrhoidal flux will also be due to these influences.

On the other hand it is said that in other glandular organs, as the liver and spleen, no tumefactive hyperæmia has hitherto been observed, and that repeated percussion has failed to show any enlargement of these organs (v. Vivenot, Bertin, Sandahl, Pol, François, Foley, and others). Simonoff has even repeatedly observed a diminution in size of these organs in patients who had previously suffered from congestion of them. The explanation of this phenomenon is sought in the fact that the amount of blood in the liver and the spleen is chiefly dependent on the circulatory conditions in the heart, in the lungs, and the thoracic cavity generally, and by the increased suction power of the heart under the influence of condensed air the circulation in them is promoted; in the same way the adjacent integuments and the diaphragm might exercise a higher pressure on them, and lastly the increased alvine evacuations and the improvement in nutrition eventually induce a reduction in volume of the morbidly enlarged liver and spleen.

The vessels most withdrawn from the influence of increased air pressure are those in the cranial cavity and its prolongation, the vertebral canal.

It was natural to suppose from the outset that the cranial cavity, bounded on all sides by bony walls, would shut off the organs enclosed within it from the influences of condensed air, and promote an increased afflux of blood and consequent hyperæmia of the brain and the meninges. V. Vivenot and other physicians therefore consider congestions of the brain to be a direct result of the influence of condensed air, and regard such conditions as counter-indicating pneumatic treatment, although practical experience has long contradicted this hypothesis, as giddiness, heaviness in the head, headaches, and such troubles have been regularly relieved by the influence of con-

densed air; Pol, François, and Foley have never observed any tendency to congestion of the brain even under a condensation of 3 and  $4\frac{1}{2}$  atmospheres, although here the transition from ordinary air to those degrees of condensation took place almost instantaneously. The diminution of the amount of blood in the retinal vessels already observed by v. Vivenot admits no certain conclusion as to the circulatory conditions in the brain, since the (optic) bulb lying outside the cranial cavity is exposed to full atmospheric pressure, and the incompressible intraocular fluids can hardly weaken it very much in its transference to the retinal vessels.

Simonoff tries to prove that the afflux of blood to the brain cannot be abnormally increased, but must be diminished, from the circumstance that the blood is conveyed to the brain only through the carotids and the vertebral arteries, and principally through the former, which are somewhat superficially placed in the neck, and under the compressing influence of condensed air become reduced in calibre and convey less blood to the brain and the meninges. The veins are certainly also compressed by condensed air, but they have a considerably greater capacity and are comparatively imperfectly filled; consequently the blood pressure in them is less (Jakobson found it even negative in the jugular vein); and lastly they anastomose freely. Simonoff also dwells upon the increased suction action of respiratory movement and the diminished extent and frequency of cardiac contractions, as also the lowering of blood pressure from the consecutive diminution of the mass of blood, conditions under which a reduction rather than an increase in the quantity of blood in the brain and the cranial cavity would be likely to occur.

As regards the vertebral canal, we are as yet in possession of no practical observations which would justify us in concluding that there is an increase or decrease of the amount of blood contained in it, otherwise than the anatomical construction and the topographical circumstances admit. There is therefore no doubt that under all circumstances, during a certain period of residence in condensed air, a comparatively stronger afflux of blood towards the vertebral canal would take place than is the case under ordinary atmospheric pressure.

(f) *On the Veins, Capillaries, and Lymphatics.*

As the veins and capillaries are subjected to the same influence of condensed air as the arteries, and the circulation of blood within them is dependent on that of the corresponding arterial vessels, similar changes of blood pressure and blood fulness must occur in them.

Panum instituted direct experiments on this subject by introducing a manometer into the jugular vein of a dog, and found that the venous blood pressure suffered a decrease under the influence of heightened atmospheric pressure. At the very beginning of condensation a diminution of it occurred in the veins and capillaries of the parts of the body in which the full atmospheric pressure rested, while a rise of blood pressure gradually developed in those veins and capillaries which were withdrawn from the direct influence of atmospheric pressure. A diminution of blood pressure in all the veins and capillaries ought, according to Simonoff, to set in from the moment that the quantity of blood is reduced in a measure corresponding to the pressure.

We are in possession of no direct investigations as to the influence of condensed air in the lymphatics. According to the physiological conditions of lymph, its formation and propulsion in the lacunar spaces of the tissues and lymph channels, the hypothesis is probable that—

1. In such parts of the body as are exposed to the direct influence of the increased pressure of condensed air, the passage of the lymph from the tissue spaces into the vessels, as also its further propulsion in the direction of the heart, is accelerated; so also the negative pressure exercised on the heart and the large vessels by the enlarged lungs, and the increased thoracic aspiration thereby induced, also promote the lymph circulation. Lastly, the formation of the lymph itself, so far as it takes place by the passage of blood serum out of the vessels into the tissues, will be retarded, not only by the simple mechanical pressure but also by the decrease of blood pressure through the diminished afflux and increased efflux of blood.

2. The exudation of lymph from the bloodvessels into the

tissues of those parts of the body which are withdrawn from the direct influence of increased air pressure will necessarily be augmented. But as with this augmentation the pressure under which the lymph stands is at the same time raised, its efflux out of the tissue lacunæ and lymph spaces into the lymphatic vessels, as well as its further propulsion, is accelerated even in those parts on which the influence of air pressure is not directly exercised.

The passage of the chyme in the intestine into the villi, as also the propulsion of chyle in the mesenteric lymphatics, is not directly dependent on the degree of density of the air. However, it is possible that by continued excretions from the blood, and the consequent decrease of its quantity, the absorption of chyle may take place more rapidly, and thus the flow of lymph be here also accelerated.

(g) *On Secretion and Absorption.*

Practitioners consider themselves justified in assuming, from such pathological records as exist, that increased air pressure causes a diminution of secretory activity in those organs which are directly exposed to it, and promotes the absorption of morbid products effused into the cavities and tissues less exposed to it.

Thus it was observed that cases of morbid increase of secretion of the nasal, oral, pharyngeal, laryngeal, bronchial, and vaginal mucous membranes, as well as cases in which the perspiration was morbidly increased, were rapidly relieved under treatment in the pneumatic chamber, while, as already mentioned, in the organs withdrawn from the direct influence of the pressure, the intestine and kidneys, an increased secretion of urine and fæcal evacuation was observed.

In cases of exudation and infiltration into the pleural cavity, in the lung tissue, in the abdominal cavity, as also in the subcutaneous and submucous tissues, the physicians observed a greater rapidity of absorption of these products when the patients were subjected to increased air pressure than is usually found to be the case under any other mode of treatment. Theoretically this effect of increased air pressure, as set forth in medical records, is accounted for in the first place by its influence on

those parts of the body which are directly subjected to it; secondly, by the change in those organs which are withdrawn from its immediate influence; and thirdly, by the equalisation resulting from these changes after the removal of the pressure and return to normal conditions.

Where increased air pressure can act directly the blood pressure in the vessels is lowered, the outflow of blood from them into the tissues diminished; on the other hand the afflux of tissue fluid from the lacunæ of the tissues into the lymphatics is promoted, and the passage of the lymph out of the lymphatic vessels into the bloodvessels accelerated under the influence of increased suction action of the heart. Thus absorption of accumulated or effused fluids is increased, and exudation and secretion diminished in the lungs and the rest of the respiratory tract, in the pleura, in the skin, in the subcutaneous cellular tissue, and the mucous membranes accessible to atmospheric air and their submucous tissues, and the female genitals.

In those organs and tissues which are not accessible to the direct influence of condensed air, as in those of the abdominal cavity, the cerebro-spinal canal, in the bones, cartilages, muscles, and partly in the glands, excretion will predominate over absorption, and this will continue till the previous equilibrium is restored in the distribution and the pressure of the blood.

In connection with this, after the return to normal pressure, in consequence of the diminution in the amount of lymph which has occurred and of the relatively greater density of the blood, the absorptive activity will again obtain the preponderance throughout the body over exudation and excretion, and continue active till the quantity of blood has again been renewed by increased absorption of fluid, or a new condition of equilibrium has been set up.

#### (B) CHEMICO-PHYSIOLOGICAL ACTION.

A series of chemical processes are connected with the mechanical changes which air compressed above one atmosphere exercises upon the animal organism during its temporary action, and it is all the more necessary to take these into account in estimating the total effect of the physical treatment, since they,

in their turn, produce alterations of the physical processes in the bodies of animals.

By an excess pressure of  $1\frac{3}{4}$  atmosphere, first the air itself is changed, its density being proportional to the pressure, then the respiratory surface of the lungs is increased in volume; the circulation of the blood, the absorbent and secretory processes undergo changes, according as the organs have been subjected directly or indirectly to the mechanical influence of compressed air. Accordingly the exchange of gases in the lungs, oxidation and generation of heat, tissue metamorphosis and nutrition generally undergo changes which, in proportion to their extent, will act more or less definitely on the state of the whole organism.

(a) *On the Exchange of Gases.*

In the comprehensive researches which have already been made by v. Vivenot, Sandahl, Panum, and G. Lange on the excretion of carbonic acid during respiration of compressed air it has been ascertained that it undergoes a considerable increase with increased pressure.

No direct experiments were made by these observers on the absorption of oxygen, but their views on this question were advanced on theoretical or indirect grounds. Supposing the absorption of oxygen to be increased, they assume that the excess of oxygen was absorbed not only through the lungs, but also mechanically through the skin. In proof of this v. Vivenot brings forward a case observed by Pol in which general cutaneous emphysema, terminating fatally, was set up in a working man under a pressure of 3 to 4 atmospheres; further, that the troublesome irritation of the skin and muscular pains similar to rheumatism which occur during a prolonged sojourn in highly compressed air are connected with the absorption of oxygen by the skin and its liberation again after the return to normal air pressure. Lastly, the brighter red colouring of venous blood, the astonishingly rapid relief of emphysematous dyspnoea, and the disappearance of cyanosis in the face of many emphysematous subjects, as well as the fresher, more blooming appearance of chlorotic and anæmic patients after pneumatic treatment, they consider as supporting their hypothesis.

In opposition to these views G. v. Liebig, supported by a series of analyses of air, has endeavoured to prove—

1. That the excretion of carbonic acid is less under increased than under normal pressure; the deficiency, however, under raised pressure is only 0·3 gramme; it must, however, be observed that this amount, apparently trifling in itself, although found in almost equal volumes, yet refers to air of different densities. Besides, according to his observations, the more copious excretion of carbonic acid is less dependent on the depth than on the number of the respirations, so that the more frequent the respirations in a given time the more carbonic acid is given off than in slower expiration. The results of chemical investigations are here in a certain agreement with the mechanical influence of raised pressure, under which, as has been demonstrated, the breathing is slower, but the respirations become deeper and the expiration protracted. V. Liebig was disposed, however, to refer this change in the excretion of carbonic acid not to an actual diminution of it, but to increased absorption of oxygen. P. Bert asserts that the excretion of carbonic acid suffers no change under increased pressure.

2. V. Liebig also investigated directly the absorption of oxygen under the influence of compressed air, and found it increased. Whereas in the exhalation of carbonic acid the amount was chiefly determined by the number of respirations, the absorption of oxygen, on the contrary, was dependent on their depth. So that the increased absorption of oxygen would coincide with the mode of action of compressed air, in which respiration and inspiration are facilitated. According to v. Liebig's investigations the increase of the absorption of oxygen amounted in equal volumes of inspired air to 11 per cent., but rose when the subject of the experiment was hard at work, and while at the same time the respiratory frequency in the chamber did not differ from that in ordinary air, to a relative amount of 18 per cent. and an absolute of 22 per cent. P. Bert found the absorption of oxygen into the blood only slightly increased under increased pressure. If the normal proportion in the blood is = 20 volumes per cent. of oxygen under normal atmospheric pressure, it rises, according to his experiments, under a pressure of two atmospheres only by 0·9, under one of three atmospheres



only by 1.6 volume per cent. He found the number of the respirations without influence on the amount of the absorption of oxygen. As P. Bert's experiments were carried out in a perfectly exact manner, we may, in deciding the question, regard the amounts fixed by him as reliable (v. also Part I., Oxygen).

*(b) On Oxidation and Generation of Heat.*

One of the most interesting points in these investigations was the behaviour of the temperature of the body during residence in condensed air.

In twenty-six observations which v. Vivenot made on himself and on five other persons the body temperature at the commencement of the period of constant pressure rose on an average about  $0.503^{\circ}$  C., at the end of that period about  $0.344^{\circ}$  C., and at the close of the sitting  $0.212^{\circ}$  C. higher than before it began. In six of v. Vivenot's observations on different persons the temperature (also measured in the axilla) about the middle of the period of constant pressure had risen  $0.8^{\circ}$  C., at the close of the sitting it had fallen again, but still remained  $0.5^{\circ}$  C. higher than at the beginning. V. Vivenot attributed this increased amount of heat only partially to accelerated oxidation during the sojourn in condensed air, as oxidation under these circumstances had risen by 14 per cent., while the heat generated by this combustion could only have warmed v. Vivenot's body, which weighed sixty-four kilogrammes, by  $0.39^{\circ}$  C. instead of  $0.50^{\circ}$  C., if we assume the capacity of heat of the human body, which contains about 75 per cent. water, to be the same as that of water, and the excess of carbonic acid also to have arisen from direct combustion of pure carbon, which is not really the case. V. Vivenot therefore considers that the excess of heat unaccounted for ought to be ascribed to diminished loss of heat in condensed air, as the vessels of the skin and lungs are constricted by the increased atmospheric pressure and receive less blood, which naturally causes a diminution of the radiation of heat and of the evaporation of water through skin and lungs.

The investigations of Stembo, made in the pneumatic chamber of the Jewish Hospital at Berlin, are opposed to the observations of v. Vivenot.

In order to be able to watch thoroughly the influence of

raised air pressure on the generation of heat in the body, Stembo measured the peripheral and central heat of the body by taking the temperature between the fingers, in the axilla, and in the rectum. The air pressure in the chamber amounted at the time to  $1\frac{3}{7}$  atmosphere. As the pressure was rising, as well as at its acme and when it was diminishing, the peripheral temperature, taken between the fingers, sank several degrees, that in the axilla measured some tenths of a degree below the normal; and a persistent lowering of the temperature even some time after the sitting could still be observed as secondary effect. The central heat seemed also to undergo a constant decrease (by 0.9, 0.7, 1.2, 0.5 per cent. C.) after a few but by no means sufficiently numerous observations of the temperature in the rectum. In this case losses of heat through lowering of the temperature in the chamber, as well as by possibly increased evaporation, were completely excluded, as on the one hand measurements of the temperature in the chamber showed a slight elevation during the sittings; on the other hand, by means of the regulatory arrangements, the amount of moisture in the air of the bell could be kept very nearly the same as that of the outer air. Stembo therefore feels bound to refer the constant depression of peripheral and central body temperature to an abnormally diminished generation of heat in the body by increased air pressure. He attributes the divergent results which v. Vivenot obtained to the short time the thermometer was retained in the axilla, for the average temperatures he thus obtained, which almost always fluctuate between  $35.5^{\circ}$  and  $36.5^{\circ}$  C., must be regarded as subnormal. Thus the rise of the temperature which v. Vivenot observed at the commencement of the sitting, and erroneously supposed to be the result of increasing pressure, would be accounted for. Stembo has also made similar observations in cases in which he could not, as is usual, retain the thermometer for a long time, viz. twenty to thirty minutes before the sitting, as is shown by observation 7.

Some of the results of Stembo's temperature observations were very startling. According to v. Liebig's and especially P. Bert's investigations the absorption of oxygen is increased, though the latter says only slightly, under increased pressure; numerous other observations also lead to the conclusion that

there is a stimulation of oxidation in the body, so that we ought to have obtained by careful thermometric observations an evidence of increased generation of heat in compressed air. As this, however, is not the case and v. Vivenot's investigations, as well as the various reports of other observers, have not been confirmed, we must trust to future researches, testing more accurately the group of factors to be here taken into consideration for a solution of this interesting question. (Cf. also Schyrmunski's measurements of temperature under rarefied air.)

(c) *On Tissue Change and Nutrition in general.*

One of the first observations made as to the influence of increased air pressure was, that men who work in the diving-bell under the pressure of several atmospheres suffer a loss of body weight, which was the more noticeable when for any reason they could not obtain an increased supply of food. Under such circumstances the loss by combustion cannot be sufficiently replaced, and the consequent loss of body heat can only partly serve as evidence of the increased oxidation which has taken place during that time. It is natural to conclude, from the mechanical effect of raised pressure, that in this reduction of body weight stimulation of renal and alvine evacuation, as well as possible increase of aqueous evaporation through the lungs resulting from the enlargement of their vapourisable surface, must take a considerable share.

Simonoff and Sandahl have examined this question experimentally.

In Simonoff's thirteen observations, after a two hours' sitting with condensation of  $1\frac{2}{7}$  atmosphere, the body weight sank on an average about 207 grammes—minimum 130 grammes, maximum 250 grammes—while according to Sandahl the loss of weight after the several sittings fluctuated between 42.5 to 212.5 grammes. The average amount, 200 grammes loss of weight, does not diverge far from the average loss which the body suffers during a similar space of time in ordinary air, and therefore Simonoff does not venture to draw a conclusion as to the direct share which condensed air has in the reduction of body weight.

On the other hand Dr. Katschenowsky recently performed

experiments on himself and other persons in Simonoff's curative institute, in which the amount of food taken was limited to the quantity with which the body weight could be maintained at a constant level in ordinary air. He formulates the result of the series of his experiments in the following manner:—

1. With a quantity of food sufficient to maintain the balance between the absorption and excretion of the body in ordinary air, body weight steadily decreases under the influence of a daily two hours' sitting in condensed air. Similar results are no doubt obtained elsewhere.

2. The stimulation of the above-mentioned processes, absorption of oxygen and oxidation, must, if no other disturbing influences are present, increase the need for food in the animal body. So also, when the normal pressure is restored, the diminished amount of fluid in the animal body and the greater inspissation of the blood will excite active absorption in the stomach and intestine, in order to compensate as quickly as possible for the loss of water resulting from increase of the secretions and excretions.

Almost all observers have therefore mentioned as the immediate result of the action of compressed air in the pneumatic chamber a favourable effect on tissue change, and if the patient is allowed sufficient food, by the improvement of appetite resulting from the increased need, the absorption of the organism so much exceeds its excretions that body weight and muscular activity are increased by pneumatic treatment, while, on the other hand, diminished fat-formation and disappearance of fatty deposits were observed with appropriate food. The observations hitherto made on patients with regard to increase of weight under the influence of air compressed by  $1\frac{1}{4}$  to  $1\frac{3}{4}$  atmosphere yielded the following numerical results:—

According to Sandahl's notes, in the case of patients without fever, in 9 observations the body weight increased after 14 sittings on an average by 637·5 grammes, or after each sitting by 45·5 grammes.

J. Lange obtained in two observations after 38 sittings 5,000 grammes, or after each sitting 132 grammes.

Levinstein obtained in two observations after 30 sittings 1,875 grammes, or after one sitting 62·5 grammes.

V. Vivenot himself, after 110 sittings increased in body weight 1,250, or after one sitting 11 grammes.

Simonoff in 22 cases found after 21 sittings 1,114 on an average, or after each sitting 53 grammes, increase of weight.

The highest figures obtained were :—

In Sandahl's observations, after 300 sittings,	11,220 grammes ;
in Simonoff's	„ „ 30 „ 3,310 „
	and „ 90 „ 4,580 „

The results are different in patients when disturbances are present which either induce accelerated oxidation, as more or less violent fever and hectic fever, or which interfere in one way or another with the reception of food or its assimilation and absorption, as gastro-intestinal catarrhs and diarrhœa, or, lastly, which induce increased tissue change through muscular activity, e.g. voluntary and involuntary bodily movements, tonic and chronic muscular convulsions, hysterical attacks, &c.

In such cases, as may be foreseen, no increase of body weight will occur even after pneumatic treatment, but rather it will steadily decrease, and in proportion to the intensity of the disturbances which cause the increased consumption of matter in the diseased body. Here also Simonoff has furnished a series of observations, 19 cases, in which the decrease of weight could undoubtedly be referred to these causes, and in which the body weight was reduced by 786 grammes on an average after 21 sittings. Simonoff has also shown that in spite of such disturbances reduction of body weight may be avoided and even an increase of it obtained under the influence of compressed air. In two of his patients the body weight suffered no change during pneumatic treatment. In one case there was moderate fever ; in the other, that of a woman with hysteria, frequent and violent hysterical attacks took place ; in ten cases, on the other hand (7 of chronic pneumonia, 2 of purulent bronchitis, 1 of chronic bronchitis), in spite of the high fever which in two cases caused the temperature to rise to 39° C., an increase of weight was eventually gained.

The figures which express the gradually increasing weight under the influence of condensed air are not, according to Simonoff's observations, proportional to the number of sittings taken, but stand in inverse proportion to the duration of the

treatment, as their amounts are at first higher and gradually decline. Thus in the 22 patients without fever he obtained the following increase of weight :—

Average increase of weight in each person :—

Number of Sitzings	General Increase of Weight	Increase of Weight in 1 Sitting
2 ( 1 observation)	330·0 grms.	165·0 grms.
5 ( 4 observations)	567·5 "	113·0 "
7 ( 4 " )	715·0 "	102·0 "
10 ( 8 " )	847·5 "	85·0 "
11 (22 " )	1114·0 "	53·0 "

#### *Estimation of Urea.*

Few investigations have hitherto been published on the influence of compressed air on the secretion of urea. The estimations of urea made by P. Bert are valueless, even though the figures given by him show at a superficial glance a proportional increase of the amount of urea, because, without having previously brought the body to the nitrogen equilibrium necessary for these experiments, he undertook the sittings in the pneumatic apparatus and reckoned the quantities of urea obtained as the effect of compression of air.

Hadra states that he found a decided increase in the secretion of urea in a series of experiments. After he had brought the secretions of nitrogen into absolute equilibrium by a week's regulation of diet, he subjected himself in five sittings, four of them four hours long (from 9.20 till 1.20) and one three hours long (from 1.30 till 4.30), to the air pressure of two atmospheres in the pneumatic chamber, twenty minutes being allotted to the increasing, forty minutes to the decreasing pressure.

From the fifth day of his *régime* deviations of only 0·5 grammes in 31 were found in the excretions of urea, which gave a sufficient basis for these investigations: 5th day = 31·6; 6th day = 31·04; 7th day = 30·65; 8th day = 31·336; average = 31·156.

On the first day of increased pressure (9th day) he obtained = 32·417; 11th day = 32·947; 13th day = 34·973; 15th day = 32·486. If we reckon only from the fifth day under ordinary air pressure, and add together the results of all the days on which sittings were taken, and divide by the number of days in

Day of Month . . . 17-18 . . . 17-18 . . . 18-19 . . . 18-19 . . . 19-20 . . . 19-20 . . . 20-21 . . . 20-21 . . . 21-22 . . . 21-22 . . . 22-23 . . . 22-23 . . . 23-24 . . . 23-24 . . . 24-25 . . . 24-25 . . . 25-26 . . . 25-26 . . . 26-27 . . . 26-27 . . . 27-28 . . . 27-28 . . . 28-1 . . . 28-1 . . . 1-2 . . . 1-2 . . . 16 . . . 16 . . . 17 . . . 17

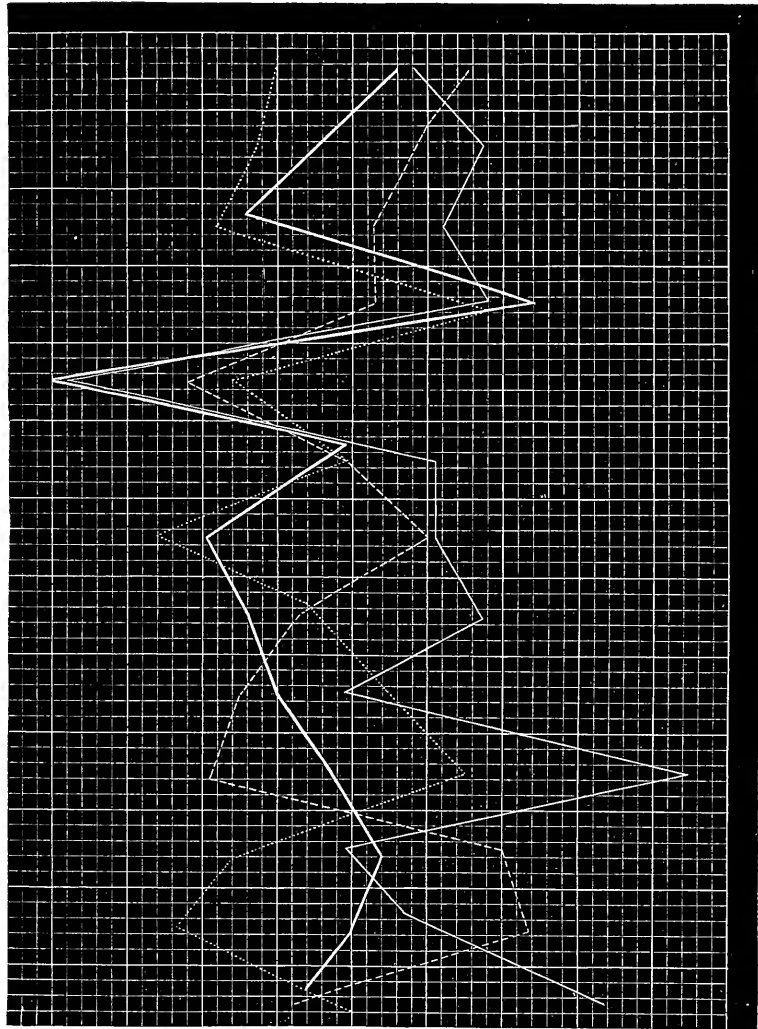

Quantity of Urine	Urea		Days
	Morn.	Aftern.	
2100	13	26	35
2100	12	25	34
2000	11	24	33
1900	10	23	32
1800	9	22	31
1700	8	21	30
1600	7	20	29
1500	6	19	28
1400	5	18	27

— signifies amount of urine; ———— daily amount of urea; - - - - - forenoon amount of urea; ..... afternoon amount of urea; 9, 10, 11, 13, 15 days of experiment.

each case, we obtain as average amounts: 30·835 under normal air pressure, and 32·977 under increased air pressure, therefore in the chamber an excess of 2·142. If we distinguish between the analyses of the urine voided in the forenoon hours (with four sittings) and of that in the afternoon hours (one sitting), and compare the estimates thus obtained with the sum total in the form of a curve, we find the singular result that, whereas in the days of equilibrium under normal atmospheric pressure no distinct relation of dependence is shown, from the beginning of the special experiments, during the whole nine days following, a very marked parallelism is recognisable between the afternoon quantity and that of the whole day.

Hadra feels justified in drawing from these facts the conclusion, that in this nine days' course, at the beginning of the influence of compressed air the afternoon amounts are the determining ones which decide the question, consequently that the effect of the compression of air does not show itself in an alteration of tissue change till after a certain time. This effect first showed itself in the urine voided after several hours, three hours as a minimum; it certainly did not last over twenty hours, as otherwise the forenoon amounts would not have fallen.

Hadra sees in the falling off of the forenoon amounts a diminution of tissue change, a phenomenon which indeed also occurred in the marked falling-off on the 14th day after the great excess, only in somewhat altered sequence. Hadra accounts for the mode of increase in the excretion of urea under the influence of compressed air by the hypothesis that his body, in consequence of the long duration of nitrogen equilibrium, was in a stable condition of nitrogen equilibrium, i.e. that it offered a great resistance to the influences at work, which the latter overcame only gradually but in larger measure daily. The compression then acting on the 13th day, after one day's pause, finds a considerably less tendency of the organism to maintain the nitrogen equilibrium; enormous excesses occur on the thirteenth and fifteenth days, as much as 3·8 grammes. The influence was at once evident in the forenoon; the equalisation continues over the whole following day, &c., and we find instead of stable only fluctuating equilibrium.

As we have as yet no indubitable evidence of the stimula-



tion of oxidating processes in the organism by the supply of larger quantities of oxygen (v.s. Oxygen), and Bert's amounts are not to be relied on, Hadra does not venture to decide definitely the question whether the increased secretion of urea is dependent on an increased combustion of albumen in the body. According to the proportion of oxygen contained in it, air compressed by two atmospheres will behave in the same manner with regard to its activity as air under one atmosphere with double the amount of oxygen. Compression seems to him useful so far that it induces a general expansion of the lungs, as evidenced by the diminution of cardiac dulness, displacement of the boundaries of the lungs, increase of vital capacity, compression of the intestinal gases and depression of the diaphragm, thus facilitating the exchange of gases. It is worthy of special remark that Hadra in his experiments did not find the quantity of urine voided during the time of experiment increased, and could not therefore attribute the large amount of urea found to the excretion of a larger quantity of water. If the last observation, that compressed air does not increase the amount of urine, is confirmed by further investigations, the theory of Simonoff and others on the circulatory changes under compressed air loses its principal support.

Unfortunately the results announced here as to the effect of compressed air on tissue change, especially the nitrogenised tissue, has been recently called in question again by the researches of A. Fränkel, who under a pressure of two atmospheres, lasting through many hours, failed to detect any influence on the excretion of urea in the dog, and attributes Hadra's divergent results to certain defects in his method. These differences must be left to future experimenters to decide.

*(d) Influence of Improved Nutrition on Muscular Force and the Elasticity of the Lung Tissue.*

With the improvement of nutrition, as shown in various patients by increase of body weight, it has been sought to associate an increase of muscular power and of the elasticity of the lung tissue.

J. Lange has made the force of the muscles of the arm the

subject of examination in two persons, and has observed a steady increase of the supporting power of the horizontally outstretched arm under augmented excess pressure by an increment of 100 to 100 millimetres (from  $\frac{1}{8}$  to  $\frac{1}{8}$  atmosphere); the gain was on an average 0.4 to 0.6.

In eleven persons who remained two hours in air of  $1\frac{2}{7}$  atmosphere pressure Simonoff found that the strength of their finger muscles after 20 sittings had gained on an average four kilogrammes of Charrière's hand dynamometer. Still more remarkable was the increase in strength of the respiratory muscles, as was ascertained by Pravaz and J. Lange by the rise of the mercury column in the manometer during expiratory pressure and its sinking during the inspiratory act. But most of the patients who were treated in the pneumatic chamber immediately also experienced the feeling of increased bodily activity, and Pol and Foley have repeatedly called attention to the unusual ease of muscular movements and the absence of fatigue in workmen under the influence of compressed air. Lastly, J. Lange has endeavoured to prove experimentally that the increase of muscular strength which could be observed in the persons under experiment during and after the air bath was not the result of gradual exercise, but due to the influence of compressed air or tissue change dependent on the increased absorption of oxygen.

Finally, as regards the increased elasticity of the lung tissue, attempts have been made to account for it, as has been already mentioned, by increase of the muscular force of the respiratory muscles and the consequent greater mobility of the thorax, especially by the improved nutrition of the lungs themselves. In opposition to this theory Knauthe refers the increased elasticity of the lung tissue rather to the alternate influence of rising and declining air pressure on the superficial and deeper-lying tissues; the rising pressure and the constant pressure lasting the rest of the time in the chamber, effects a mechanical expansion of the lung, while the steady rarefaction of the air in the chamber by the decreasing pressure, like expiration into rarefied air by means of the transportable apparatus, mechanically promotes its retraction. Knauthe regards the mechanical action of compressed air in the chamber as chiefly pressure-

equalising, by which also the secondary effect announced by observers, and the habitual permanence of the increased lung capacity, the increase of pneumatometric estimates and easier respiration, &c., became comprehensible.

In addition to the above-mentioned effects of compressed air a soothing influence on the nervous system and promotion of sleep are also attributed to it.

### ACTION OF PRESSURE IN PASSING FROM A DENSER TO A RARER AIR.

It still remains for us, in describing the mechanical influence of air pressure on the organism, to examine the manner in which the diminution of the raised air pressure will influence the organs and tissues changed by compression.

Even a tolerably rapid increase of air pressure is not particularly felt except in the frequently painful pressing in of the tympanic membrane and the tendency of the above-described symptoms to appear more rapidly than is generally usual, especially a more rapid decrease of respiratory and pulse frequency, also a diminution in the calibre of the superficial arteries, as the radial artery, which are less easily felt. In Bert's experiments the animals bore a rise of ordinary air pressure to five atmospheres in a few minutes without injury, but were killed by a rapid increase of the pressure to seven atmospheres.

It is different with changes of pressure in an inverse sense, in too sudden a transition from high to low degrees of pressure. In this case the body is not in a condition to equalise the suddenly produced difference of pressure without injury, and the consequences are active congestions to the skin, skin irritation, muscular pains resembling rheumatism, which it was attempted to explain by liberation of oxygen gas (v.s.) The face becomes intensely red, the pulse hard, full, and frequent; cardiac action is increased; the patient breathes hard and noisily; dyspnoea and attacks of suffocation occur, while at the same time hæmorrhages from the ear, nose, mouth, and lungs appear; delirium, giddiness, vomiting, fainting, trismus, dysuria, paraplegia, coma, and even death may supervene (François, Pol,

Foley, and others). The group of symptoms resulting from the too sudden removal of the increased atmosphere pressure resting on the body have been designated 'Entschleussung' symptoms, perturbatory disturbances. They occur principally in mines in which the water has been forced back by air pumps from the shaft and the galleries, as well as in building piers of bridges in compressed air, where the condensation of air to which the workmen are subjected often amounts to 4 to 6 atmospheres excess pressure. Such cases have been also observed in sponge fishers at the bottom of the sea, when they, provided with divers' apparatus, have come up too suddenly from a great depth.

Hoppe-Seyler attributes the paralyses and the sudden death to the development of nitrogen gas within the great veins, obstruction of the pulmonary capillaries by gas bubbles, and arrest of the propelling action of the heart on the blood, as the gas is compressed by the heart in each contraction and dilated in each systole, without being driven into the arteries like the incompressible blood answering to the systolic reduction of the heart's capacity. These two causes induce sudden stoppage of the circulation, and thereby death. Leyden and Schultze found in workmen who, after too sudden a transition from a high to a considerably lower atmospheric pressure, had suffered paralytic affections of the spinal cord and succumbed to them, that the phenomena had arisen from fissures in the substance of the spinal cord. These fissures were not caused by hæmorrhages resulting from vascular ruptures, but in passing into rarer air by the sudden liberation of gas bubbles and their penetration into the substance of the spinal cord.

While Hoppe-Seyler first ascertained experimentally in animals the connection between this development of gas in the blood and the cessation of life, Bert has not only confirmed this, but also found that the gas which here occurs in the blood contains 90 vols. per cent. of nitrogen, and in cases where animals were introduced into very strongly compressed air the blood drawn from them by venesection foamed under a lower atmospheric pressure. If such animals were to be kept alive after their introduction into highly compressed air an exceedingly slow and cautious diminution of the air pressure

had to be carried out after the experiment, so that the excess of the absorbed gas might escape from the blood by diffusion into the pulmonary air. Pol and Foley also recommend as the only remedy against the perturbatory symptoms observed in the human subject, speedy return to increased air pressure, followed by an exceedingly gradual transition to lower and lower and finally to ordinary atmospheric pressure.

These dangerous 'Entschleussung' symptoms have not hitherto been observed under the moderately compressed air employed for therapeutic purposes in the pneumatic chamber, under the constant supervision of a person thoroughly familiar with the apparatus and with possible casualties.

## THERAPEUTIC USE OF COMPRESSED AIR IN THE PNEUMATIC CHAMBER.

### INDICATIONS AND COUNTER-INDICATIONS.

The therapeutic use of compressed air is really limited to a small class of diseases, notwithstanding the possible extension which theoretical considerations would give it, and if we go beyond these indications it is with the view of showing in what various ways it is possible to utilise the action of the pneumatic chamber. These indications have, however, been greatly limited either by the concurrence of other and better therapeutic methods or by the disproportion between the expense attending this treatment and the advantage to be derived from it.

The employment of compressed air in this form is only appropriate when its action cannot be obtained in the same degree by any other curative procedure, or when it is at least equivalent to some other, but possesses, in addition, some kind of special advantages or valuable secondary effects. Thus the class of diseases suitable for treatment in condensed air in the pneumatic chamber will be a small one, but its therapeutic value will thereby be enhanced.

According to the manner in which compressed air acts on the body in the chamber we obtain different indications for its use, according as we desire to develop preponderatingly the effect of one or other mode of action; at the same time of course the influence of the others, which it is impossible to exclude, may

be regarded as aiding or at least not interfering with the desired therapeutic result.

The general indications for the use of compressed air in the pneumatic chamber are therefore furnished by its mode of action, which is twofold :—

1. A purely mechanical, simple pressure action, which differentiates itself according to the object submitted to it and the changes it produces in it—

(a) As blood-displacing and anti-hyperæmic, in acute and chronic inflammatory conditions of the tissues directly exposed to the pressure, on the mucous membranes of the whole respiratory tract, then in similar changes in the lungs, on the mucous membrane of the eye, of the female sexual organs, and on the external skin ;

(b) As secretion-limiting and anti-catarrhal, in increased secretion resulting from catarrhal processes in the above-named mucous membranes ;

(c) As promoting absorption of inflammatory infiltrations and exudations in and on these mucous surfaces as well as in the lungs and the pleural sacs. Compressed air acts further—

(d) By condensing the tissues on which the increased pressure acts, and thus raising their consistency and tone ;

(e) By furthering the flow of blood towards the organs less exposed to the pressure, and consequently improving the nutrition of those parts, especially the bones, the muscles, the kidneys, the ovaries, the uterus, as well as the organs in the vertebral canal and in the abdominal cavity, whereby at the same time—

(f) A stimulation of the secretion and excretion of the local glandular organs is effected ;

(g) By lowering cardiac activity and blood pressure ;

(h) By increasing the lung capacity, by stronger expansion and retraction of the lung tissue, as well as by restoring perviousness to pathologically occluded air passages.

2. The action of inspirations of condensed air in the chamber is also attended by the excitation of chemico-physiological processes, which facilitate the removal of morbid changes in the organism—

(a) By increased absorption of oxygen in the lungs and improvement of the quality of the blood ;

(b) By increased oxidation ;

(c) By accelerating tissue change and promoting muscular strength.

Residence in the pneumatic chamber is counter-indicated—

1. In weakness of the cardiac muscle, the presence of myocarditic symptoms which lead to insufficient cardiac activity ;

2. In renal diseases, parenchymatous inflammations of the kidneys, which are aggravated by increased afflux of blood and by venous engorgement ;

3. In affections of the spinal cord which are also aggravated by increased afflux of blood ;

4. In hyperæmia and congestion of the intestinal canal, ovaries, and uterus, in hæmorrhages of the latter resulting from local disease ;

5. In high fever with a rise of temperature above 39° C., especially in pulmonary affections, and lastly in hectic symptoms, which wholly counter-indicate this treatment.

#### (A) EMPLOYMENT SPECIALLY OF ITS MECHANICAL ACTION.

##### 1. IN ACUTE AND SUBACUTE INFLAMMATIONS OF THE RESPIRATORY MUCOUS MEMBRANE.

If I were to be asked what remedy or what therapeutic procedure I considered the most efficacious in acute catarrhal inflammations of the respiratory mucous membrane, or of the mucous membranes directly exposed to the external air, I should unhesitatingly give the preference to the employment of the compressed air chamber. We possess no remedy equal to it for antagonising the hyperæmia, hypersecretion, and softening of the distended surfaces of the mucous membrane in the stage of catarrhal irritation, without itself acting as an inflammatory excitant.

As I have already repeatedly observed in the chemical part of this manual, anti-hyperæmic, astringent, and other remedies of the same character are not tolerated in this stage of inflammation of the mucous membrane ; but we must confine ourselves to the application of warm aqueous vapours, mucilaginous and protective substances, and it is not till this stage is over that we can arrest the pathological processes by those medicaments

The uniformly increasing pressure, rising finally to  $1\frac{3}{7}$  atmosphere of pure air, acting on the inflamed tissues, is felt by the affected mucous membranes as so mild and non-irritant in its influence that its complete antiphlogistic force may be developed even in an irritated condition of the mucous membranes. It would therefore be only rational if these forms of inflammation were especially submitted to this mode of treatment. But, owing to a number of purely external reasons, the difficulty which sometimes exists of procuring this remedy, as well as the possibility that the practitioner may obtain the desired result by some more accessible method, the employment of the pneumatic chamber in these affections has not become general.

#### *Acute Laryngeal and Bronchial Catarrh.*

According to the observations hitherto published, the pressure action of compressed air on the catarrhally inflamed mucous membrane succeeds in a short time in removing the acute hyperæmia and swelling and in limiting the secretion, while the irritative cough and dyspnoëic symptoms, when present, diminish gradually with the retrogression of anatomical changes.

Catarrh of the larynx and trachea, as well as of the larger and smaller bronchi, reacts in the same manner to the mechanical influence of the pressure; the age of the patient makes no essential difference, and it is only when at the same time changes in the lung tissue, dilatation of the pulmonary vesicles are present, and the process has assumed a subacute character, that a more frequent repetition of pressure action will be necessary than is the case in simple acute inflammation.

In a case of Bertin's, in which acute bronchitis was cured in one sitting, all morbid symptoms had disappeared even during the sojourn in the apparatus, soon after the level of constant pressure had been reached, an hour after the commencement of the sitting. In the case of children, in whom the continual recurrence of bronchial catarrhs threatens the early development of emphysema and asthma, Liebig considers the employment of increased air pressure highly valuable. J. Lange advises the continuance of pneumatic treatment even after the



removal of bronchial, especially capillary, catarrh, to obviate relapses and avert sequela. The observations of Simonoff, Pravaz, and others are in entire accordance with those of Lange on this subject.

The number of sittings necessary for the removal of an acute catarrh of the respiratory mucous membrane may be fixed on an average at 3 to 4. The minimum, according to the observations before us, was 1; the maximum amounted to 12 to 15 sittings; the duration of the illness and the individual behaviour of the patients in themselves modified the amount.

## 2. CHRONIC AFFECTIONS.

With regard to chronic inflammations of the mucous membrane of the upper parts of the respiratory tract, of the nostrils, the pharynx, the larynx, the conditions are far more unfavourable for mechanical influence of compressed air than is the case in acute inflammations.

In the majority of cases the pathological changes of the mucous membranes have already advanced to a degree which requires far more energetic treatment to obtain any real result. A chronic coryza, a chronic pharyngeal catarrh, offers so active a resistance to the most aggressive local treatment that these maladies have hitherto been reckoned among the most discouraging to the physician, and it is only quite recently, when the practice began of destroying the extensive hypertrophies, the granulations and follicular swellings in the mucous membrane radically with the galvanocautery, that more favourable results have been obtained.

The same may be said of chronic catarrh of the larynx. Here also the extensive changes in the mucous membrane offer so successful a resistance to treatment that their cure can only be effected by active local measures. I am much inclined to question whether laryngeal ulcers undergo any changes under the influence of condensed air, and improvements effected by it, supposed to have been observed by some persons with the laryngoscope, still stand in need of reliable confirmation from other quarters. It will therefore be well either to leave these affections entirely outside the region of pneumatic treatment, or

else to proceed cautiously and with repeated examination of the existing changes of the tissue, so as not to throw discredit on this method of treatment by employing it in unsuitable cases. Thus I have witnessed the case of a young clergyman who spoke hoarsely in consequence of a fibroma of the right vocal cord treated for months in the pneumatic chamber, naturally without success. So also the chronic affections of other mucous membranes, those of the eye, of the tubes, of the vagina, of the uterus, should not be submitted to pneumatic treatment without careful examination, and when the cases are doubtful it is better to reject them at once and avoid the disappointment attending failure. Unfortunately many mistakes of this kind have already been committed, and the credit of many a curative institution has been injured in the eyes of the experienced practitioner and even of the public.

(a) *Chronic Bronchial Catarrh.*

Chronic catarrhal inflammation of the bronchial mucous membrane, which is of far more sensitive and delicate structure and texture than the pharyngeal and laryngeal mucous membrane, and therefore reacts more vigorously to external influences, presents one of the most favourable pathological objects for treatment in the pneumatic chamber. The congestion of the bronchial mucous membrane is reduced by the increased pressure to which it is submitted; the swelling and softening of the mucous membrane is diminished by the compression of the condensed air, by the diminished exudation of blood serum from the vessels, and by the propulsion of the lymph out of the lacunæ of the tissues into the lymphatics, by which means also the secretion is checked. By the same mechanical changes the exchange of air in the lungs is also increased, and by this and the greater supply of oxygen the dyspnoea generally present and the defective decarbonisation of the blood are removed. Tissue change is also vigorously excited, and the nutrition of the patient, frequently defective, is soon perceptibly improved, the nervous excitability and reflex activity lowered, and the cough relieved.

If the chronic catarrh is complicated with other pathological processes the result of pneumatic treatment will depend on the

gravity of the disturbances encountered. Unfortunately these complications are present in the great majority of catarrhal bronchial affections, and originate on the one hand in the bronchi, on the other in the lungs and the heart, with or without consecutive changes in the walls of the chest.

We must therefore distinguish—

1. Uncomplicated chronic bronchial catarrhs ;
2. Chronic bronchial catarrhs with advanced changes of the bronchial wall itself, bronchiectatic dilatations, and
3. Chronic bronchial catarrhs with dilatation of the pulmonary vesicles without consecutive change of form in the thorax ;
4. With distension of the pulmonary vesicles and dilatation of the right ventricle, or generally complicated with organic disease of the heart, and lastly
5. Bronchial catarrh with pulmonary emphysema and consecutive changes of the thoracic walls.

The mechanical action of increased atmospheric pressure and its therapeutic effect on the chronically inflamed bronchial mucous membrane is in the first place dependent on the question, With what other maladies and to what extent is the chronic bronchitis complicated ?

The influence of condensed air is most rapidly and most completely displayed in those cases in which there is bronchial catarrh only, or, if partial emphysema is present, there is no consecutive change of the thorax. Where together with emphysema there is obstruction of the pulmonary circulation, caused by dilatation of the right ventricle and other defects of the heart, the result of pneumatic treatment is far slower and more doubtful ; on the other hand, however, the attacks of suffocation and orthopnœic symptoms resulting from this complication are most speedily removed under the influence of condensed air ; so that the patient, exhausted by persistent dyspnœa, recovers himself completely after half an hour spent in the chamber, and after long sleeplessness is perhaps able to go to sleep for the first time. Where, lastly, the complications we have just mentioned have been set up with consecutive changes of the thorax, it is easy to understand that even the palliative effect obtained by pneumatic treatment will be only slight, and

the number of sittings necessary for successful results must far exceed those in other cases.

An observation mentioned by Simonoff shows the powerful influence which compressed air is capable of exercising in cases of the most violent orthopnoea due to complications of pulmonary emphysema and cardiac affection. The patient in question, an old man of eighty, was brought to Simonoff's establishment, with the request that he might be placed in the apparatus at once. He was apparently at the last gasp; the frightful emaciation, the bluish cadaveric colour, the head sunk upon the breast, the closed eyes, the morbidly feeble respiration, which ceased from time to time, the hardly perceptible, intermittent pulse, lastly the almost total insensibility to all that went on around him, all seemed to announce the speedy approach of death. It was found by examination in the apparatus that the patient suffered from chronic bronchial catarrh and emphysema with thoracic deformity and considerable dilatation of the right ventricle. The lungs were evidently œdematous throughout. Orthopnoëic conditions had been in existence more than two months, but the patient had been in this hopeless state only a few days, during which he ate scarcely anything, and was therefore exhausted to the utmost. On the urgent request of the relations of the patient for immediate application of condensed air, partly also out of curiosity, Simonoff received the patient into the apparatus. In proportion as the condensation of air increased in the apparatus the patient visibly revived: first the convulsive and intermittent character of the breathing disappeared; it became deeper and proceeded regularly and without interruption. At the same time the pulse became more distinct, the eyes opened, the head was raised, and the patient began to speak. His first request was for something to eat. A piece of cold beefsteak and a glass of red wine raised the strength so much that an interruption seemed feasible; at the same time the patient talked continually. Towards the close of the sitting, when the air was again rarefied to the normal, his condition became worse; however, he remained conscious and breathed better than before the sitting. Towards evening he fell again into a state of unconsciousness. The following day the patient was again brought to the establish-

ment, and the same process was repeated. After the third sitting the patient returned no more; probably he was dead.

The number of sittings which are necessary on an average for the cure of a chronic catarrh, with or without partial emphysema, may be fixed at about 40; where emphysema and cardiac disease co-exist the cure requires far more sittings, 50 and over, while with diffuse emphysema and changes of the thorax 100 sittings and more may become necessary to remove the existing bronchial catarrh. Finally, patients who suffer from incurable dilatation of the pulmonary vesicles, in order to enjoy a relative amount of comfort, must submit from time to time to repeated pneumatic treatment, best during the cold season, when the conditions for the development of diffuse bronchial catarrh are most favourable.

(b) *Pulmonary Emphysema.*

Since the construction of pneumatic chambers pulmonary emphysema has been especially the object of therapeutic experiment with compressed air, and the possibility of its retrogression under the influence of compressed air has been repeatedly brought forward.

The favourable results which were obtained arose more especially from more or less complete removal of the complications which make the malady so distressing to the patients—subacute and chronic bronchial catarrhs, difficulty of breathing, &c. It is certain that the considerable relief which patients experience from treatment in the pneumatic chamber makes this disease specially suitable to this treatment, and in the reports of the pneumatic establishments the statistics of the curative results obtained were almost always very high. Simple pulmonary emphysema is now regarded by those who consider that they possess in the pneumatic chamber a radical and not a merely palliative remedy as completely curable, but complications with cardiac affections or other organic changes materially reduce the result, or even prevent it altogether. Among the complications of this latter kind are reckoned laryngeal and pharyngeal catarrhs with granular proliferations, which, by constantly keeping up coughing and irritation to coughing, make a complete recovery impossible. The earlier observers (Pravaz, Sandahl, Brünniche, G. and J. Lange, and

others) were far more convinced of the possibility of radically curing these pathological changes of the lung tissue than those who now occupy themselves with the question. V. Vivènot says that he has repeatedly found vesicular breathing where it was not to be detected before the treatment; but Devay stands alone in maintaining that he has not seen a single case of cure of this disease by means of condensed air.

According to the view of some of these observers the process by which pulmonary emphysema is cured under the influence of compressed air is as follows:—

In the first place, after even a short sojourn in condensed air, the respiration becomes easier, slower, and the inspirations deeper; the lungs become more expanded and larger quantities of oxygen are conveyed to them. The next result would be that the respiratory difficulties of the patient would at once diminish, dyspnoea and cyanosis gradually disappear, and general relief and subjective comfort set in. But if the lungs should be subjected for a longer time to the action of compressed air the vital capacity would gradually increase, the inspiratory and expiratory pressure would be raised, the vital average position of the lungs would come nearer to the position of deepest inspiration, and more oxygen would be permanently conveyed to them. After a longer use of compressed air the tone of the tissues would be raised, and thence would result an increased elasticity of the lungs.

Unfortunately the proof of this last theory is not yet forthcoming, and cannot be deduced with convincing exactitude from the above-mentioned effects. V. Liebig endeavours to refer the influence of compressed air in the chamber in emphysema partly to an increase of the elasticity of the lung tissue, the so-called elastic secondary effect, partly to the increased circulation of blood in the lungs, as a result of the enlargement of the blood channel by the facilitation of respiration under increased pressure. Although a strict confirmation of v. Liebig's first theory is as yet wanting, it must not, on the other hand, be forgotten that the pathological changes of the emphysematous lungs depend partly in the first instance on disturbances of nutrition of the lung tissue, which lead eventually to obliteration of the capillaries and gradual atrophy of

the alveolar walls. Since now in compressed air the blood supply in the lung itself is increased, these disturbances, if they have not advanced too far, can by the abundant flow of blood into the capillaries and improvement of the nutrition be gradually compensated. Simonoff also refers emphysema to disturbances of nutrition of the lung tissue, so that it cannot be removed by purely mechanical means. He is of opinion that the condensed air in the chamber cures or improves emphysema, because it promotes the nutrition of the body generally and especially of the lung tissue, and also because it removes its original causes, bronchial catarrhs, atelectasis of the tissue, fits of coughing, and dyspnoea, &c.

It must depend on how far the changes of tissue in the lungs, decrease of elasticity, inflation of the air cells, obliteration of the alveolar walls, development of ectasis, have already advanced, whether there is a possibility of inducing a retrogression of these processes by the mechanical or chemico-physiological influence of compressed air. The mechanical action of raised pressure, as we have already demonstrated elsewhere (v. supra), does not remove the physical lesions which characterise emphysema; the lungs do not show any retraction under it, but are even more dilated, while the expiratory insufficiency of the emphysema receives no relief from condensed air, since, while inspiration becomes deeper, expiration becomes shorter and more difficult. It is not till under diminishing pressure, in the streaming out of expiratory air from a denser into a rarer medium, when the skin and the peripheral mucous membranes receive again an increased blood supply, that the previously dilated lungs become retracted, and continue so till the body again finds itself in full equilibrium under normal air pressure. The steadily decreasing pressure of the surrounding air in the chamber acts here analogously to expiration into rarefied air, and so there is in a certain sense a possibility of an increase of elasticity of the lung tissue under treatment in the pneumatic chamber. Since, however, on return to normal air pressure a retraction of the inflated lung tissue to its previous volume by means of this equalisation of pressure and a free outpouring of the more or less accumulated residual air in the dilated air cells does not occur, the mechanical effect

of air pressure in the pneumatic chamber with regard to the increase of elasticity of the lung tissue is not of very great value and cannot supply a basis for radical influence on the changes in pulmonary emphysema.

The duration of the treatment must be determined by the nature and diffusion of the pathological changes in the lung tissue and the complications, and embraces on an average 30 sittings in simple vesicular emphysema, in order to obtain, if not a radical cure, at least a general alleviation, while, according to the nature and gravity of the complications, a course of treatment extending over several months may become necessary to effect a palliative, symptomatic, curative influence.

(c) *Bronchial Asthma.*

According to the observations hitherto published, asthma yields to the influence of compressed air all the more certainly the more the attacks are dependent on acute swelling of the bronchial mucous membrane.

The action here is chiefly anti-catarrhal—dislodgment of blood from the hyperæmic parts, compression of the swollen mucous membrane, mechanical dilatation of the bronchi and of the lungs themselves by the increased pressure, while at the same time a larger amount of oxygen is conveyed to them and absorbed into the blood. Where the attacks are more dependent on the nervous system the influence of the chamber is slower, less sure, or generally fails entirely, like every other remedy. Simonoff places half-way between these two forms of asthma that form of asthma induced by uterine diseases.

In most cases of asthma it is difficult to estimate the action of condensed air with regard to the complete and permanent removal of the malady, as the disappearance of the symptoms recognisable by physical examination, pulmonary rhonchi, &c., and the suspension of asthmatic attacks in the course of a certain time only testify to a more or less important alleviation of the malady, but by no means ensure a complete and lasting cure of the disease or exemption from recurrence of the attacks.

It is observed in general that by the use of the pneumatic chamber the asthmatic attacks occur at longer intervals and with diminished force, and also that in cases where the fre-



quency of the attacks is not decreased an alleviation and shortening of the paroxysms are at least obtained during the residence in condensed air and immediately after it.

The number of sittings may extend from 10 to 60, 80, and even more.

*(d) Diseases connected with Pulmonary Consumption.*

Of all pulmonary affections those which are connected with phthisis present the strongest indications for the employment of compressed air, and it is necessary to reiterate this fact, as it is not yet fully accepted even on the part of physicians.

I believe a well-devised treatment by change of air pressure, especially in the pneumatic chamber, to be of far more importance in the different stages of this disease than a great number of climatic and other curative methods on home and foreign mountain heights and valleys, the rational basis of which can unfortunately seldom stand the test of close criticism.

We possess no mode of treatment capable of antagonising these pathological processes in so many ways and so effectually as compressed air in the chamber, and even though the statistics of the reports hitherto published leave room for improvement and completion, there is no doubt that by general, early, and long-continued treatment we shall yet obtain far more favourable results; on the other hand we may be perfectly satisfied with obtaining improvement of the local processes and alleviation of the subjective symptoms in cases in which no other method has hitherto succeeded in producing the same effects. It is important that this well-founded opinion should be more widely spread among physicians as well as patients.

The mechanical and chemico-physiological effects of compressed air—e.g. the expansion of the lungs, the elevation of inspiratory and expiratory pressure, the increase of the depth of the inspirations and of vital capacity, the augmented supply of oxygen, the widening of the blood channel and the consequent better nutrition of the lungs—are useful in various ways, and receive their definite and unmistakable indications from the several pathological phenomena of the various morbid processes in course of development.

According to the form and progress of the particular case, pneumatic treatment of the affections comprehended under the expression pulmonary phthisis may be prophylactic, radical, or symptomatic. The favourable influence of increased atmospheric pressure is not only observed in the organ chiefly affected, the lung itself, and in the pathological changes of the respiratory and circulatory system, but the whole body and its physiological functions are accessible to its influence in a greater or less degree.

Accordingly the indications are—

#### 1. *The Phthisical Habit.*

In order to antagonise pulmonary phthisis it is desirable to alter as early as possible the conditions favourable to its development, so as to prevent the development of chronic inflammatory processes. Pneumatic treatment is here chiefly prophylactic, but not exclusively so, for since it aims at restoring to the normal the defective development and strength of the body and the various organs it is also symptomatic and radical.

The long, narrow, shallow thorax, more or less flattened in the infraclavicular region, with impaired mobility and expansibility in its upper part, under the mechanical influence of compressed air and improved nutrition of the inspiratory muscles acquires increased inspiratory expansion; the feebly expanded, anæmic, and vulnerable lungs become more or less dilated; the inspirations, previously superficial and frequent, become deeper and fewer; the inspiratory and expiratory pressure are raised, and the vital capacity thereby increased, while, what is of special importance, the anæmic lung tissue itself is better nourished by enlargement of its blood channel and gains in elasticity and power of resistance.

The general nutrition and sanguification, usually defective, are ameliorated, and the development of the individual is aided by improved muscular tone and vigour.

Physical examination of the chest and the rise of the spirometric and pneumatometric figures, as well as the increase of body weight, are evidence of progressive improvement from this treatment.

The duration of the treatment, which must always in these cases be protracted, will have to be determined by the results of these examinations. Thorough physical examination and consideration of the hereditary conditions will alone decide up to what age prophylactic treatment may be carried out with such individuals, which will be found more urgent in one case than another. The earlier it is possible to begin mechanical treatment of the thorax and lungs in the pneumatic chamber, the more favourable will be the results.

## 2. *Catarrh of the Apex and Peribronchitis.*

The first physically detectable inflammatory processes in the apices of the lungs call for comprehensive employment of the pneumatic apparatus, to the action of which they are far more amenable than to all our other therapeutic methods. Left to themselves, they generally run a most unfavourable course, and in a longer or shorter time they develop into all those forms of phthisis and tuberculosis which ultimately lead to a fatal issue.

The anti-catarrhal influence of increased pressure is here especially called into action, the congestion and the secretion of the hyperæmic tissue are limited, the softening and swelling are reduced by mechanical compression, and by their consequent thickening the tone of the tissues is raised; the collapsed and partially obliterated alveoli at the apices of the lungs become inflated and made permeable to air; expectoration is facilitated, the cough diminished by the abatement of the inflammatory irritation in the bronchi, with concomitant progressive improvement of the subjective and objective symptoms.

In the majority of cases there is little or no fever, a temperature perhaps from 38° C. to 38·5° C., but a more marked increase, or even a temporary elevation to 39·5° C., will not counter-indicate the use of compressed air, but as a rule the fever will abate and disappear rapidly under the influence of the treatment and parallel with the retrogression of the local changes.

If the object in such cases is to effect improvement and cure

of the existing, physically detectable processes in the apices of the lungs, the strictest control and repeated action of the pressure on the lungs are necessary for a long time, partly to prevent the insidious relapses of these processes, partly to maintain the expansion of the apices of the lungs and the increase of respiratory capacity already gained. In this sense pneumatic treatment may be prolonged for several years as a prophylactic.

3. *Chronic Parenchymatous Inflammation of the Lungs, Chronic Desquamative Pneumonia.*

The conditions assume a far more unfavourable form when these processes have once been developed in the lungs; and although a series of observations in which a radical cure has been effected have been recorded, these are after all only exceptional cases; in the majority of cases we must content ourselves with obtaining a modification of the course of the malady, a temporary limitation of the local processes, and a mitigation of the symptoms.

Here, again, in the first place it is the influence of mechanical pressure action on the inflamed tissues which brings about a diminution of the subjective and objective troubles. The pressure, by abating the hyperæmia and swelling, lessens the cough and the attendant bronchial catarrh; the respiration is gradually facilitated, the lung more and more expanded, the inspiratory and expiratory pressure raised, the inspirations deepened, and the vital capacity perceptibly increased. While the oxygen required for tissue change is again conveyed to the body in abundance and nutrition improved by suitable strengthening diet and controlled by observation of the increase in weight, in the lungs themselves, by the simultaneous improvement of their nutrition and tissue change, due to the enlargement of their blood channel and the abundant supply of new formative material thus obtained, and the discharge of effete substances and decomposed and exudative products, conditions are created which must have a favourable influence on the chronic inflammatory processes and their resolution. In fact after some time a retrogressive change of the local affection

of the lung tissue may be ascertained; the dulness of the apices of the lungs diminishes perceptibly or disappears entirely (Simonoff), either on both sides or principally on the side which was least affected at first; the crepitant râles are also fewer or vanish altogether, while in places where bronchial respiration previously existed fine rhonchi occur, and these may also disappear under continued treatment.

The improvement in the general state of health and the increase of body weight are universally admitted to be effects of the pneumatic chamber. The figures published by Simonoff of the increase of body weight under the influence of compressed air are partly taken from the observation of such patients.

The result of the treatment is chiefly influenced by the degree of fever that exists. Where there was no fever, or where it was but slight, the daily maximum not exceeding  $38.5^{\circ}$  C., a considerable improvement was always observed in Simonoff's cases, and complete recovery in one-third of them. With a moderate amount of fever, daily maximum  $39^{\circ}$  to  $39.2^{\circ}$  C., complete recovery was doubtful (not once observed by Simonoff), and a considerable improvement relatively rare (in one-fourth of the cases). High fever, with a daily maximum of  $40^{\circ}$  C. and more, aggravates the unfavourable prognosis, although even here those symptoms which are most distressing to the patient—cough, dyspnoea, exhausting perspirations—are generally alleviated; in quite exceptional cases even a more or less considerable improvement of the local process has been observed. But the fever has no such prognostic significance when it is a transient symptom, but only when it recurs daily with a certain severity. The occurrence of moderate or even considerable fever in patients hitherto without fever, the onset of slight fever for a short time has no such influence on the course of the malady; any considerable improvement or complete recovery will certainly be retarded by it, but not made impossible. The persistence of moderate but especially of high fever generally indicates that the process is advancing more rapidly, and is in most cases a sign of tuberculous deposit not only in the lungs, but also in different other organs of the body. In such cases there is no possible hope of any appreciable improvement, and Simonoff has recently declined to receive

into the hospital patients in whom chronic inflammation of the lungs is attended with daily recurring fever rising above  $39^{\circ}$  C.

4. *Lobular Caseous Inflammation of the Lungs and Bronchopneumonic Ulceration*

do not yield the relatively favourable results which we may look for in the preceding processes. We must be satisfied with being able to act somewhat on the symptoms. In most cases the fever is always considerable, the temperature keeping about  $39^{\circ}$  to  $40^{\circ}$  C.; the patients are anæmic and more or less emaciated, while the infiltration is diffused over one to two thirds of both lungs, and frequently scattered patches of inflammation extend still farther, while generally there are found larger or smaller patches of softening.

Even these advanced changes in the lungs, as Simonoff has shown, do not counter-indicate the use of increased pressure, provided the fever is kept within those limits which is one of the conditions of success in the treatment of the preceding forms of phthisical disease. The favourable influence of compressed air will, however, be only brief and temporary, and will seldom do more than alleviate individual symptoms. In twelve cases of Simonoff's, which were attended with high fever, the cough and dyspnœa, as well as the general feeling of illness, were mitigated during the treatment; the fever, however, persisted and the process advanced gradually. In two cases without or with only slight fever the objective symptoms also improved under the treatment, the dulness decreased, the crepitant râles were lessened or even disappeared altogether, but the appearances showed no stability, changed perpetually during the whole duration of the treatment, and at the close of it, in spite of the large number of sittings, the patients found themselves in the same condition as at the beginning. In other cases the result can only be relative and limited to the alleviation of occasional symptoms, and then pneumatic treatment will be only of equal value with so many other remedies with which we endeavour to contend against the fatal malady.

*5. Pulmonary Hæmorrhages.*

Condensed air, even when compressed to several atmospheres, will neither promote nor induce pulmonary hæmorrhage.

Workmen, who from a high pressure of three to four atmospheres return too quickly to ordinary air pressure, may in this sudden transition be attacked with pulmonary hæmorrhages. In the far slighter condensation of  $1\frac{2}{3}$  to  $1\frac{3}{7}$  atmosphere in the pneumatic chamber hæmorrhages can only occur in persons predisposed to them, when at the close of the sitting during the period of rarefaction the fall of the manometer occurs too rapidly, and thus there is not a sufficiently gradual transition from condensed to ordinary air. Condensed air as such must, on the contrary, be regarded from every simple mechanical point of view as one of the best hæmostatic remedies. The only condition is that the necessary duration shall be given to the period of rarefaction and that the transition to normal pressure shall be sufficiently gradual.

If we decide upon employing compressed air in such cases, we should in the first place fix a longer period than usual for the transition from constant to normal pressure, as in Simonoff's institution, where 50 to 60 minutes are allotted to it instead of the usual 30 to 40 minutes. Even when hæmorrhages have commenced they generally stop in a short time under the influence of compressed air, often even at the commencement of the sitting, but more frequently after three to four sittings; where, on the other hand, we have to do not with one attack, but a series, Simonoff has found 5 to 25 sittings necessary for their complete arrest. Bertin reports the successful treatment of nine cases of hæmoptysis which were cured on an average after 32 sittings, and two cases of improvement after 26 and 50 sittings, while with one patient the attacks of hæmoptysis had ceased after only a few sittings. Bertin raised the period of rarefaction of air to 45 minutes. Pravaz describes a case of habitual and abundant pulmonary hæmorrhage in a girl 13 years of age, who was cured after  $2\frac{1}{2}$  months' use of condensed air and under the control of a special commission of the Lyons Medical Academy. Storch and Simonoff have also observed similar cases.

As regards antagonising the tendency to pulmonary hæmorrhages, it is of course only practicable in cases in which the hæmorrhage is a symptom of a lung affection which can be cured under the influence of condensed air. Cases of chronic pneumonia, which run their course with acute or subacute lobular inflammations or in which numerous foci of softening have already developed, offer the greatest resistance to hæmostasis, and the tendency to hæmoptysis generally persists in the same way even after a long course of pneumatic treatment. The most favourable result obtainable in such cases is only a diminution of the frequency and amount of the hæmorrhages; but there will be no fear of aggravation, even in these hopeless cases, if the pressure be cautiously conducted.

*Counter-indications.*

The use of compressed air in the pneumatic chamber, as may be inferred from what has gone before, is counter-indicated in the following conditions and complications which may be found associated with the pathological state which is known under the name of phthisis:—

1. In *decomposing processes* in the bronchi and lungs, in which there is danger of absorption of putrid substances, as absorption is considerably increased under the influence of compressed air; in blennorrhœic conditions of the bronchi, in putrid bronchitis, in mycotic processes of the bronchi and the lungs, as well as in processes of decomposition and putrefaction in the bronchiectatic dilatations and cavities;

2. In high, *daily recurring fever*, the day temperature, as mentioned above, exceeding 39° C. and pointing to a rapid advance of the local process;

3. In *very weak, reduced individuals*, in whom also the presence of continued fever, even though the temperature is not very high, would render pneumatic treatment of doubtful expediency;

4. In those cases which have already led to large patches of *softening* and *excavations*, where the pressure on the walls of the cavities would be attended with danger, or in those with weak walls, even the ordinary diminishing pressure might lead to hæmorrhages;



### 5. *In general tuberculosis.*

We cannot fix definitely the duration of the treatment in pulmonary phthisis, as it must depend on the pathological changes in the individual case, the general condition of the patient and his capacity for reaction. As the treatment advances, together with attention to the general health of the patient there should be repeated physical examination of the chest, measurements of the vital capacity and of the inspiratory and expiratory pressure by means of the spirometer and pneumatometer, and the result will determine finally whether the treatment shall be continued or suspended.

Simonoff has endeavoured to fix the duration of the treatment in cases running a favourable course from six weeks to several months, and he has certainly not over-estimated the time. Besides, in our climate to avoid relapses it is necessary that the treatment should be repeated in the case of most patients for at least a fortnight to two months every year. In southern climates, where injurious influences which may induce fresh inflammations and destructive processes in the sensitively vulnerable lung are less felt, secondary treatment is not so necessary, though even in those countries physicians recommend the repetition of pneumatic treatment for some years after recovery, to avert the relapses which they have often observed.

### (e) *Pleuritic Exudations.*

Exudations into the pleural sac, after the cessation of inflammatory symptoms, indicate the employment of compressed air (1) to *inflate the lung* more or less compressed by the exudation, (2) to correct or completely remove the *thoracic deformity* resulting from the malady, and (3) to accelerate the *absorption* of the exudation by the pressure exerted upon it from within and without and by the promotion of the processes of absorption under the influence of compressed air. Lastly, even in cases in which bronchial catarrh has been excited in the compressed parts of the lungs increased pressure will remove it more effectually than any other method.

Non-purulent exudations into the pleural sac yield with extraordinary rapidity to treatment by means of condensed air, the more so the younger the patient and the more recent the

exudation. In purulent exudation absorption proceeds more slowly. A rapid reduction of its amount may generally be observed at the commencement of the treatment ; but soon the absorption diminishes in activity, percussion signs alter less or remain unaltered, or else after gradual cessation of absorption fresh exudation occurs, more especially in cases with diffused exudation and defective nutrition. Cases of circumscribed purulent exudation offer a more favourable prognosis, and according to the cases hitherto published, as Simonoff observes, recovery seems to be generally preceded by discharge into the lungs and coughing up of the purulent exudation. Simonoff is disposed to assume that condensed air at first favours the occurrence of this discharge, and afterwards, by expanding the lung, facilitates the expectoration of the purulent exudation and the recovery of the patient.

Unlike other pulmonary affections, the presence of fever does not in any way counter-indicate pneumatic treatment in pleuritic exudations, as a decrease of fever under the influence of the treatment is observed to accompany the amelioration of the malady. When, however, the absorption of the exudation occurs too rapidly, the fever may sometimes be increased, or may be set up suddenly or gradually in patients hitherto free from fever. However, the setting up of fever or its increase is only of short duration and merely dependent on rapid absorption, so that by retarding the absorption through suspending the treatment for a time or by less frequent sittings it may at once be removed in cases in which the strength of the patient renders even a brief duration or temporary elevation of the fever inadmissible. In the majority of cases, however, neither an excess nor an increase of fever is observed even in very rapid absorption of the exudation, and even in debilitated individuals, if it appears or increases for a short time during the treatment, it will very soon disappear again as the case continues to improve, without any alteration of the treatment.

Thirty-five to forty are stated to be the average number of sittings which are necessary for the cure of non-purulent exudations in the pleural cavities, but it is impossible to determine beforehand the number of sittings which may be required for successful treatment of favourable cases with purulent exudation.

*(f) Organic Diseases of the Heart.*

The question whether the employment of condensed air in the pneumatic chamber is or is not indicated in organic diseases of the heart cannot be decisively answered from the observations hitherto published.

Milliet, Storch, Lippert, Levinstein, G. and J. Lange, relying on their own observations, maintain that the influence of condensed air is favourable in these diseases, while Ch. Pravaz and Devay, also guided by their own experience, regard cardiac affections as a counter-indication to pneumatic treatment. Although v. Vivenot, Sandahl, Storch, Brüniche, and the two Langes are of opinion that condensed air acts favourably not only on the symptoms accompanying heart disease but also on the disease itself in cases of dilatation of the right ventricle resulting from affections of the respiratory organs, and although J. Lange thinks it probable that condensed air may ward off fatty degeneration of the heart by improving the nutrition of the cardiac muscle, these are only theoretic possibilities, the discussion of which may be entirely set aside with advantage, seeing the slight probability of their realisation. Simonoff in his report mentions 47 cases, 15 of insufficiency of the aortic valves, 8 of stenosis of the mitral valve, 3 of simultaneous defects of both valves, 9 of dilatation of the right ventricle, 10 of fatty heart, and 2 of fatty degeneration of its tissue, and states that he has observed recovery or improvement only in a few cases of fatty degeneration of the heart and dilatation of its right ventricle; in all the other cases only an alleviation of the symptoms could be effected. This alleviation was subjective as well as objective. First the dyspnœa and cough were greatly diminished; then the cardiac contractions were retarded and restored to regularity; pulmonary congestion, œdema, and consecutive bronchial catarrh were more or less reduced or altogether removed, and lastly the general health was improved. In individual cases the result was surprisingly rapid and obvious to all eyes; the patient, previously hardly able to move and obliged to spend his nights sitting up sleepless, was able after a few sittings, sometimes even after the first, to sleep lying down and to go about without any serious dyspnœa. Simonoff therefore

formulates the following conclusions deduced from his observations: that the action of compressed air

1. Is favourable in the majority of those cases of organic diseases of the heart in which the absolute force of the cardiac muscles is sufficient for the claims made upon it; on the other hand it aggravates the pathological symptoms, or at least fails to improve them, in all patients whose cardiac muscle is absolutely weak and when there is consequently insufficient compensation.

2. In cases of relative insufficiency of cardiac compensation, when it is dependent on obstructions in the pulmonary circulation, condensed air generally produces a greater or less improvement of the symptoms and re-establishes compensation; but if it is caused by obstructions in the greater circulation condensed air acts differently; sometimes an amelioration, sometimes an aggravation of the symptoms is observable; sometimes there is no effect whatever.

3. He considers recovery possible by means of condensed air, and has observed it in cases of fatty degeneration of the heart and dilatation of the right ventricle, if the latter is not dependent on degeneration of the cardiac muscle itself, but on obstructions in the lesser circulation removable by condensed air.

4. Fatty atrophy of the cardiac muscle, always accompanied with absolute weakness of the muscle, may be regarded in most cases as a counter-indication of pneumatic treatment.

As the average number of sittings which are necessary to obtain an alleviation of the symptoms through the influence of compressed air on organic diseases of the heart 30 to 36 sittings are recommended, minimum 7, maximum 79.

#### (B) UTILISATION OF THE CHEMICO-PHYSIOLOGICAL ACTION.

The chemico-physiological action of condensed air on the human body is utilised therapeutically in two ways especially, first in promoting increased combustion of the fat and the carbo-hydrates, secondly by improving nutrition and sanguification.

The use of increased air pressure in the chamber is therefore indicated—

1. *In Obesity.*

The conditions which induce rapid decrease of fat, as observed by Foley, Pol, and François in workers in the diving-bell, the high pressure of  $3\frac{1}{2}$  to 4 atmospheres, the long duration of 6 to 8 hours of residence in it, and the hard, fatiguing work which these men had to execute, are not reproduced in the action of compressed air in the pneumatic chamber. The pressure reaches only  $1\frac{2}{3}$  to  $1\frac{3}{4}$  atmosphere; the residence in the chamber can only be continued for a few hours, and the expenditure of the patient's strength is almost nil in the quiescent condition enforced in the chamber.

Arrangements therefore must be devised by which the action of condensed air in the pneumatic chamber may be at least somewhat increased, and this is done by prolonging the daily sittings over more than two hours and increasing them to twice a day, as well as by extending the duration of the treatment generally; even a higher degree of condensation of air may be attempted if there are no special counter-indications; and lastly the patient's supply of food must be lessened by limiting his diet and excluding all fat-forming substances from it, so that the food taken falls short of the requirements, which are immediately increased, and the expenditure is in excess of the receipts.

For the first 10 to 12 sittings the result of the pneumatic treatment of these patients is generally imperceptible, and they frequently increase in weight in consequence of increase of appetite. Later on, on an average after 30 sittings, corpulent patients, according to Simonoff, begin to show a decrease, and from that point the reduction of fat advances rapidly. Nevertheless, if the desired object is to be attained, the treatment must be energetically pursued for a long time; 60 to 70 sittings and more may become necessary to excite the absorption and oxidisation of an abnormal accumulation of fat, whereas a somewhat considerable decrease of obesity may in favourable cases be obtained after 30 to 40 sittings.

## 2. *In Anæmia and Chlorosis.*

In a series of diseases in which compressed air was employed it was thought that a decidedly favourable influence had been exerted by it on sanguification, a conclusion supported by *à priori* considerations.

Although the processes here in question, and comprehended under the name oligozytæmia, differ in various ways from one another in their genetic and pathological relations, yet one factor is common to them all, viz. relative deficiency of red blood corpuscles, which forms the starting point of the greater part of the changes observed in them. Therefore not only has chlorosis been regarded as a suitable object for the action of condensed air, but also a great variety of other anæmic conditions, whether the sequelæ of great losses of blood and other fluids, or of severe exhausting illnesses, have been submitted to pneumatic treatment, and favourable results obtained, according to the published reports.

According to v. Vivenot the favourable effects here observed from the influence of condensed air must be referred in the first instance to the enlargement of the respiratory surface, by virtue of which in a given time a larger number of blood corpuscles is exposed to the influence of the increased quantity of oxygen admitted in a condensed state and under stronger pressure. Again, it would be conceivable that the increased quantity of oxygen absorbed in this manner, and the chemical activities and altered nutritive processes thus stimulated, might promote a fresh formation of red blood corpuscles. Besides, by simultaneous improvement of nutrition and promotion of digestion and the general strength, all the other indications are fulfilled which tend to produce a favourable result in the various conditions arising out of the causes of oligozytæmia.

According to Milliet, rapid recovery from chlorosis always occurs under a moderate excess pressure not exceeding 15 to 30 centimetres with an average period of treatment of 20 to 25 days. On the other hand the application of higher pressure, as Pravaz has already observed, leads to a negative result.

### 3. *In Whooping Cough.*

If any favourable result has been obtained in whooping cough by treatment with increased air pressure, it can only be referred, in certain stages, to the removal of hyperæmic and inflammatory conditions by the action of mechanical pressure, since it cannot be expected to exercise any effect whatever on the infective parasitical character of the disease already alluded to (*v. supra*) so long as the etiological factors still influence the pathological processes.

In addition to its mechanical influence the property which compressed air possesses of calming the nervous system generally has been thought to act beneficially in the existing hyperæsthesia of the larynx and especially on the superior laryngeal nerve. Lastly, the increase in volume of the lungs and the improved supply of oxygen might be of considerable use in directly antagonising the suffocating paroxysms of cough and the asphyxia to which they give rise.

According to existing observations 2 to 3 weeks with daily sittings of two hours should suffice to cure the malady.

### FURTHER APPLICABILITY OF CONDENSED AIR IN THE PNEUMATIC CHAMBER.

Since compressed air in the pneumatic chamber is to be regarded not only as a remedy acting directly on morbid changes of the respiratory organs and on pathological processes standing in close connection with them, but also, when employed in the form of baths, as possessing general therapeutic properties due to its chemico-physiological action, it has been tried in curative establishments in an extraordinarily large number of maladies of the most various character, and more or less favourable results are reported.

It would lead us far beyond the limits of our subject to speak of these maladies in detail, and it may be left altogether to the physician to judge in each individual case whether the employment of condensed air is indicated or not, according to its mechanical and chemico-physiological action on the body and its functions, already fully described.

No doubt we possess, in the case of most of those diseases already mentioned, partly internal, partly surgical, in which baths of compressed air have yielded favourable results, a number of other methods and means of dealing with them, by which they certainly may be benefited and cured more easily and conveniently than by sittings in the pneumatic chamber. If we were to apply this treatment to all the pathological processes in which a favourable influence may be obtained one way or the other by the mechanical action of raised air pressure on the surface of the body and the lungs, as well as by the respiration of condensed air highly charged with oxygen, the greater part of diseases generally would no doubt be submitted to it.

### B. RAREFIED AIR.

#### EMPLOYMENT OF RAREFIED AIR IN GENERAL.

Air rarefied below the normal atmospheric pressure has not hitherto been employed for therapeutic purposes in the pneumatic chamber, or only exceptionally, as in the experiment recently undertaken by Neumann, although the idea of employing rarefied air in diseases of the respiratory organs and in general morbid conditions is by no means a new one.

Henshaw caused rarefied air to be inspired in his domicilium, and Tabarié and Junod later on made experiments with it in the pneumatic chamber, but theoretical considerations, as well as practical experience of its value, have induced them to abstain from further experiments. Moreover elevated health-resorts with low air pressure give ample opportunity for causing rarefied air to act on the body, and that not only for one or two hours, as in the pneumatic chamber, but during a residence which may be prolonged at pleasure. There are also other favourable influences at work in these places, pure air free from dust, its mobility and the dryness dependent on it, with a series of other factors acting favourably on the nutrition, sanguification, general increase of strength, and on the cerebral function, on account of which residence at these health-resorts must always be preferable to the use of diminished air pressure in the pneumatic chamber.

Thus in discussing the action of rarefied air we have really



reached the limits of our task, and must refer for special information on the value of high altitudes, their properties and indications, to climatic therapeutics.

The mechanical effects produced by the differences of pressure in the transition from ordinary atmospheric pressure to a negative pressure are of interest to us, though in their therapeutic effect they are in no wise at variance with the differences and their equalisation in increasing and decreasing pressure in condensed air, and therefore cause the employment of rarefied air in the pneumatic chamber to appear superfluous in this direction.

The attempt has, however, been made to utilise the action of rarefied air in the pneumatic chamber in yet another way, by either simply alternating the atmospheric and the raised pressure or bringing a lower pressure into combination with it, in order through the difference to obtain a stronger influence on the diminished elasticity of the lung tissue and on expiratory insufficiency than is obtained by compressed air alone and the difference during increasing pressure.

#### EXPIRATION FROM A DENSE INTO A RARER AIR.

G. Lange at Ems and Josephson at Hamburg were the first to introduce into their pneumatic chamber contrivances by which expiration into the atmospheric air is made possible, and therefore the normal atmospheric pressure in expiration, i.e. the action of an equally great minus pressure, is opposed to the excess pressure of  $\frac{2}{3}$  to  $\frac{3}{7}$  atmosphere in the chamber in inspiration. For this purpose the iron wall of the pneumatic chamber is perforated at some place corresponding to the sitting position of the patient, and an indiarubber tube introduced, which enables the patient by means of a mouthpiece or of a mask covering mouth and nose to expire into atmospheric air. In addition to this Pircher connected the pneumatic chamber at Meran with a self-regulating box gasometer for expiration, in which the air is rarefied by the steam engine and this rarefaction regulated according to the desired negative pressure. By expirations into this gasometer the negative pressure of a more rarefied air can be opposed to the increased pressure

of the compressed air in the apparatus, and the mechanical action can be strengthened, as desired, by raising the difference of pressure between the inspiratory and expiratory air. At Reichenhall also and other places such arrangements have now been made for expiration out of the pneumatic chamber into atmospheric or into rarefied air.

There is no doubt that by this combination the influence of the pneumatic chamber on respiration and circulation is very considerably altered, and a force introduced which must act even more energetically on the relaxed elasticity and respiratory insufficiency of the lungs than is attainable by means of the respiratory apparatus.

Whereas by the gradually increasing and decreasing pressure the lung tissue only gradually expands and retracts, here the transition is sudden and immediate. The lungs, which not only undergo a mechanical expansion under the influence of compressed air, but also absorb a larger quantity of air, become suddenly more or less emptied, and whereas previously an excess pressure of  $\frac{2}{5}$  to  $\frac{3}{7}$  atmosphere weighed on the pulmonary surface and its capillaries, it sinks the next moment to a considerable minus pressure, and the forcing of blood from the respiratory surface is followed by its sudden superabundance, which immediately alternates again with the former condition. Even though the retraction of the lung tissue and expiration are materially promoted during decreasing pressure, yet they remain confined within certain limits dependent on the tension of the pulmonary air. As the tension of the air in the lungs only slowly decreases from a higher to a lower pressure, and never sinks below the normal, the elasticity of the lungs will always meet with a resistance which is greater than can be overcome at the moment, and the excursions of their expansion and retraction will be less wide and never extend beyond the normal boundary line; the removal of the residual air in the chamber will also occur only incompletely and in the way of diffusion.

If, on the other hand, the patient under increased pressure expires into rarefied air, not only will the larger quantity of air which through its condensation has been received into the lungs be again evacuated, but by the suction influence of the

rarefied air a portion of that air which the patient himself can no longer expire, and which remains behind as residual air in the air cells, will also be removed. At the same time also a part of that resistance which is offered to the active and passive retraction of the lung tissue in mechanical treatment is removed, the lung becomes capable of contracting to a far smaller volume, and its excursions in inspiration and expiration are extended in both directions beyond the normal boundary mentioned, so that the stimulation of the elasticity of the lungs becomes far greater than can be obtained by the employment of compressed air in the chamber, or even by expiration into rarefied air by means of the transportable apparatus.

However rationally the combination of expiration into normal or rarefied air with the action of increased air pressure on the one hand, and the complete utilisation of the advantages offered by the pneumatic chamber on the other, seem to be justified, yet the method has been exposed to various adverse criticisms, which have not yet been met by a complete experimental refutation.

Certainly Waldenburg's fear that the mechanical influence of expirations into atmospheric air might be so severe upon lungs under the excess pressure of  $\frac{2}{3}$  to  $\frac{3}{4}$  atmosphere that it could not be borne without danger, has been set aside by Josephson and Pircher, whose patients have actually carried out these expirations. Yet Knauthe, by experiments made on himself in the Meran chamber with an excess pressure of  $\frac{2}{10}$  to  $\frac{5}{10}$  atmosphere, has come to the conclusion that expiration into atmospheric air from the chamber in which the air is condensed by 0.2 to 0.5 atmosphere is not deep and full enough, and that the vital capacity does not undergo any important increase by these expirations. Knauthe is of opinion that the obstacle lies in the larynx, which, as Störk previously suspected in inspirations of too highly compressed air, offers a protection against the dangers of deep expirations into too highly rarefied air. Knauthe found that the expiration may indeed be very well performed out of the chamber, but that suddenly a moment occurs in which the glottis closes and cuts off deeper expirations. If nevertheless an attempt be made to force the expirations further, there will be observed, in consequence of the difference

of pressure between the condensed pulmonary air and the rarer air outside the apparatus after the contraction of the glottis, a strong concussion of the vocal cords as the result of the overcoming of the closure of the glottis by the violent efforts at equalisation of the air of different densities. Through these concussions of the vocal cords Knauth was rather hoarse at the close of the sitting, and had for several hours a feeling of soreness in the larynx.

There is, however, another cause of anxiety in the application of too great differences of pressure between compressed and rarefied air, viz. that of inducing by the friction of the air streaming powerfully in and out in the respiratory organs, and also by the repeated changes in pressure and fulness of the capillaries, which, compressed and anæmic during the inspiration of air standing under a high pressure in the chamber, become overcharged with blood by aspiration during the following expirations into normal or else rarefied air, a condition of irritation in the tissues which may lead to inflammatory affections and impede or frustrate the results of the whole proceeding.

Caution will therefore always be needed, if we wish to introduce another factor in addition to the action of compressed air on the retraction of the lung tissue and the increase of vital capacity, not to paralyse the therapeutic effect by too high an increase of the differences between positive and negative pressure. The effect obtained by this combination would then be analogous to the action of the alternating method in the transportable apparatus, in which, however, such amounts of pressure are never employed. It has not, however, yet been ascertained that this procedure has any particular advantage over that of simple expiration into rarefied air.

Pircher made use of expirations from the pneumatic chamber into ordinary and rarefied air with a favourable result in many cases of emphysema and asthma; similar communications have also been made from other quarters as to their utility in these conditions.

## RAREFIED AIR IN THE PNEUMATIC CHAMBER.

MECHANICAL AND CHEMICO-PHYSIOLOGICAL ACTION OF  
RAREFIED AIR.

In general we may safely assume theoretically that the mechanical influences of positive and negative air pressure on the organism will be in contrast to one another, and even when we come to discuss specially the influence on the chemistry of the animal body we shall have to set forth analogous contrasts.

We possess on the whole few experimental investigations as to the influence of rarefied air on the organism, and our information is filled up to a great extent by observations which have been made in quite another manner on the changes in the physiological functions during residence on mountains, climbing considerable heights, and by aeronauts during their aerial voyages. It is evident that there must be differences between these observations and experimental investigations, as in the latter the effects of decreasing and again increasing pressure are combined with those resulting from equalisation, while in the former the phenomena connected with alteration of temperature must be taken into account—purity, mobility, and dryness of the air, its amount of ozone, the varying amount of sunlight, and electric tensions.

*(a) On Respiration.*

Experimental investigations with rarefied air in the chamber have been made by Jourdanet and Legallois, then by v. Vivenot, Lange, P. Bert, and Waldenburg, and have on the whole yielded concordant results.

V. Vivenot's experiments were carried out with a rarefaction of  $-\frac{3}{7}$  atmosphere pressure, which is equivalent to an elevation of about 14,000 feet above the level of the sea (Mont Blanc). The influence of the gradual diminution of pressure at first produced superficial and more frequent respirations, which, however, soon gave place to a full and deep respiration. The inspirations were attended with a great expenditure of strength, while expiration occurred more easily, and the want of air asserted itself automatically by deeper forced respirations. At

the same time the vital capacity diminished in two persons from 3,942 and 4,237 cubic centimetres to 3,448 and 3,843 cubic centimetres, i.e. sank, according to v. Vivenot's observations, by 494 and 394 cubic centimetres, or 12.2 and 9.2 per cent., while P. Bert obtained a reduction of 30 per cent. This decrease of vital capacity is accounted for by the expansion of the intestinal gases under diminished air pressure, by which the diaphragm is elevated and the pulmonary surface thereby decreased.

With these changes in the mechanism of respiration deviations in the excretion of carbonic acid and absorption of oxygen will be observed. G. v. Liebig previously expressed the conjecture, with reference to the results of his experiments with increased air pressure, that in rarefied air the excretion of carbonic acid may undergo an increase, the absorption of oxygen, on the other hand, be diminished and tissue change stimulated. This hypothesis seems to receive confirmation from the more recent observations of W. Marcet. Marcet has made his experiments at various heights and in different climates, on the Lake of Geneva, in the Swiss Alps, on the Island and Peak of Teneriffe, and at the various stations of observation—at which, however, he made a very short stay—and he found the excretion of carbonic acid increased under diminished air pressure. According to the experiments of Jourdanet and Coindet, on the other hand, in Mexico, where the barometric pressure is diminished by more than  $\frac{1}{4}$ , the quantity of carbonic acid contained in the expiratory air amounts to 4.52 per cent. by volume as compared with that at the sea-level. As, however, the volume weight decreases when the pressure is reduced by  $\frac{1}{4}$  atmosphere, and at the same time the volume of air expired in a given time was diminished, therefore they conclude that under a rarefaction of  $\frac{1}{4}$  atmosphere a decrease of excretion of carbonic acid, and thereby also a lowering of the oxidation in the body, had taken place. Legallois found in experiments on animals that under a higher degree of rarefaction of air =  $\frac{2}{3}$  atmosphere the excretion of carbonic acid shows a more considerable decrease.

As regards the absorption of oxygen, P. Bert's experiments show that the average amount of oxygen in the blood decreases rapidly under diminished air pressure, and whereas under

ordinary atmospheric pressure the arterial blood contains 20 per cent. by volume of oxygen, with  $\frac{3}{4}$  atmosphere it absorbs only 18 per cent., with  $\frac{1}{2}$  atmosphere only 13 per cent., with  $\frac{1}{4}$  atmosphere only 7 per cent.

In 9 experiments in which dogs were submitted to the action of a pressure of 460, 440, and 360 millimetres Hg. for the space of about  $\frac{1}{4}$  to  $\frac{1}{2}$  hour, the percentage of oxygen and carbonic acid in the blood was as follows in proportion to the amount under normal atmospheric pressure: <sup>1</sup>—

Number of the Experiment	100 Cubic Centimetres of Blood under Normal Pressure contain		Air Pressure in Millimetres Hg	100 Cubic Centimetres of Blood under Diminished Air Pressure contain	
	Oxygen	Carbonic Acid		Oxygen	Carbonic Acid
5	21.5	34.9	460	20.3	30.5
6	20.1	41.1	460	13.2	40.7
7	17.4	33.8	460	12.5	26.4
8	19.8	29.1	440	16.3	23.3
9	20.6	39.0	360	11.9	25.2
10	20.1	41.1	360	8.9	34.3
11	13.3	34.9	360	8.5	21.4
12	17.4	33.8	360	10.8	22.8
13	16.9	45.7	360	9.6	33.9

The blood withdrawn from one of the animals' arteries during their confinement in rarefied air was of a very dark colour, even, under the highest degrees of rarefaction, exceeding that of venous blood. When the animal, after having been submitted to the influence of lowered air pressure, was brought back into the ordinary atmosphere, the normal relations of gas in the blood were at once restored.

The diminution of the carbonic acid contained in the blood is partly explained in these investigations by the fact that during residence in rarefied air the respiration is accelerated and the individual respirations become deeper, the result of which must be an energetic ventilation of the lungs with a lowering of tension of the carbonic acid in the alveolar air and also an increased giving off of this gas from the blood. But also the formation of the carbonic acid itself and the oxidising processes in the body generally suffer an important reduction by the diminished absorption of oxygen, as the result of the

<sup>1</sup> P. Bert, *La Pression Barométrique*, p. 643, tableau x.

considerably lowered partial pressure of this gas. P. Bert has also endeavoured to furnish experimental proof of the reduction of the processes of combustion by the lowering of air pressure. In experiments on rats of the same litter and weight, which he placed in closed bells, and kept there for various lengths of time under different degrees of air pressure, he obtained the following amounts for the hourly absorption of oxygen and excretion of carbonic acid in these animals<sup>1</sup>:—

	Oxygen Absorbed	Carbonic Acid Excreted
A. Under normal pressure	228 cubic centimetre:	237 cubic centimetres
B. " " "	282 "	246 "
C. " 500 millimetres Hg	246 "	237 "
D. " 370 " "	227 "	180 "
E. " 340 " "	221 "	175 "
F. " 200 " "	160 "	138 "

We must look for the cause of the diminished absorption of oxygen by the lungs during decreasing partial pressure of this gas to diminished rapidity of the diffusion of gases through the walls of the capillaries due to the lower pressure, as well as to a diminution of the pulmonary surface by the elevation of the diaphragm as a result of the distension of the gases enclosed in the intestines, and to the concomitant acceleration of the circulation of the blood. These obstacles to the absorption of oxygen connected with lower air pressure may be compensated to a certain degree if the several respirations gain in depth by the increased activity of the respiratory muscles and enlarge the surface for diffusion in the lungs.

These experimental results are in harmony with the observations of Saussure, Humboldt, Glaisher, the two Schlagintweits, and others, who have observed in climbing to considerable heights above the sea-level a feeling of dyspnoea during exertion and a cyanotic appearance of the mucous membranes and of the skin.

#### (b) *On the Circulation.*

The influence of rarefied air on respiration has for its immediate result on the lungs and the organs of the thoracic cavity, on the skin and the mucous membranes, so far as they are exposed

<sup>1</sup> L.c. p. 725.



to the direct influence of diminished air pressure, an increased fulness of their bloodvessels and an increase of their secretion. In the organs and parts of the body which are withdrawn from its direct influence the quantity of blood becomes less in proportion to the hyperæmia of the surface of the body, and their secretory and excretory activity is reduced.

It appears further from v. Vivenot's investigations that there is an increase of pulse frequency of 13·3 beats to the minute on an average, and an augmentation of the pulse wave; Biot and Gay-Lussac also in their aërostatic voyages, Saussure in ascending Mont Blanc, Jourdanet, Coindet, and P. Bert in their experiments, have more or less dwelt upon the marked pulse frequency, and Glaisher and Lorday have also observed a strengthening of cardiac contractions.

Waldenburg found in his experiments in the pneumatic chamber of the Jewish Hospital at Berlin that the fulness of the radial artery increased under the diminution of air pressure. Analogous to the behaviour of the radial artery, which is undeniable, is that of the other superficial vessels of the external skin, and also especially of the lungs, in which the peripheral capillaries, whose walls offer least resistance to negative pressure, are most surcharged with blood.

The size of the pulse increased with the decrease of air pressure. This behaviour of the pulse presupposes a greater distension of the heart with blood, which is again dependent on the large supply of blood to the lungs.

As v. Vivenot and others had already shown, the circulation was accelerated under diminished air pressure. But apart from the pulse frequency an acceleration of the circulation of the blood was also proved, quite independently of this, and very evidently from the experiments before us. Under normal air pressure the circulatory quotient amounted to 41·7, under lowered air pressure to only 27, but whereas in the first case 41·7 cardiac contractions were necessary for the complete arterialisation of the whole mass of blood this was obtained under diminished air pressure by 27 cardiac contractions. However, by adding hereto the pulse frequency, the acceleration of the blood circulation is considerably increased, and the small proportion of oxygen in the rarefied air, if it does not sink too low, is thus entirely compensated.

Arterial tension increased under diminished air pressure, the collective arterial tension rising from 269 to 422 grammes, the tension of the walls, including resistances, from 124 to 261 grammes. We must suppose the arterial tension to be dependent first on the increase of cardiac force or of relatively increased cardiac efficiency, and secondly on the increase of the peripheral resistances in the circulatory apparatus caused by the greater fulness of the capillaries exposed to negative pressure.

Absolute blood pressure is lowered under diminished air pressure, relative blood pressure, on the contrary, raised. Absolute blood pressure sank from 264 millimetres Hg to 222 millimetres, but this fall of the blood pressure was not proportional to the fall of the air pressure, the latter sinking lower than the former, so that the blood pressure seemed to be rather raised in proportion to the air pressure. The rise of relative with decrease of absolute blood pressure leads us to conclude an increase of cardiac efficiency notwithstanding that its labour is lessened, i.e. a simultaneous lightening of the heart's work notwithstanding that its contractions have become more frequent.

The results of these investigations into the mechanical influence of diminished air pressure on the circulation bring to light an important factor in the beneficial effect of residence in elevated regions, in rarefied air generally, and especially in mountain climates, and we must take it chiefly into account in the therapeutical results published with regard to phthical cases in mountain health-resorts.

With increased afflux of blood towards the surface of the body is associated a feeling of elevated bodily heat, redness of the conjunctiva, and sensation of burning in the eyes. On the other hand long-continued influence of diminished air pressure appears to be attended with lowering of the temperature.

Direct measurements were made by Schyrmunski of the peripheral and central body heat in rarefied air. The peripheral temperature, taken in the closed hollow of the hand, rose during decreasing air pressure and even for some time after the pressure was maintained at constant height, sinking again slowly to something below the original amount. The increase amounted to 1° C. and something over. In the

axilla, at the beginning of rarefaction of the air, the thermometer sank a few tenths of a degree, and rose again, as the pressure again increased, to its former height. The central bodily heat, taken in the rectum, showed in two experiments a rapid decrease up to  $1.2^{\circ}$  C., and rose again as the density of the air again increased with rising pressure. Schyrmunski refers the phenomena to the more abundant afflux of blood to the periphery in a rarefied atmosphere (v.s. Stembo's estimates of temperature under increased air pressure).

Bert has in an experiment lowered the body temperature of a healthy dog by  $2^{\circ}$  C. by rarefaction of air up to 250 millimetres, answering to  $\frac{1}{3}$  atmosphere pressure, and Lorday observed, in ascending Mont Blanc, a fall of body heat, which Jourdanet, in answer to Forel's objections, attributes to the permanent influence of decreased air pressure and to fully developed *mal de montagne*. Reissacher reports that in the gold mines at Gastein, in Rauris, at a height of 7,300 feet, corresponding to a rarefaction of something above  $\frac{1}{4}$  atmosphere, only very strong men are able to work, and even these become incapable of labour at 40 years of age, on account of increasing difficulty of breathing and weakness in the legs. Jourdanet assumes as the cause of this functional alteration a change in the blood, which he designates anoxyhæmia, and which, he says, differs from ordinary anæmia in this, that its injurious action on the body is not dependent on decrease of the number of red blood corpuscles, but on their being insufficiently saturated with atmospheric oxygen. As the amount of hæmoglobine in the venous blood and the rapidity of circulation increases with the muscular activity, it is evident that in muscular work the blood becomes less saturated with oxygen under low than under high oxygen pressure. The great exhaustion arising from moderate exertion in rarefied air, in climbing high mountains, is undoubtedly dependent on this, and under very low oxygen pressure a muscular movement may be fatal, while there is no danger in a state of rest. Sivel and Croce-Spinelli probably lost their lives in this way in their last voyage. The cause, according to Hoppe-Seyler, must be the insufficient rapidity of diffusion in the lung, on account of the low oxygen pressure of the atmospheric air.

*(c) On Change of Tissue.*

Owing to the influence which the reduction of the partial pressure of oxygen and the diminished rapidity of its diffusion in rarefied air exercises on the amount of oxygen and the arterialisation of the blood, the question of tissue change in the organism and the excretion of nitrogen in the urine gains increased interest. P. Bert<sup>1</sup> indeed found in 5 out of 7 experiments that the excretion of urea suffered a considerable diminution even up to 50 per cent. during residence in rarefied air; but, as his experiments were not undertaken in a determined condition of equilibrium of the animals, the figures given by him, like those from the experiments on the influence of compressed air in the excretion of urea, cannot be regarded as the expression of altered tissue changes.

A. Fränkel has shown that a continuous intense reduction of the absorption of oxygen has for its result an abnormal disintegration of the tissues of the living organism. The experiments from which this fact was deduced were carried out in the following manner: In dogs whose excretion of nitrogen had become constant by appropriate experimental conditions the absorption of oxygen was suddenly and for a long time reduced to a minimum by the introduction of a respiratory obstruction into the trachea. The objections raised by Eichhorst have not as yet been able to disprove the accuracy of the results of the experiments or to weaken the force of their evidence, but the numerical estimation of the excretion of urea in children suffering from laryngeal croup in whom, in the stage of the severest dyspnoea as well as later on after the respiratory obstacle had been removed by tracheotomy, he estimated the amount of urea in the urine, testifies rather in favour of the observations first made by A. Fränkel. A. Fränkel has also in two series of experiments, by arresting the afflux of oxygenised blood by means of plugging the aorta abdominalis and interrupting the whole circulation of the lower part of the body, obtained a distinct increase in the excretion of urea, though not so considerable as in the experiments with the artificially introduced respiratory obstruction.

<sup>1</sup> L.c. pp. 728 and 729.

The case is different, however, with regard to air in the pneumatic chambers and in elevated health-resorts, in which no such considerable decrease of oxygen comes into play as in those experiments or in the insufficient respiration of croupy children.

A. Fränkel has performed a series of experiments in this direction in the pneumatic chamber at Berlin, by causing a dog whose absorption and excretion of nitrogen were equilibrated to remain 5 hours in air rarefied by half an atmosphere, the first 30 minutes of the confinement being spent in gradually reaching the minimum pressure, the last 15 to 20 in restoring the normal atmospheric pressure. The animal was thus exposed to the full action of diminished air pressure each time  $4\frac{1}{4}$  hours. In the following page we give a tabulation of the estimates necessary for the right comprehension of the experiment.

After the total excretion of nitrogen by the animal had been brought on an average to 22·55 grammes it excreted in the next three days, while breathing air the pressure of which was lowered half an atmosphere, 24·04, 24·66, and 24·53 grammes of nitrogen in the urine and fæces. Unfortunately the experiments were interrupted for a day by Sunday's intervening, and in consequence of an accident which occurred during the collection of the urine on the 10th of November this day also must be excluded from the calculation. In the last five days spent in rarefied air, on the other hand, a distinct influence on the excretion of nitrogen is no longer recognisable, although its average (22·85 N.) still exceeds that of the normal days and of the previous experiments under raised pressure (v.s.)

With regard to the explanation of the increased excretion of nitrogen observed under the influence of lowered pressure, A. Fränkel sees in it a confirmation, though not a very pregnant one, of his previous experiments on the action of diminished supply of oxygen on the disintegration of albumen. He considers himself all the more justified in drawing this conclusion because, according to P. Bert's communications, in the lowering of atmospheric pressure to the degree of rarefaction which he employs, the quantity of oxygen contained in the blood becomes less than normal and the oxidating pro-

Date	Body Weight	Absorptions		Excretions			Total Amount of Nitrogen in Urine and Faeces	Temperature	Remarks
		Meat and Bacon	Water, Drunk	Quantity of Urine	Specific Weight of Urine	Faeces			
Nov. 2	31,850		175	408	1057.5	0	21.20	Mg. Evg. 38.0	Initial experiments.  5 hours in rarefied air. Total nitrogen in urine by combustion in the tube = 23.54. 5 hours in rarefied air. 5 hours in rarefied air. No rarefied air inspired. 5 hours in rarefied air. In collecting the urine loss of at least 25 cubic centimetres. 5 hours in rarefied air. 5 " " " " 5 " " " " 5 " " " " 5 " " " "
3	31,700		480	444	1053.0	0	22.32	38.3	
4	31,850		300	438	1054.5	0	21.76	38.1	
5	31,850		176	432	1055.0	0	21.84	38.2	
6	31,750		280	480	1053.0	0	23.52	38.1	
7	31,550		225	500	1053.0	0	24.14	38.2	
8	31,300		550	494	1052.0	0	24.01	38.5	
9	31,400		470	474	1051.0	220	22.64	38.2	
10	31,300		150	460?	1053.5	0	21.36?	38.2	
11	31,050		200	444	1055.0	0	22.16	38.0	
12	30,800		380	472	1051.0	0	22.40	38.4	
13	30,850		400	484	1052.0	0	22.60	38.3	
14	30,850		470	478	1050.0	0	21.76	38.2	
15	30,900		300	466	1053.0	0	22.72	38.1	
16	30,850		480	484	1048.5	95	21.84	38.1	
17	30,950		350	490	1049.5	0	21.84	38.2	
18	31,000		340	460	1051.5	0	22.48	38.2	
19	31,000		250	422	1055.0	103	21.04	38.1	
			Daily 700						

cesses, absorption of oxygen through the lungs and giving off of carbonic acid, undergo a decrease. He is disposed to regard the decrease of the action of diminished pressure on the excretion of nitrogen during the last five days of the experiment as due to the animals becoming gradually accustomed to the influence of rarefied air. Since, according to experience, the functional disturbances connected with residence in highly rarefied air become gradually compensated during prolonged continuance in it, therefore it is highly probable that, in consequence of increasing activity of the respiratory muscles and the greater expansion of the lungs thereby induced, the exchange of gases also returns gradually to the normal.

The last thing to be noted is the considerable decrease of body weight in the animal, amounting to nearly 1 kilogramme, = 3 per cent., during the time spent in rarefied air. Fränkel and other authors are of opinion that this is very probably exclusively occasioned by the increased excretion of water by the skin and lungs.

(d) *On the Brain, the Spinal Cord, and the General Condition.*

In addition to the changes in the respiratory and circulatory organs a series of symptoms were observed in v. Vivenot's experiments which must be referred to hyperæmia of the surface of the body and a consequent anæmia of the central organs, inducing conditions sometimes of excitement, sometimes of depression in the peripheral nervous apparatus and in the brain and spinal cord. Neuralgic pains were set up in the teeth, neck, and forehead, while confusion in the head, vertigo, and difficulty of thinking were observable. These symptoms were followed later on by general bodily weakness, nausea, and tendency to vomit. When the air pressure was reduced to 450 millimetres, =  $\frac{3}{8}$  atmosphere pressure, P. Bert perceived in his apparatus that the symptoms of *mal de montagne* gradually developed and increased in proportion to the diminution of the air pressure. The symptoms specially noticeable were heaviness and bodily weakness, nausea, fatigue of the eyes, general indifference, unconquerable laziness and disinclination to mental activity. When the air was rarefied to  $\frac{3}{7}$  to  $\frac{1}{2}$  atmosphere he was no longer capable of multiplying the number of his pulse beats by three; later on

an uncontrollable spasmodic trembling came on when he lifted up his right leg, which communicated itself to the left leg and lasted several minutes. His face was by this time congested, the temperature under the tongue elevated by the peripheral hyperæmia by 0.1 to 0.2 per cent. C. The vital capacity estimated by the spirometer showed a decrease in the ratio of 17 : 12; under a pressure of less than 450 millimetres he could no longer whistle. It also appears to be deducible from P. Bert's experiments that some of these symptoms are materially dependent on diminution of *oxygen pressure*, for by inspiring pure oxygen gas he was able to moderate the pulse frequency and at the same time to get rid of the indisposition, while the pressure of the surrounding air was far below 400 millimetres. The two aëronauts Sivel and Croce-Spinelli, who used Bert's apparatus in preparing for their aërial voyages, also observed analogous symptoms in themselves. Up to 370 millimetres mercury they felt well and conversed freely; with 307 millimetres they became silent, very tired, one more strongly affected than the other; when the rarefaction of air had sunk to 300 millimetres (approximately equal to  $\frac{2}{3}$  atmosphere pressure) Sivel's lips turned blue, his right ear became almost black, his health failed, and he lost his sight for a time. Here again inspirations of pure oxygen gas dispersed the symptoms for a time.

The decrease of muscular strength in work and movement is a constant effect of lowered pressure, and is mentioned unanimously by Saussure, Humboldt, Jourdanet, Schlagintweit, Weber, Coindet, P. Bert, and others.

According to P. Bert's experiments in the pneumatic apparatus, and from the observations of Sivel, Croce-Spinelli, and Tissandier during their balloon voyages, the following effects are produced on the animal organism under progressive rarefaction of air:—

(a) A general depression of the atmospheric air pressure to 264 or even to 248 millimetres, answering to an oxygen tension of 49.6 or 7.28 to 6.84 per cent. of an atmosphere, may be borne for a short time by human beings, mammalia, and birds; nevertheless in this lowering of oxygen tension death may also supervene under certain conditions not yet determined (Sivel and Croce-Spinelli).



(b) With a reduction of atmospheric pressure to 280 millimetres, corresponding to about 8,000 metres above sea-level, great weariness set in immediately, rising to unconsciousness (Tissandier and Bert's experiments on animals); but by inspiration of oxygen the effect of this rarefaction of air may be partly neutralised and therefore tolerated.

(c) P. Bert rarefied highly oxygenised air to 135 and even 95 millimetres mercury pressure for a very short time, and kept a sparrow still alive in these tensions. When in another experiment with atmospheric air he had lowered the pressure to 220 millimetres, and the condition of the bird became worse and worse, he admitted pure nitrogen gas into the bell to equalise the pressure with the external atmosphere; however the bird succumbed in a short time.

It is thus ascertained by facts that life is possible under reduction of atmospheric pressure only within certain limits of oxygen tension; if the latter is reduced too low increase of respiratory and pulse frequency and decrease of body temperature, exhaustion, and unconsciousness occur; death itself inevitably supervenes under an oxygen tension of 3.5 to 3 per cent. of an atmosphere.

#### INDICATIONS FOR THE EMPLOYMENT OF RAREFIED AIR.

From these mechanical and physiological effects of rarefied air we may deduce the several indications under which it should be employed therapeutically in various diseases of the respiratory organs and in other pathological processes.

We are not in possession of any continuous observations worth mentioning on the curative action of rarefied air as such and the application of the different degrees of pressure in the manifold circumstances in which it might be indicated.

If we place in order the groups of symptoms in which various degrees of reduction of air pressure might exercise a favourable influence, we must range in the first place those cases in which it appears necessary to promote an increased afflux of blood to the lungs and respiratory organs generally, as in many cases of pulmonary phthisis; then in the next place to the external skin, to the pharyngeal, oral, and nasal mucous

membranes, and to those other organs and tissues which are exposed to the direct influence of air pressure. On the other hand diminished air pressure might also be indicated in cases in which it is desirable to diminish the afflux of blood to the vertebral canal, to the liver, the kidneys, the intestine and other glandular organs, whose secretion we desire to lessen ; to the uterus, to the bones, muscles, and those parts of the body which are withdrawn from the immediate influence of lowered air pressure.

It has also been thought that rarefied air as such would act favourably on the expansion of the air cells and the diminished elasticity of the lung tissue in emphysema and promote the contraction of the lungs during expiration. But so soon as pressure, whether positive or negative, acts at the same time on the surface of the body and of the lungs, the mechanism of respiration and the expansion of the lungs is not altered in the manner desired by these changes of pressure alone, but only by the equalisation of pressure, which, however, in rarefied as in condensed air, rapidly passes off during continued residence. Further, the hæmoglobine compounds in the blood under low oxygen pressure only obtain the necessary saturation with oxygen when circulatory rapidity decreases and the surface of diffusion is increased, when the increase in the volume of the lungs is accompanied with the same changes in the form of the thorax as in such high-lying regions as Mexico, Thibet, and some parts of India. Frequently the thorax of mountaineers or of persons who have spent a long time on mountains increases in breadth and depth ; the lungs become expanded and emphysematously dilated.

Rarefied air might also be employed, as its inspiration necessitates an increased frequency of respiratory movement, and consequently additional activity of the inspiratory muscles, in those cases of feebly developed muscular action of the chest in which an active gymnastic exercise of the respiratory muscles seems necessary when there is no already existing disease of the respiratory and circulatory organs to be aggravated by the increased afflux of blood or to give rise to the fear of vascular rupture and hæmorrhage.

Lastly, the employment of rarefied air has been considered

to be indicated in certain states of depression as a means of stimulating the nervous system, though certainly the action of elevated climates cannot be identified with that of lowered atmospheric pressure.

The employment of rarefied air, according to its mechanical and physiological effects, is counter-indicated in all cases which can derive benefit from condensed air, as the two stand diametrically opposite to one another not only in their physiological properties but in their therapeutic effects.

By this rule most diseases of the respiratory organs, of the heart, and of the circulation, as well as those cases of disturbances of nutrition and irritation of the nervous system in which increased atmospheric pressure and greater tension of oxygen act beneficially, will be excluded from treatment with rarefied air. Besides it is also to be taken into consideration that even though there should appear to be indications in one sense or another for the use of lowered air pressure, it must be suspended as soon as inanitionary disturbances are to be feared from the weakening influences of rarefied air on the general nutrition.

#### THERAPEUTIC USES OF RAREFIED AIR.

Therapeutic utilisation of rarefied air pressure, such as might be deduced from the existing indications, has been hitherto neglected in the pneumatic chamber, because, as we have already said, residence in elevated regions was considered preferable for obtaining the general effects of rarefied air, and the mechanical effects which result from the equalisation of the differences of pressure in the lowering of air pressure were obtained by increasing and decreasing the pressure of *compressed* air. The effects of lowered air pressure in the chamber are not, however, identical with those which result from residence on heights.

The reduction of air pressure in the chamber to  $-\frac{3}{7}$  atmosphere is far greater than is obtained in mountain health-resorts; hence the mechanical effects which result from the equalisation of increasing and decreasing pressure are also more energetic than those which are observed after the transition from the plain to the heights, and they entirely disappear after the first few days in consequence of the accommodation of the

organism. As residence in the chamber with rarefied air could not last longer than  $1\frac{1}{2}$  to 2 hours, so here also the greatest part of it would be spent under the influence of decreasing and again increasing pressure, and the action of constant diminished pressure, after the equalisation of the differences, would be limited to a short time or even not come into play at all.

Residence in mountain health-resorts, on the contrary, extends over several weeks, and should, therefore, be compared with an equally long sitting in rarefied air; only the constant diminution of pressure will be capable of exercising more or less considerable influence upon the organism and its functions, while the mechanical effects of the equilibration of pressure only occur in the transition time, and cease when the equalisation of pressure in the whole body is established. The elevation of the most frequented mountain health-resorts is usually from 400 to 1,500 metres, and seldom reaches 1,900 or 2,000 metres, so that only a diminution of the normal atmospheric pressure (760 millimetres at the sea-level) of about 50 to 150 millimetres is obtained, equivalent to a diminution of  $\frac{1}{15}$  to  $\frac{1}{5}$  atmosphere pressure. The difference between the air pressure on the plains and that in these mountain health-resorts is not great enough to induce a considerable mechanical change in the organs which are submitted to its influence, or specially to modify their functions, and the organism therefore soon fully accommodates itself to them during a prolonged residence. On the other hand, the favourable effects which have been observed after a long residence in these elevated health-resorts on tissue change in general, on sanguification, nutrition, increase of strength, and active stimulation of the physical and psychical functions of the brain, are partly also dependent on the concomitantly active factors of situation, temperature, the quality of the air, and other co-operating curvative means, baths, mineral springs, and favourable modifications of diet and general mode of living, and the slight reduction of air pressure can meanwhile only exercise a more marked effect on those organs whose blood channel, as above mentioned, suffers changes in size and fulness under its influence.

It has been thought that the diminution of air pressure acts

physico-chemically in another sense, and the immunity of certain elevated places, partly from phthisis and scrofula, partly from infectious diseases the foundation of which is miasma, has been referred to this cause. We here, however, approach the end of our therapeutic labours. The critical examination of these hypothetical assumptions, which, as regards phthisis and scrofula, are already disproved, as well as the discussion of the special mode of action of those elevated health-resorts, belong to another part of general therapeutics, climatology and climato-therapeutics, to which we must here refer.

There is no connection whatever between the physico-chemical properties of rarefied air and its influence on the animal and vegetable organism and those local conditions of immunity, more especially as regards infectious diseases, nor are they dependent on the lowering of oxygen tension resulting from reduced air pressure, which, however, is too slight to exert any influence upon the oxidation processes at work here, and it is unnecessary to consider them at further length in this place.



# I N D E X.

---

## ABD

- A**BDOMINAL respiration, 576
- Absorption, in compressed air, 667; of inhaled substances, 52, 55, 104
- Acetate of lead inhalations, 160; in bronchial catarrh, 161; in bronchorrhœa, 161; in hæmorrhages, 161; in laryngeal catarrh, 161, 299; in pulmonary gangrene, 161; in pulmonary phthisis, 161. V. also Salts of lead inhalations
- Acetic acid inhalations, 88, 115; in coryza, 264
- Acetic ether, inhalations of, 226. V. Ether inhalations
- Acetone inhalations, 226
- Acetum aromaticum, inhalations of, 88
- Adler, 369
- Air pressure, altered, acting locally, application of, 521; altered, in the lungs, exchange of gases in connection with, 505; as applied in the pneumatic chamber, 618; diminution of, on the thoracic surface, 589; rapid increase of, and its results, 681
- Aix-la-Chapelle, inhalations at, 238, 254
- Albers, 12
- Alcoholic intoxication, caustic ammoniated inhalations in, 226; general condition in rarefied air, 725
- Alkaline inhalations, in bronchitis putrida, 196; in laryngeal tuberculosis, 306; in pharyngitis phlegmonosa, 272; in pulmonary phthisis, 344
- Alterative inhalations, 93, 188
- Althæa root, inhalations, of infusion or decoction of, 125; in angina phlegmon, 272; in apex catarrh, 341; in combination with compressed air, 519; in coryza, 263; in laryngeal, tracheal, and bronchial catarrh, 340

## AMM

- Alum inhalations, 155; anaesthesia of pharyngeal and laryngeal mucous membrane by means of, 309; in apex catarrh, 342; in bronchial catarrh, 310, 342, 343; in bronchial hæmorrhages, 261; in bronchiectasis, 156, 316; in bronchitis putrida, 156, 315; in broncho-pneumonic ulcerations, 356, 358; in bronchorrhœa, 156, 314; in desquamative pneumonia, 344; in diphtheria, 156; in emphysema, 323; in hæmorrhages of the respiratory organs, 156, 358; in laryngeal abscess, 290; in laryngeal catarrh, 285, 286, 287, 300; in laryngeal ulcers, 263; in laryngitis, croupous, 296; in laryngitis, parenchymatous, 289; in oral hæmorrhages, 258; in oral syphilis, 284; in ozæna, 156; in paresis of the vocal cords, 308; in pharyngeal hæmorrhages, 258; in pharyngeal syphilis, 284; in pharyngitis, 156; in pulmonary hæmorrhage, 156, 261; in pulmonary phthisis, threatening, 156, 336, 342, 343, 344, 356, 358; in whooping cough, 319; respiratory organs during, 156
- Alumen depuratum, inhalations of, v. Alum inhalations
- Alvine evacuation in compressed air, 663
- Amati, 371
- Amblyopia, amyl nitrite inhalations in, 147
- Amélie-les-Bains, inhalations of the mineral water of, 354
- Ammoniacal inhalations, 93, 181, 226; combined with camphor, 181, 227; in alcoholic intoxication, 226; in angina tonsillaris, 181; in aphonia, 181; in asthma, 182; in catarrhs of

- the respiratory organs, 182; in coma, 226; in coryza, 182, 264; in fainting fits, 226; in hoarseness, 181; in narcotic poisonings, 226
- Ammonium bases, inhalations of, 294; in bronchial croup, 317; in bronchial diphtheria, 317; in laryngeal diphtheria, 294; in laryngitis, 295; in tracheitis, 295
- Ammonium causticum, inhalations of, v. Ammoniacal inhalations
- Amm. hydrochloricum, inhalations of, v. Sal ammoniac inhalations
- Amygdalæ, amaræ, v. Bitter almond water inhalations; dulces, v. Sweet almond oil inhalations
- Amyl nitrite inhalations, 93, 144; in amblyopia, 147; in angina pectoris, 146; in asthma, 146, 326, 519; in Cheyne-Stokes's respiratory phenomenon, 146; in combination with compressed air, 519; in eclampsia, 146; in epilepsy, 146; in hemicrania sympathicotonia, 146; in hysteria, 146; in lead colic, 146; in otalgia, 147; in singing in the ears, 146, 147; in tetanus, 146
- Amylenum nitrosum, inhalations of, v. Amyl nitrite inhalations
- Anemia of the lung, deep inspirations in, 579; oxygen inhalations in pneumatic treatment in, 244
- Anesthesia, by means of chloroform inhalations, 130, 139; ether inhalations, 130, 139; ethyl bromide inhalations, 138; narcotic inhalations, 130; nitrous oxide inhalations, 130, 143; of the laryngeal mucous membrane by inhalations, 309; of the pharyngeal mucous membrane by inhalations, 309
- Anesthesia, local, apparatus for, 67
- Andeer, 218, 220
- Aneurysma aortæ, nitrous oxide inhalations in, 144
- Angina catarrhalis, erythematosa, v. Pharyngeal catarrh
- Angina pectoris, amylnitrite inhalations in, 146; nitrous oxide inhalations in, 144
- Angina phlegmonosa, inhalations in, 272. V. Pharyngitis
- Angina tonsillaris, ammoniacal inhalations in, 181; astringent inhalations in, 151; carbonate of soda inhalations in, 176; cold water inhalations in, 117; sulphur water inhalations in, 236
- Angiometer, v. Pulsuhr
- Animal oil, ethereal, inhalations of, 227
- Aniseed oil as addition to inhalation of infusion of camomile flowers, 88
- Antiputrid inhalations, 188, 189, 204; in bronchiectasis, 196; in bronchitis putrida, 195; in cavities, 196; in laryngeal cancer, 193; in pneumomycosis, 197. Cf. Antiseptic inhalations
- Antipyretic inhalations in pulmonary phthisis, 351
- Antiseptic inhalations, 93, 188, 189, 194, 204; in bronchiectasis, 196, 329; in bronchitis putrida, 195, 312; in bronchorrhœa, 312; in cavities, 196; in diphtheria, 195; in laryngeal cancers, 193; in laryngeal ulcers, 193, 301; in laryngitis, 296; in perichondritis laryngea, 304; in pharyngeal ulcers, 94; in pulmonary gangrene, 193, 196; in pulmonary phthisis, 197, 351; in tracheal cancer, 193; in tracheitis, 296. Cf. Disinfecting inhalations
- Antyllus, 8, 200
- Aortic aneurism, nitrous oxide inhalations in, 144
- Aortic system, in expiration into compressed air, 481; in expiration into rarefied air, 495; in inspiration of compressed air, 461; in inspiration of rarefied air, 488
- Aortic valves, insufficiency and stenosis of, pneumatic treatment in, 570
- Apex catarrh, nitrogen inhalations in, 250; pneumatic treatment of, 341, 560, in the pneumatic chamber, 697; respiratory treatment of, 341. Cf. Lungs, consumption of,
- Aphonia, alum inhalations in, 308; ammoniacal inhalations in, 181; animal oil inhalations in, 227; camphor inhalations in, 227; chloride of iron inhalations in, 157; nerve-exciting inhalations in, 225; oil of turpentine inhalations in, 201, 308; Peruvian balsam in, 308; pine oil inhalations in, 308; sulphate of zinc inhalations in, 162; sulphur water inhalations in, 238; tannin inhalations in, 308; Tolu balsam inhalations in, 308
- Apthous processes in the oral cavity, chlorate of potash inhalations in, 177; hypermanganate of potash inhalations in, 207
- Apnoea, ether inhalations in, 140; nerve-exciting inhalations in, 225; oxygen inhalations in, 244



## APP

Apparatus, for generating vapour, 82; for inhalations, v. Inhalatory apparatus; for inhaling vapour, 82; for local anaesthesia, 67; for pulverising, v. Inhalatory apparatus; for pulverising fluids, v. Fluids; for rarefaction and condensation of air, cf. Pneumatic Apparatus

Aqueous vapour inhalations, 124. respiratory organs with regard to, 57

Aqueous vapour in the air, on the compression of, 636

Archigenes, 83, 198

Arcteus, 7, 19

Argentum nitricum, inhalations of, v. Silver, nitrate of, inhalations

Aristotle, 9

Arnus, 21

Aromatic inhalations in pulmonary phthisis, 343, 354

Arsenic cigars, 233

Arsenic inhalations, 233; in asthma, 233, 234; in emphysema, 234, 323; in laryngeal neurosis, 233; in phthisis, 233

Arteria subclavia, pulse in inspiration of compressed air and expiration into rarefied air with regard to, 468, 487

Arterial tension, in expiration into compressed air, 482; in expiration into rarefied air, 495, 499, 502; in inspiration of compressed air, 476; in inspiration of rarefied air, 488, 490, 492; in Müller's experiment, 490; in the pneumatic apparatus, 657, 659; in rarefied air, 720

Arytænoiditis, astringent inhalations in, 151

Asafœtida, inhalations of, 227

Ascherson, 243

Asphyxia, ether inhalations in, 226; nerve-exciting inhalations in, 225; oxygen inhalations in, 244; pneumatic treatment of, by diminution of the air pressure on the thoracic surface, 601, in the pneumatic chamber, 631, with condensed air, 526

Asthma, ammoniacal inhalations in, 182; amyl nitrite inhalations in, 146, 326, in compressed air, 519; arsenic inhalations in, 233, 234; asafœtida inhalations in, 227; balsamic inhalations in, 204; belladonna inhalations in, 325; cannabis indica inhalations in, 135, 325; carbonate of potassium inhalations in, 327; carbonate of soda inhalations in, 327; carbonic acid inhalations in, 252; castor in-

## BAL

halations in, 227; chloroform inhalations in, 140, 326; cold air inhalations in, 115, 325; cold water inhalations in, 119; *complicated with bronchial catarrh*, pneumatic treatment of, 546, 550; *complicated with emphysema*, pneumatic treatment of, 515; Esjic cigarettes in, 325; ether inhalations in, 140, 326; ethyl iodide inhalations in, 326; fumigations in, 325; hyoscyamus inhalations in, 326; methyl bichloride inhalations in, 326; narcotic inhalations in, 129; nitrate of potassium in, 178, 325; nitrogen inhalations in, 251; nitrous oxide inhalations in, 144; opium inhalations in, 325; oxygen inhalations in, 243; pneumatic treatment of, 327, 528, 546, in the pneumatic chamber, 594, 714; prussic acid inhalations in, 136; sal ammoniac inhalations in, 175, 519; salt, common, inhalations in, 327; stramonium inhalations in, 133, 325; sulphur water inhalations in, 238; sulphuretted hydrogen inhalations in, 254; tobacco inhalations in, 136, 326; water fennel inhalations in, 325

Astringent inhalations, 147; blood-vessels during, 148; disinfection by means of, 149; in angina catarrhalis, 151; in arytænoiditis, 151; in bronchitis, 151, 196, 310; in bronchorrhœa, 311; in catarrhs, 150; in chorditis ventricularis and vocalis, 151; in epiglottitis, 151; in hæmorrhages, 151; in laryngeal catarrh, 151; in laryngeal ulcers, 303; in laryngitis, croupous, 296; in laryngitis, parenchymatous, 289; in meso-arytænoiditis, 151; in pharyngitis, 151; in pulmonary consumption, 343, 344; in tracheal catarrh, 451; in tracheitis, 296; in tonsillitis, 151; secretions in connection with, 148

Atelectasis, congenital, diminution of air pressure on thoracic surface in, 601

Auphan, 14, 20, 55

Aural catarrh, Valsalva's experiment in, 584

Avena, 22

**BADEN**, near Vienna, inhalations of the mineral water there, 238, 254

Bagnères de Luchon, inhalations of the mineral water there, 254

Balard, 145

Balsamic inhalations, 203; disinfection

## BAL

- by means of, 203; expectoration in, 203; in asthma, 204; in bronchial catarrh in compressed air, 532; in bronchiectasis, 316; in bronchitis putrida, 196; in emphysema, 204; in laryngeal ulcers, 203, 302; secretions in, 203
- Balsamum vitæ Hoffmanni, inhalations of, 204
- Bamberger, 324
- Barthez, 155
- Basch, von, 370
- Bataille, 16, 39, 155
- Bauer, 616
- Baumgärtner, 20, 21, 63, 141, 142
- Becker, 517
- Beddoes, 10, 19
- Belladonna inhalations, in asthma, 325; in bronchial catarrh, 343; in emphysema, 323
- Belladonna leaves, saturated with salt-petre, used for smoking, 179
- Bellows, apparatus for pneumatic treatment on the principle of, 410
- Bells, pneumatic, v. Pneumatic chamber
- Bennet, 9, 19, 124
- Benzine inhalations, 208
- Benzoate of soda inhalations, 211; disinfection by means of, 211; in bronchial catarrh, 357; in bronchitis, 212; in bronchorrhœa, 212, 314; in broncho-pneumonic ulcerations, 352, 354, 355, 357; in diphtheria, 211, 277, 280; in infective diseases, 212; in laryngeal abscess, 290; in laryngeal phthisis, 212, 306; in laryngeal ulcers, 301; in perichondritis laryngea, 305; in pneumomycosis, 360; in pulmonary gangrene, 332; in pulmonary phthisis, 212, 352, 354, 355, 357, 360, 362; in whooping cough, 322
- Benzoic acid inhalations, 203, 210; expectoration in, 210; in bronchial catarrh, 210; in bronchiectasis, 210; in bronchitis putrida, 210; in bronchorrhœa, 210; in laryngeal phthisis, 210; in pulmonary gangrene, 210; in pulmonary phthisis, 210; in whooping cough, 322; secretions in these, 210. Cf. Benzoate of soda inhalations
- Benzoic resin, used for inhalations, 210
- Benzol inhalations, 93, 208
- Benzole peroxide, inhalations of, 217
- Bergson, 21, 44, 64, 66, 67, 68, 69, 70, 73, 78, 79, 81, 105, 106, 107, 117, 258, 261, 267, 271, 280, 294, 333

## BOP

- Berkart, 17, 367, 370, 375
- Bernard, 38
- Bernheim, 370
- Bert, 22, 143, 144, 239, 240, 243, 616, 617, 661, 662, 670, 672, 679, 681, 682, 716, 718, 719, 721, 722, 725, 726, 727
- Bertin, 13, 613, 614, 634, 637, 656, 664, 686, 701
- Berton, 12, 229
- Biedert, 17, 18; 146, 329, 368, 375, 410, 437, 439, 440, 441, 444, 503, 504, 505, 515, 519, 530, 531, 532, 548, 549, 554, 570
- Biermer, 21, 183, 184, 312, 316, 317, 322, 324
- Bilin, inhalations of the mineral water of, 236
- Bill, 213
- Billard, 200, 203
- Binz, 223
- Biot, 719
- Birch-Hirschfeld, 22, 216, 243, 319, 322
- Bitter almond water inhalations, 93, 136; combined with inhalations of chloride of iron, 158; in bronchial catarrh, 342; in pharyngeal catarrh, 270; in pulmonary phthisis, 342
- Blake, 144, 145
- Blanc, Le, 214
- Blennorrhœa of the respiratory organs, stimulating alterative inhalations in, 191, sulphur water inhalations in, 254
- Blood pressure, in expiration into rarefied air, 496; inspiration of compressed air in connection with, 461, 463, 467, 477; in inspiration of rarefied air, 491; in the pneumatic chamber, 660; in rarefied air, 720
- Bloodvessels, in the pneumatic chamber, 653, 654, 663; of the respiratory mucous membrane, in astringent inhalations, 149, in cold air inhalations, 100, in inspiration of compressed and expiration into rarefied air, 503
- Blumberg, 369
- Böcker, 22, 294
- Bodily exertion, inhalations with regard to, 100
- Body temperature, in cold inhalations, 110; in compressed air, 671; in rarefied air, 721
- Body weight, in compressed air, 673; in rarefied air, 725
- Boiler apparatus for pneumatic treatment, 376
- Bopp, 64

## BOR

Boracic acid inhalations, 207; in bronchiectasis, 207, 316; in bronchitis putrida, 207, 314; in bronchorrhœa, 207, 314; in diphtheria, 207, 277, 280; in laryngeal abscess, 290; in laryngeal diphtheria, 292; in laryngeal ulcers, 207, 288, 302; in laryngitis, croupous, 296; in laryngitis, ulcerous, 207; in perichondritis laryngea, 305; in pharyngeal ulcers, 283; in pulmonary phthisis, 207, threatening, 339; in tracheitis, 296; in ulcers of the mouth, 283

Botschetschkaroff, 17, 368, 464, 466, 470, 496

Böttcher, 227

Bottini, 613

Bourgeois, 12

Box gasometer for expiration into rarer air, 711

Boyle, 9

Bradley, 367

Brain in compressed air, 664; in rarefied air, 725

Brand, 182

Brauser, 21

Brehmer, 63

Briau, 15, 20, 38, 42

Bricheteau, 185

Brieger, 218, 219

Brockmann, 20, 31, 32

Brodowski, 615

Brofferio, 137

Bromide of potassium inhalations, 137; anesthesia of the pharyngeal and laryngeal mucous membrane by means of, 309; in convulsive cough, 138; in croup, 138; in diphtheria, 138; in irritative cough, 138; in painful catarrh of the respiratory organs, 138; in whooping cough, 138, 319

Bronchi, inhalations of medicinal substances with regard to, 103, 309

Bronchial asthma, v. Asthma

Bronchial blennorrhœa, v. Bronchorrhœa

Bronchial catarrh, acetate of lead inhalations in, 161; *acute*, inhalations in, 309, 340, 534, 686; alkaline sulphides as inhalations in, 180; althæa decoction inhalations in, 340; alum inhalations in, 310, 343; balsamic inhalations in, in compressed air, 532; belladonna inhalations in, 343; benzoate of soda inhalations in, 357; benzoic acid inhalations in, 210; bitter almond water inhalations in,

## BRO

342; camomile infusion inhalations in, 315; carbolic acid inhalations in, 88, 214, 357, in compressed air, 532, (*idem*) 534; carbonate of potassium inhalations in, 310; carbonate of soda inhalations in, 310, 342; cherry laurel water inhalations in, 310, 311; chloride of iron inhalations in, 311, 343; chlorine inhalations in, 205; *chronic*, inhalations in, 310, 342; cold air inhalations in, 113, 310, 340; *complicated with asthma*, pneumatic treatment of 546, 550; *complicated with emphysema*, pneumatic treatment of, 545 deep inspirations in, 579; emollient inhalations in, 121, 340; Ems water inhalations in, 238, 310, 340; glycerine inhalations in, 340; gum arabic inhalations in, 340; hemlock extract inhalations in, 310, 311, 343; hyoseyamus inhalations in, 311, 343; iron, malate of, as inhalation in, 343; lime water inhalations in, 315; morphine inhalations in, 311, 342; nitrogen inhalations in, 248, 250; oil of juniper inhalations in, 343; opium inhalations in, 132, 311, 342; pine oil inhalations in, 343, in compressed air, 532, 534; pine-cone oil inhalations in, 343, in compressed air, 519, 532, 534; pneumatic treatment of, 528, 534, 680, 688; respirator, medicinal, in, 88; sal ammoniac inhalations in, 174, 310, 342, 519, in compressed air, 532, 534, 544; salt, common, inhalations in, 171, 310, 311, 340, 342; salvia oil inhalations in, 343; silver, nitrate of, inhalations in, 310, 343; stimulating alterative inhalations in, 191; sulphate of zinc in, 162; sulphur water inhalations in, 315; sulphuretted hydrogen inhalations in, 254; sweet almond oil inhalations in, 340; tannin inhalations in, 154, 310, 342, 343; tar inhalations in, 315, 343; tepid water inhalations in, 310, 311; turpentine, oil of, inhalations in, 88, 343, in compressed air, 532, 543;

Bronchial croup, inhalations in, 317. V. also Croup

Bronchial diphtheria, carbolic acid inhalations in, 318; carbonate of soda inhalations in, 318; inhalations in, 290, 317; warm water inhalations in, 318. Cf. Diphtheria

Bronchial exudations, solvent inhalations in, 168

## BRO

Bronchial hæmorrhages, alum inhalations in, 261; chloride of iron inhalations in, 261; inhalations in, 260; tannin inhalations in, 261. V. also Hæmoptysis

Bronchial ulcers, solvent inhalations in, 167; opium inhalations in, 132

Bronchiectasis, 315; alum inhalations in, 156, 316; antiputrid inhalations in, 196, 330; balsamic inhalations in, 316; benzoic acid inhalations in, 210; benzoyl dioxide inhalations in, 221; boracic acid inhalations in, 227, 316; carbolic acid inhalations in, 215, 316, 330; chloride of iron inhalations in, 157, 196, 316; compression of thorax in, 610; creosote inhalations in, 316; disinfecting inhalations in, 315, 330; pine-cone oil in compressed air, inhalations in, 519; respirator, medicated, in, 316; salicylic acid inhalations in, 222, 316; solvent inhalations in, 167; tannin inhalations in, 154, 316; tar inhalations in, 200, 316, 330; turpentine, oil of, inhalations in, 316, 330

Bronchitis, astringent inhalations in, 151; benzoate of soda inhalations in, 212; catarrhal, v. Bronchial catarrh; chloride of iron inhalations in, 157; chronic, v. Bronchial catarrh; croupous, v. Bronchial croup, Croup; Ems water inhalations in, 236; eucalyptus inhalations in, 224; *fœtida*, v. Bronchitis putrida; hyoscyamus inhalations in, 133; lime-water inhalations in, 184; morphine inhalations in, 132; sal ammoniac in compressed air inhaled in, 519; solvent inhalations in, 166; sulphur waters, inhalations in, 238; tar inhalations in, 198; turpentine, oil of, inhalations in, 201

Bronchitis putrida, 312; alkaline inhalations in, 196; alum inhalation in, 156, 314; antiputrid and antiseptic inhalations in, 195, 312; astringent inhalations in, 195, 314; balsamic inhalations in, 196; benzoate of soda inhalations in, 212; benzoic acid inhalations in, 210; benzoline inhalations in, 208; benzoyl dioxide inhalations in, 221; boracic acid inhalations in, 207; camomile, infusion of, in, 315; carbolic acid inhalations in, 214, 312, 313; creosote inhalations in, 210; disinfecting inhalations in, 312; eucalyptus oil inhalations in,

## BRO

224; hypermanganate of potassium inhalations in, 207; lime-water inhalations in, 315; respirator for inhalations in, 79, 313; salicylic acid inhalations in, 222; salt, common, inhalations in, 315; stimulating alterative inhalations in, 195; sulphur water inhalations in, 315; tannin inhalations in, 314; tar inhalations in, 196, 200 315; thymol inhalations in, 222, 314; turpentine, oil of, inhalations in, 196, 313, 314. Cf. Bronchorrhœa

Bronchopneumonia, nitrogen inhalations in, 350; respiratory treatment of, 330

Bronchopneumonic ulcerations, alum inhalations in, 356, 358; benzoate of soda inhalations in, 352, 354, 355, 357; carbolic acid inhalations in, 219, 352, 354, 356; chloride of iron inhalations in, 358; copaiva balsam inhalations in, 354; creosote inhalations in, 352, 355; inhalations in, 350; juniper, oil of, inhalations in, 354; nitrogen inhalations in, 321; Peruvian balsam inhalations in, 354; pine oil inhalations in, 354; pneumatic treatment of, 562, 700; salicylic acid inhalations in, 352, 354; salvia, oil of, inhalations in, 354; sulphate of zinc inhalations in, 356; tannin inhalations in, 356; tar inhalations in, 354; thymol inhalations in, 352, 354; Tolu balsam inhalations in, 354; turpentine, oil of, inhalations in, 352, 355

Bronchorrhœa, 312; acetate of lead inhalations in, 161; alum inhalations in, 156, 314, 315; antiseptic inhalations in, 312; astringent inhalations in, 314; benzoate of soda inhalations in, 212, 214; benzoic acid inhalations in, 210; benzoline inhalations in, 208; boracic acid inhalations in, 207, 314; camomile, infusion of, inhalations in, 315; carbolic acid inhalations in, 88, 214, 313; copaiva balsam inhalations in, 312; disinfecting inhalations in, 312; Ems water inhalations in, 236; lime-water inhalations in, 134, 315; Peruvian balsam inhalations in, 312; respirator for inhalations in, 88, 313; salicylic acid inhalations in, 314; salt, common, inhalations in, 315; stimulating alterative inhalations in, 191; sulphate of zinc inhalations in, 162;

## BRÖ

- sulphur waters inhalations in, 315;  
 sulphuretted hydrogen inhalations  
 in, 254; tannin inhalations in, 154,  
 314; tar inhalations in, 198, 312,  
 315; thymol inhalations in, 313;  
 Tolu balsam inhalations in, 312;  
 turpentine, oil of, inhalations in, 88,  
 312, 313; warm water inhalations  
 in, 312  
 Brösicke, 294  
 Brügelmann, 22, 23, 370, 371, 587, 611  
 Bränniche, 615, 691, 705  
 Bruns, 69, 271  
 Brunton, 145  
 Brush apparatus for pulverising medi-  
 cated fluids. 63, 153  
 Buchanan, 616  
 Buchholz, 211, 213, 222  
 Bucquoy, 613  
 Buhl, 273  
 Bunsen, 375  
 Burchard, 320  
 Burns in the air passages, emollient  
 inhalations in, 123  
 Burow, 71  
 Bursi, 370, 371  
 Burrow, 294

**C**ABINET, pneumatic, v. Pneumatic  
 chamber

- Cade oil inhalations, 93, 202; in pul-  
 monary emphysema, 323; in pulmo-  
 nary gangrene, 332  
 Caillens, 10  
 Carus, 19  
 Camomile, infusion of inhalations in  
 angina phlegmonosa, 272; in bron-  
 chorrhœa, 315; in catarrhs, 88; in  
 coryza, 263  
 Camphor combined with ammoniated  
 inhalations, 181, 227; inhalations of,  
 93, 227  
 Cannabis indica inhalations, 135; in  
 asthma, 135, 325; in cough, 135;  
 in pulmonary consumption, 135  
 Cannal, 87, 204  
 Canuet, 616  
 Capillaries in compressed air, 654, 666  
 Carbolic acid inhalations, 93, 212;  
 by means of the respirator, 217;  
 combined with ammoniated inhal-  
 ations, 182; in angina phlegmonosa,  
 273; in bronchial catarrh, 88, 214,  
 357, 532, 534, 543; in bronchial  
 croup, 318; in bronchial diphtheria,  
 318; in bronchiectasis, 215, 316; in  
 bronchitis putrida, 88, 215, 312, 313;

## CAR

- in broncho-pneumonic ulcerations,  
 215, 352, 355, 357; in bronchorrhœa,  
 88, 214, 313; in compressed air, 519,  
 532; in coryza, 182, 264; in diph-  
 theria, 214, 215, 274, 275, 282, 292,  
 293; in inflammation of the lungs,  
 215, 330; in laryngeal abscess, 290;  
 in laryngeal catarrh, 299, 300; in  
 laryngeal croup, 296; in laryngeal  
 phthisis, 214, 306; in laryngeal  
 ulcers, 215, 289, 302, 303; in mycosis  
 of the air passages, 215, 360; in  
 ozæna, 214; in perichondritis laryn-  
 gea, 305; in pharyngeal ulcers, 283;  
 in pulmonary cavities, 215; in pul-  
 monary emphysema, 323, 543; in  
 pulmonary gangrene, 214, 215, 332,  
 333; in pulmonary phthisis, 88, 215,  
 threatening, 339, 352, 355, 357,  
 360, 519; in tracheitis, 296; in ulcers  
 of the oral cavity, 283; in whooping  
 cough, 216, 320, 321  
 Carbonate of potassium inhalations.  
 175; in asthma, 327; in bronchial  
 catarrh, 310; in bronchial croup and  
 diphtheria, 317; in laryngitis, 176,  
 295; in pharyngeal catarrh, 269; in  
 pharyngitis, 176; in tracheal catarrh,  
 176; in tracheitis, 295; in whooping  
 cough, 319  
 Carbonate of soda inhalations, 175; in  
 angina phlegmonosa, 272; in angina  
 tonsillaris, 176; in apex catarrh, 341;  
 in asthma, 327; in bronchial catarrh,  
 310, 342; in catarrhs, 176; in coryza,  
 176, 263; in croup, 176, 318; in  
 diphtheria, 176, 290, 318; in emphy-  
 sema, 323; in laryngeal catarrh, 285,  
 286; in laryngeal tuberculosis, 306;  
 in laryngitis, 176, 289; in oral  
 syphilis, 284; in ozæna, 176; in  
 pharyngeal catarrh, 268, 271; in  
 pharyngeal syphilis, 284; in pharyn-  
 gitis chron. granul. sicca, 175; in  
 pulmonary phthisis, 341, 342; in  
 tracheal catarrh, 176; in whooping  
 cough, 319  
 Carbonic acid, excretion of, through the  
 lungs, in compressed air, 669, in  
 rarefied air, 716. V. also Exchange  
 of gases  
 Carbonic acid inhalations, 251; in  
 asthma, 252; in dyspnœa, 252; in  
 pharyngitis granulosa, 252  
 Cardiac affections, air pressure in the  
 pneumatic chamber with regard to,  
 633; climbing in, 585; deep inspira-  
 tions in, 579; inspiration of rarefied

## CAR

- air in, 494; pneumatic treatment of, 565, 574, 705; solvent inhalations in, 167; sulphur water inhalations in, 238
- Cardiac muscle, weakness of, climbing and walking in, 585
- Cardiac valves, insufficiency of, walking and climbing in, 585
- Carica papaya, inhalations of the juice of, in croup and diphtheria, 186, 296
- Caries, oxygen inhalations in, 246
- Carrière, 140
- Caseous lobular pneumonia, inhalations in, 330; pneumatic treatment of, 700
- Casorati, 369
- Castoreum inhalations, 227
- Catarrhal inflammations, emollient inhalations in, 121
- Catarrhs, v. Respiratory organs, catarrhs of
- Catarrhus pituitosus, acetate of lead inhalations in, 161
- Caustic ammonia, inhalations of, v. Ammoniacal inhalations
- Caustic inhalations, 147; in new formations, 152
- Cauterêts, inhalations of mineral water of, 254
- Cavities, v. Pulmonary cavities
- Celsus, 7, 19, 124
- Chamber, pneumatic, v. Pneumatic chamber
- Champouillon, 20
- Charta antasthmatica, 326
- Cherry laurel water inhalations, 137; in bronchial catarrh, 310, 342; in irritative cough, 137; in painful laryngeal affections, 137; in pulmonary phthisis, 342; in whooping cough, 137
- Cheyne-Stokes's respiratory phenomenon, amyl-nitrite inhalations in, 146
- Children, crying of, 581; inhalations in the case of, 102; pneumatic treatment employed with, 588
- Chlorate of potassium inhalations, 177; in diphtheria, 177, 278, 280; in laryngeal ulcers, 177; in pharyngeal ulcers, 177; in stomacacis, 177; in stomatitis aphthosa, 177; in thrush, 177
- Chloride of ammonium, inhalations of, v. Sal ammoniac inhalations
- Chloride of sodium, inhalations of, v. Common salt inhalations
- Chlorine inhalations, 204; in bronchial

## CLO

- catarrh, 205; in pulmonary gangrene, 205, 330; in pulmonary phthisis, 204. Cf. Chlorine water
- Chlorine water, inhalations of, 93, 206. Cf. Chlorine inhalations
- Chloroform inhalations, 93, 139; anæsthesia by means of, 130, 139; in asthma, 140, 326; in chorea, 140; in convulsive cough, 88, 140; in desquamative pneumonia, 344; in dyspnœa, 140; in epilepsy, 140; in inflammation of the lungs, 140, 328; in pulmonary phthisis, 344; in spasms of the glottis, 140; in tetanus, 140; in whooping cough, 88, 140
- Chloroform poisoning, oxygen inhalations in, 244
- Chlorosis, pneumatic treatment of, 573, 708; oxygen inhalations in, 244
- Chorditis ventricularis and vocalis, astringent inhalations in, 151
- Chorea, chloroform inhalations in, 140
- Christison, 33
- Churchill, 140
- Ciccolini, Sophie, Marquise de, 371, 582
- Cigarettes d'Espic, 134, 325
- Cigars and cigarettes, medicated, 93; of belladonna leaves saturated with saltpetre, 179; of cannabis indica, 135, 325; of digitalis leaves saturated with saltpetre, 179; of nitre paper, 134, 178; of stramonium leaves, 133, saturated with nitre, 179, 325; of tobacco leaves saturated with nitre, 179; with arsenic, 233; with benzoic acid, 210; with iodine, 230; with mercury precipitate, red, 231
- Circulation, in diminution of air pressure on the thoracic surface, 596; in expiration into compressed air, 480; in expiration into rarefied air, 494; in inspiration of compressed air, 461, with expiration into rarefied air, 514; in inspiration of rarefied air, 487; in prolonged expiration, 581; in rarefied air, 718; in right heart, deep inspirations in disturbances of, 579
- Circulatory disturbances, deep inspirations in, 579
- Circulatory organs in prolonged expiration, 581; in the pneumatic chamber, 652
- Clar, 369
- Clarke, 140
- Climbing, respiration in, 585
- Cloches pneumatiques*, v. Pneumatic chamber

## CLO

- Closset, 370  
 Coal dust in the respiratory organs, 30  
 Coal gas inhalations in whooping cough, 319  
 Cod-liver oil, inhalations of, 88  
 Coën, 370  
 Coffee vapour, inhalation of, in coryza, 263  
 Coindet, 615, 716, 719, 726  
 Cold air inhalations, 94, 109; body temperature in, 110; disinfection with regard to, 112; exchange of gases in the lungs in, 115; in acute exanthemata, 114; in apex catarrh, 341; in asthma, 116, 315; in bronchial catarrh, 113, 310, 540; in croup, 116; in diphtheria, 116; in febrile maladies, 88, 114; in hæmorrhages of the respiratory organs, 110, 116; in hyperæmia of the respiratory organs, 113; in infective diseases, 114; in inflammations of the oral cavity, 115; in inflammations of the pharyngeal cavity, 115; in laryngeal catarrh, 113, 285, 299, 340; in laryngeal tuberculosis, 306; in laryngeal ulcers, 303; in laryngitis, 113, 115, 289; in nasal catarrh, 113; in pharyngeal catarrh, 266; in pneumonia, 113; in pulmonary emphysema, 116; in pulmonary phthisis, 115, threatening, 336, 340, 341; in respiratory insufficiency, 115; in tracheal catarrh, 113, 340; in tracheitis, 113, 115; respirator for, 95, 115; secretions in, 111; transudations in, 111; vessels in, 110  
 Cold of inhaled fluids, its action on the respiratory organs, 58  
 Cold water inhalations, 116; expectoration in, 117; in angina tonsillar, 117; in asthma, 119; in catarrhs, 117; in croup, 119; in hæmorrhage of the lungs, 119; in hæmorrhage of the oral cavity, 258; in inflammations of the oral cavity, 117; in laryngeal catarrh, 118, 285, 299; in laryngeal diphtheria, 119; in laryngeal tuberculosis, 306; in pharyngeal catarrh, 117; in pharyngeal hæmorrhages, 258; in pharyngitis, 117; in pulmonary tuberculosis, 119; in tracheal catarrh, 118; in tracheal diphtheria, 119; trachea in, 118  
 Colladon, 11, 612  
 Collardeau, 69, 76  
 Coma, inhalations of caustic ammonia in, 226

## COM

- Common salt inhalations, 171; combined with tannin inhalations, 154; in angina phlegmonosa, 272; in apex catarrh, 342; in asthma, 327; in bronchial catarrh, 171, 310, 311, 340, 342, 343; in bronchitis, putrid, 315; in brouchorrhœa, 315; in coryza, 263; in desquamative pneumonia, 344; in diphtheria, 278; in emphysema, 323; in laryngeal catarrh, 171, 285, 286, 287, 290, 300, 340; in laryngeal tuberculosis, 306; in laryngeal ulcers, 288, 289; in pharyngeal catarrh, 171, 267, 268, 269, 270, 271; in pharyngeal syphilis, 203; in pharyngitis sicca, 166, 171; in pulmonary phthisis, 172, threatening, 336, 340, 342, 343, 344; in syphilis of the oral cavity, 283; in tracheal catarrh, 171, 340; in whooping cough, 319  
 Common salt waters, inhalations of, 237  
 Compressed air, absorption in, 667; absorption of oxygen in, 245, 670; aqueous vapour of, 636; arterial tension in, 657; blood pressure in, 659; blood vessels in, 652, 654, 663; body temperature in, 671; body weight in, 676; brain in, 664; capillaries in, 654, 666; circulating organs in, 653; cranial cavity in, 664; evacuation of the intestines in, 663; exchange of gases in the lungs in, 669; excretion of carbonic acid in, 669; excretion of urea in, 676; expiration from, into rarer, 711; expiration into, v. Expiration into compressed air; fat formation in, 674; gases in, and modification of their relative amounts, 418; generation of heat in, 671; hæmorrhoidal hæmorrhage in, 664; heart in, 652; heat of, 636; inspiration of, v. Inspiration of compressed air; intestinal gases in, 643; liver in, 664; lungs in, 642, with regard to the elasticity of their tissue, 679; lymphatics in, 666; menstrual discharge in, 664; moisture in, 636, 637; muscular strength in, 679; nervous system in, 642; nutrition in, 676; organ of hearing in, 640; organs of sense in, 640; oxydation in the organism in, 670; pulse in, 655; respiration in, 647; respiratory movements in, 647; respiratory organs in, 642; secretion of urine in, 663; secretions in, 667;

## COM

sense of smell in, 642; sense of taste in, 642; spleen in, 664; therapeutic employment of, v. Pneumatic therapeutics; thorax in, 650; tissue change in, 676; transition from, into rarer, more rapid, 681; veins in, 654, 666; vertebral canal in, 665; vital capacity in, 645, 650; voice in, 641

Compression of air, effect upon it, 635; on the thorax, influence of, 607

Congestive hyperæmia in the lungs, pneumatic treatment of, 572

Conium maculatum, inhalations of, v. Hemlock inhalations

Conner, 139

Constitutionally acting remedies, inhalations of, 227

Constriction, air pressure in pneumatic chambers with regard to, 631

Convalescence, oxygen inhalations in, 245

Convulsive conditions in the respiratory organs, inhalations in nerve-exciting, 225, of camphor, 227

Convulsive cough, bromide of potassium inhalations in, 138, chloroform inhalations in, 88, 140; ether inhalations in, 88; narcotic inhalations in, 129; opium inhalations in, 132; respirator, medicated, in, 88; sodium and potassium sulphides, inhalations in, 180

Copaiva balsam inhalations, 93, 203; in bronchopneumonic ulcerations, 354; in bronchorrhœa, 312; in laryngeal ulcers, 203, 302; in pharyngeal catarrh, 88; in phthisis, 354; in tracheal catarrh, 88; in tracheal ulcers, 203

Copland, 200

Corrigan, 87

Corrosions, emollient inhalations after, 123

Corrosive ulcers of the air passages, inhalations in, 356

Coryza, acetic acid inhalations in, 264; acute, inhalations in, 263; althœa decoction inhaled in, 263; ammoniated inhalations in, 182, 264; camomile infusion inhalations in, 263; carbolic acid inhalations in, 264; carbonate of soda inhalations in, 176, 263; chronic, inhalations in, 264; coffee vapour inhalations in, 263; cold air inhalations in, 113; Ems water inhalations in, 263; gum emulsion inhaled in, 263; hot water vapour inhalations in, 263; lime

## CRO

blossom infusion inhaled in, 263; milk vapour inhalations in, 263; sal ammoniac inhalations in, 264; salt, common, inhalations in, 263; sambucus infusion inhalations in, 263; spirits of wine inhalations in, 182, 264; sulphuretted hydrogen inhalations in, 254; tea infusion inhalations in, 254; tepid water inhalations in, 265

Cottureau, 12, 87

Cough, cannabis indica inhalations in, 136; caused by inhalations, 28. V. Convulsive cough, Cough, irritative

Cough, irritative, bromide of potassium inhalations in, 128; cherry laurel inhalations in, 137; induced by inhalations, 28; marsh mallow decoction, vapours of, in compressed air inhaled in, 519; narcotic inhalations in, 129; oil inhalations in, 125; opium inhalations in, 131; pine shoots, infusion of, used as inhalations in, 202; solvent inhalations in, 166

Courtois, 12

Crabler, 520

Cranial cavity in compressed air, 664

Creosote inhalations, 93, 209; in bronchiectasis, 316; in bronchitis putrida, 210; in bronchopneumonic ulcerations, 352, 355; in diphtheria, 280; in emphysema, 323; in laryngeal ulcers, 288, 302; in pneumomycosis, 360; in pulmonary gangrene, 332; in pulmonary phthisis, 209, 352, 355, 360

Crichton, 198

Crighton, 12, 19

Croce-Spinelli, 243, 721, 726

Cron, 371, 519, 520, 526, 534, 539, 544, 556, 611

Croup, bromide of potassium inhalations in, 138; bromine inhalations in, 206; carbolic acid inhalations in, 318; carbonate of lithium inhalations in, 176; carbonate of potassium inhalations in, 317; carbonate of soda inhalations in, 176; carica inhalations in, 186; chloride of iron inhalations in, 157; cold air inhalations in, 116; cold water inhalations in, 119; emollient inhalations in, 122; inhalations in, 81, 317; lactic acid inhalations in, 185, 317; lime-water inhalations in, 183, 317; neurine inhalations in, 317; oxygen inhalations in, 243; papayotine in-



## CRU

- halations in, 317; pneumatic treatment of, 528, by diminution of air pressure on the thorax, 605; tannin inhalations in, 155; tetraethyl-ammonium-hydroxyde as inhalation in, 317; tetramethyl-ammonium-hydroxyde as inhalation in, 317. V. also Laryngitis, croupous
- Cruveilhier, 134
- Crying of children, 581
- Cube, 17, 18, 368, 373, 375, 388, 439, 440, 442, 516, 519, 520, 555, 611
- Cuprum sulfuricum, inhalations of, v. Sulphate of copper inhalations
- Curschmann, 23, 88, 90, 91, 210, 215, 313, 352, 354

## DA COSTA, 136, 162, 315

- Dagoumer, 247
- Dalton, 239, 240
- Danneey, 134, 179
- Darwin, 63, 99, 153
- Davis, 370
- Davy, 12
- Declamation as connected with respiration and circulation, 583
- Decoction of pine bark, vapours of, combined with compressed air, 519. V. *infra*, Pine-cone decoction
- Delirium tremens, nitrous oxide inhalations in, 145
- Delore, 20
- Demarquay, 15, 20, 38, 40, 41, 79, 155, 232, 247, 266, 293
- Demartis, 135
- Demme, 326
- Deport, 136
- Desquamative pneumonia, inhalations in, 330, 343; pneumatic treatment of, 344, 562, in the pneumatic chamber, 698
- Devay, 613, 692, 705
- De Vigo, 8, 231
- Diarrhœa removed by inhalations of chloride of iron, 157
- Diemerbrück, 30
- Diet, respiratory, 87
- Digitalis, leaves of, saturated with nitre, used for smoking, 179
- Dioxybenzol, inhalations of, 217
- Diphtheria, alum inhalations in, 156; ammonium bases as inhalation in, 294, 317; antiseptic inhalation in, 195; boracic acid inhalations in, 207, 277, 281, 292; bromide of potassium inhalations in, 138; bromine inhalations in, 206; pyrocatechin inhalations in, 221; *of the bronchi*, in-

## DIS

- halations in, 317; carbolic acid inhalations in, 214, 215, 274, 275, 282, 292, 293, 318; carbonate of potassium inhalations in, 317; carica papaya juice inhaled in, 295; chlorate of potassium inhalations in, 177, 278, 280; chloride of iron inhalations in, 157; cold air inhalations in, 116; cold water inhalations in, 119; disinfecting inhalations in, 195; emollient inhalations in, 122; eucalyptus oil inhalations in, 224, 280; hot water vapour inhalations in, 278; hydroquinine inhalations in, 221; hypermanganate of potassium inhalations in, 207, 280; inhalations in, 81, 273; jaborandi leaves in, 280; lime-water inhalations in, 183, 280, 290, 292, 294, 317; *of the larynx*, inhalations in, 290; carbonate of lithium inhalations in, 176, 290, 317; creosote inhalations in, 280; lactic acid inhalations in, 185, 280, 290, 292, 294, 317; salt, common, inhalations in, 278; solvent inhalations in, 294; *of the oral cavity*, inhalations in, 273; benzoate of soda inhalations in, 211, 277, 280; carbonate of soda inhalations in, 176, 290, 318; neurine inhalations in, 186, 294, 317; papayotine inhalations in, 188, 295, 317; pilocarpine in, 280; pneumatic treatment of, 528; *of the pharyngeal cavity*, inhalations in, 273; resorcin inhalations in, 221; salicylic acid inhalations in, 222, 278, 280; silver, nitrate of, inhalations in, 159; tannin inhalations in, 155; tetraethyl-ammonium-hydroxide inhaled in, 294, 317; tetramethyl-ammonium-hydroxide inhaled in, 294, 317; thymol inhalations in, 223, 280; warm water inhalations in, 318
- Diseases of circulatory organs, pneumatic treatment of, 565
- Disinfecting inhalations, 93, 194; in bronchiectasis, 315, 330; in bronchitis putrida, 312; in bronchorrhœa, 312; in diphtheria, 195; in empyema, perforating, 196; in laryngeal abscess, 290; in laryngeal cancer, 193; in laryngeal catarrh, 299; in laryngeal phthisis, 306; in laryngeal ulcers, 193, 194, 301; in perichondritis laryngea, 304; in pharyngeal ulcers, 194; in pneumomycosis, 197; in pulmonary consumption, 197, threatening, 338, 351; in pulmonary

## DIS

- gangrene, 193, 196; in tracheal cancer, 193
- Disinfection, by astringent inhalations, 149; by balsamic inhalations, 203; by benzoate of soda, 211; by benzoic acid inhalations, 210; by hypermanganate of potassium inhalations, 207; cold air inhalations in connection with, 112; of the pneumatic apparatus, 439
- Diving-bell, 618
- Dobell, 17, 367, 369, 375
- Dohrn, 318
- Domansky, 18, 368, 519, 520
- Donders, 241
- Doses of the remedies to be inhaled, 104
- Double apparatus for pneumatic treatment (V. Cube's), 388. (Weil's) 393
- Double ventilator by Geigel and Mayr, v. Pneumatic apparatus (Geigel's)
- Drosdoff, 368, 464, 465, 470, 496, 500
- Dubreuil, 13, 612
- Ducrocq, 17, 369, 444, 462, 470, 478
- Ducros, 182
- Dührssen, 17, 368, 575
- Durand-Fardel, 16, 20
- Duration of inhalations, 104, 108; sittings in the pneumatic chamber, 632
- Dust, diseases of the lung from inhalation of, 34
- Dust, penetration of, into the respiratory organs, 30
- Dyspnœa, carbonic acid inhalations in, 252; chloroform inhalations in, 140; ether inhalations in, 140; expiration into rarefied air in connection with, 459, 460; inspiration of compressed air with expiration into rarefied air in connection with, 513; nerve-exciting inhalations in, 225
- L**AUX-BONNES, inhalations of the mineral water of, 238, 254
- Eberle, 140
- Ebers, 209
- Ebert, 98
- Echinococcus of the lungs, oil of eucalyptus inhalations in, 224
- Eclampsia, amyl nitrite inhalations in, 146
- Edlund, 371
- Eichhorst, 722
- Eilsen, gas baths and inhalatorium at, 253, 254
- Elder flowers used for inhalations, v. Sambucus

## ETH

- Elevated health resorts, 710, 720, 723, 729
- Emollient inhalations, 119; in bronchial catarrh, 121, 340; in burns, 123; in catarrhal inflammations, 121; in corrosions, 123; in croup, 122; in desquamative pneumonia, 345; in diphtheria, 122; in inflammation of the oral cavity, 121; in inflammatory processes, 119, 121; in laryngeal catarrh, 121, 299, 340; in laryngeal ulcers, 303; in laryngitis, 121; in parenchymatous inflammations, 121; in pharyngeal catarrh, 267, 269; in pharyngitis, 121, hyperplastica, 272; in phlegmonous inflammations, 121; in pseudo-membranous inflammations, 122; in pulmonary phthisis, 340, 345; in scalds, 123; in tracheal catarrh, 121, 340; in ulcerative processes, 122; in wounds, 123
- Emphysema, v. Pulmonary emphysema
- Emphysema senilis, pneumatic treatment of, 544
- Empyema, perforating, antiputrid inhalations in, 196; pneumatic treatment of, 551, 554
- Ems, carbonic acid inhalations there, 252
- Ems water inhalations, 234; in apex catarrh, 341; in bronchial catarrh, 236, 310, 340; in bronchitis, 236; in bronchorrhœa, 236; in coryza, 263; in desquamative pneumonia, 344; in laryngeal catarrh, 236, 285, 299, 340; in laryngo-tracheitis, 236; in pharyngeal catarrh, 235, 336, 340, 344; in pharyngitis, 236; in pulmonary emphysema, 323; in pulmonary phthisis, 236, threatening, 336, 340, 344; in tracheal catarrh, 236, 240
- 'Entschleussungs'-symptoms, 682
- Epiglottis, inhalations with regard to, 24. V. also Epiglottitis
- Epiglottitis, astringent inhalations in, 151
- Epilepsy, amyl nitrite inhalations in, 146; chloroform inhalations in, 140
- Erdmann, 19
- Espic cigarettes, 134, 325
- Ether, penetration of, into the respiratory organs, 47
- Ether inhalations, 88, 139, 226; anæsthesia by means of, 130, 139; in apnœa, 140; in asphyxia, 226; in asthma, 140, 326; in convulsive cough, 88; in dyspnœa, 140; in

## ETH

- hysterical affections, 226; in inflammation of the lungs, 141; in phthisis, 140; in syncope, 226; in whooping cough, 88
- Ethereal oils, inhalation of, in desquamative pneumonia, 344; in febris nervosa stupida, 88; penetration of, into the respiratory organs, 47
- Ethyl bromide inhalations, 138; bromine inhalations, 93, 206, in croup, 206, in diphtheria, 206, in pulmonary gangrene, 332
- Ethyl ether (nitrous), inhalations of, v. Amylnitrite inhalations
- Ethyl iodide, inhalations of, in asthma, 326
- Ettmüller, 131
- Eucalyptol inhalations, 93, 223; in bronchitis, 224; in diphtheria, 224, 280; in echinococcus of the lungs, 224; in laryngeal ulcers, 302; in pulmonary phthisis, 224
- Eucalyptus oil, inhalations of, v. Eucalyptol inhalations
- Eulenburg, 145, 178
- Euzet-les-Bairs, inhalations of the mineral water there, 238, 254
- Exanthemata, acute, cold air inhalations in, 114
- Exchange of gases in the lungs, air pressure, altered, with regard to, 505; in cold air inhalations, 115; in compressed air, 669; in deep inspiration, 578; in expiration into compressed air, 449; in expiration into rarefied air, 457; in inspiration of compressed air, 447; in inspiration of rarefied air, 452; in nitrogen inhalations, 249; in oxygen inhalations, 239; in rarefied air, 716; respiration with regard to, 579
- Expectoration, cold water inhalations with regard to, 117; with balsamic inhalations, 203; with benzoic acid inhalations, 210; with compression of thorax, 609; with inspiration of compressed air, 448; with prolonged expiration, 581; with saltpetre inhalation, 178, and v. Sputa
- Expiration, abdominal, 577; from denser into rarer air, 711; in condensed air, 647; in expiration into rarefied air, 455; influenced by thoracic compression, 608; in inspiration of compressed air, 446, 467; in rarefied air, 715; prolonged, 580, respiratory and circulatory organs in, 681

## FAT

- Expiration into compressed air, 372, 448; after inspiration of compressed air, 510; after inspiration of rarefied air, 509; arterial tension in, 482; circulation in, 480; exchange of gases in the lungs in, 450; expiratory muscles in, 451; heart in, 480; pressure in the aortic system in, 481; pulse in, 481, 485; secondary effect of, 487
- Expiration into rarefied air, 372, 454, 498; after inspiration of compressed air, 511; aortic system in, 495; arterial tension in, 495, 499, 502; blood pressure in, 496; blood vessels of the respiratory mucous membrane in, 503; circulation in, 495; counter-indications, 523; dyspnoea in connection with, 460; exchange of gases in the lungs in connection with, 451; expiration in, 455; expiratory muscles in, 458; heart in, 495; in anæmia of the pulmonary circulation, 573; in apex catarrh, 341, 560; in asthma, 550, 714; in bronchial catarrh, 529, 533; in cardiac affections, 565, 574; in cavities of the lungs, 564; in desquamative pneumonia, 563; indications for, 522; in diseases of the circulatory organs, 565; in empyema, 554; in inflammation of the lungs, 329; in insufficiency of the aortic valves, 570; in insufficiency of the tricuspidal valve, 574; in phthisical habit, 557; in pleuritis, 552; in pulmonary emphysema, 456, 460, 537, combined with compression of the thorax, 610, 714; inspiratory muscles in, 458; lungs in, 455, 459, 495; pulmonary ventilation in, 497; pulse in, 498, 571; residual air in, 456; secondary effect of, 503; thorax in, 455, 458; veins in, 495; vital capacity in, 459; with thoracic compression, 610
- Expiratory force, in expiration into rarefied air, 458; inspiration of compressed air with regard to, 447
- Expiratory muscles, in expiration into compressed air, 451; in expiration into rarefied air, 458
- FACHINGEN, inhalations of the mineral water of, in pulmonary emphysema, 323
- Fantini, 22
- Fat formation in compressed air, 674

## FAT

Fatty heart, walking and climbing in, 585; pneumatic treatment of, 572  
 Favrot, 179  
 Febrile diseases, cold air inhalations in, 88, 114  
 Febris nervosa stupida, inhalations in, 88  
 Feldbausch, 23, 91, 92, 339  
 Fenoglio, 370, 571, 572  
 Ferrum sesquichloratum, inhalations of, v. Iron, chloride of, inhalations; sulphuricum inhalations, 163  
 Fibrinous exudations in larynx and trachea removed by solvent inhalations, 168  
 Fieber, 16, 21, 38, 39, 41, 119, 125, 132, 136, 155, 156, 161, 162, 202, 319  
 Fihlene, 145, 146  
 Finker, 375  
 Finkler, 375, 407, 516  
 Fir-leaf oil inhalations, 93, 202; in apex catarrh, 341; in bronchial catarrh, 343, in compressed air, 519, 530, 532; in bronchiectasis, 519; in broncho-pneumonic ulcerations, 354; in emphysema, 323; in paresis of vocal cords, 308; in phthisis, 341, 343, 354  
 Fischer, 614  
 Fischl, 527  
 Flank breathing, 576  
 Fleury, 613  
 Flint, particles of, in the respiratory organs, 30  
 Flubé, 15  
 Fluids, inhalations of, and penetration into the respiratory organs, 25, (id.) 35; action of, 54; and absorption in, 56; and their temperature with regard to the respiratory organs, 57; apparatus for, 61; their temperature, 80; cf. Inhalations, Inhalatory apparatus  
 Fluids, pulverisation of, and their penetration into the respiratory organs 25, (id.) 29, (id.) 35, apparatus for, 57; by steam, 78; (id.) 67, temperature in these, 78, (id.) 78, (id.) 79  
 Foerster, 21  
 Foley, 614, 634, 642, 655, 664, 665, 680, 682, 683, 707  
 Fontaine, 616, 617, 630  
 Foreign bodies in the sputa after inhalations of them, 42, 51; in the urine after inhalation of, 42; penetration of, into the respiratory organs, 29

## GER

Forlanini, 371, 617  
 Formic acid, inhalations of, 185  
 Förster, 176  
 Forster, Von, 218, 219  
 Fothergill, 10  
 Fourcroy, 10  
 Fournié, 15, 21, 40, 63  
 Fracastori, 231  
 Francœur, 612  
 François, 613, 656, 664, 665, 681, 707  
 Frank, 17, 369, 469, 470, 473, 476, 478, 481, 486, 489, 498, 500  
 Fränkel, 17, 71, 250, 259, 368, 375, 416, 439, 440, 618, 679, 722, 723, 725  
 Franzenbad, carbonic acid inhalations at, 252  
 Frivi, 177  
 Frontal catarrh, sulphur waters, inhalations of, in, 254  
 Fuchs, 172  
 Fumigations with cannabis indica, 135; with mercury, 231; with narcotic remedies, 131; with nitre, v. Nitre paper  
**G**ALENUS, 8, 19, 83, 124, 181, 233  
 Galilei, 9  
 Gamgee, 145  
 Gangrene of the lung, v. Lungs, gangrene of; *senile*, oxygen inhalations in, 246  
 Gas inhalations, 50, 238; apparatus for, 93  
 Gas poisonings, oxygen inhalations in, 244  
 Gases added to compressed air for inspiration, 351, 518; their penetration into the respiratory organs, 25, 29, 46  
 Gasometer, apparatus for pneumatic treatment on the principle of, 380  
 Gay-Lussac, 719  
 Gebhard, 253  
 Geigel, 17, 329, 370, 373, 375, 417, 434, 437, 439, 441, 445, 516, 526, 543, 545, 546, 548, 549, 554, 558, 561, 563, 564  
 Geipel, 370  
 Gent, 616  
 Gerhardt, 38, 39, 41, 56, 138, 157, 160, 175, 316, 319, 457, 587, 589, 609, 610  
 German tinder, saturated with nitre, inhalation of the vapours thus evolved, 179

## GEY

- Geyer, 368  
 Gieseler, 12, 172  
 Gimbert, 223  
 Gindrod, 613  
 Giuliani, 369  
 Glaisher, 613, 718  
 Glottis, inhalations with regard to, 24, 26  
 Glottis, œdema of, tannic acid inhalations in, 155  
 Glottis, spasm of, chloroform inhalations in, 140; camphor inhalations in, 227; sulphur water inhalations in, 238  
 Glycerine, tannic acid dissolved in, for the purpose of inhalation, 155  
 Glycerine inhalations, 125; in bronchial catarrh, 340; in desquamative pneumonia, 344; in laryngeal catarrh, 340; in pharyngeal catarrh, 269; in pharyngeal ulcers, 283; in pulmonary phthisis, 340, 344; in tracheal catarrh, 340; in ulcers of the oral cavity, 283  
 Glycyrrhiza used for inhalations, 125  
 Goldschmied, 63  
 Göschen, 616  
 Gottstein, 23  
 Gout, oxygen inhalations in, 244  
 Graham, 33, 211  
 Grandidier, 254  
 Gratiolet, 16, 39  
 Grell, 583  
 Griesinger, 504  
 Grimaud, 135  
 Guérard, 613  
 Guerike, Von, 9  
 Guichard, 617  
 Guidi, 231  
 Gum arabic inhalations, 125; combined with balsamic inhalations, 204; in bronchial catarrh, 340; in coryza, 263; in laryngeal catarrh, 340; in pharyngeal ulcers, 283; in pulmonary phthisis, 340; in tracheal catarrh, 340; in ulcers of the oral cavity, 283  
 Günther, 19  
 Guthrie, 145  
 Gutmann, 23  
 Guttman, 370  
 Guyot, 179

## HAAB, 220

- Habituating of the respiratory organs to irritations, 28  
 Habitus phthisicus, pneumatic treatment in, 556, 696

## HEA

- Hadra, 618, 678, 679  
 Hæmoptysis, acetate of lead inhalations in, 161; acetic acid inhalations in, 88; alum inhalations in, 156, 261; chloride of iron inhalations in, 157, 261; cold water inhalations in, 119; creosote inhalations in, 210; ice inhalations in, 88; in compression of the thorax, 610; inhalations in, 81; pneumatic treatment of, 572, in the pneumatic chamber, 701; respirator, medic., employed in, 88; styptic inhalations in, 255; tannic acid inhalations in, 88, 155; tannin inhalations in, 155  
 Hæmorrhages, astringent inhalations in, 151; from the bronchi, v. Bronchial hæmorrhages; from the lung, v. Hæmoptysis; from the nostril, v. Nostrils, hæmorrhages from; from the pharyngeal cavity, v. Pharyngeal hæmorrhages; from the respiratory organs, v. Respiratory organs, hæmorrhages of; from the trachea, v. Tracheal hæmorrhages; in the oral cavity, v. Mouth, hæmorrhages from; of the larynx, v. Laryngeal hæmorrhages  
 Hæmorrhoidal hæmorrhage in compressed air, 664; pneumatic treatment of, 664; suppression of, 664  
 Hager, 182  
 Halitus, 9  
 Hamel, 11, 612  
 Hamilton, 144, 145  
 Hänisch, 17, 369, 480, 516, 520, 531, 539, 567, 568, 569  
 Härling, 248  
 Harwood, 181, 227  
 Hastings, 226  
 Haughton, 613  
 Hauke, 17, 94, 368, 375, 376, 388, 517, 519, 528, 587, 588, 589, 591, 595, 596, 598, 599, 601, 604, 605, 607  
 Hausmann, 23, 90, 91, 199, 215  
 Hay asthma, tobacco inhalations in, 136  
 Headache, nitrous oxide inhalations in, 144. V. also Hemicrania  
 Hearing, affections of, air pressure in pneumatic chamber with regard to, 633  
 Hearing, organ of, in compressed air, 640  
 Heart, in compressed air, 652; in expiration into compressed air, 480; in expiration into rarefied air, 495; in

- HEA
- inspiration of compressed air, 461, 479, with expiration into rarefied air, 514; in inspiration of rarefied air, 487
- Heat, formation of, in compressed air, 671
- Heat-withdrawing remedies, inhalations of, 109
- Helbing, 20
- Helft, 248, 252, 254
- Helmke, 138, 319
- Hemicrania sympathico-tonica, angio-spastica, amyl nitrite inhalations in, 146
- Hemlock inhalations, 133; in bronchial catarrh, 310, 311, 343; in laryngeal hyperæsthesia, 133; in pulmonary phthisis, 343; in tracheal hyperæsthesia, 133
- Henshaw, 8, 710
- Hermann, 143
- Herpetic affections, mercury inhalations in, 232
- Hervier, 672
- Heubner, 34
- Hippocrates, 7, 19, 83, 124
- Hirt, 22, 34
- Hirzel, 14, 20
- Hoarseness, ammoniated inhalations in, 181; camphor innalations in, 227
- Högyes, 368, 375
- Holm, 41, 371
- Homer, 6
- Hoppe, 13
- Hoppe-Seyler, 22, 213, 238, 241, 617, 682, 721
- Hot water vapours, inhalations of, in coryza, 263; in diphtheria, 278
- Huette, 11, 229, 239
- Hufeland, 11, 19, 131
- Hutchinson, 651
- Hydrargyrum bichloratum corrosivum, inhalation of, v. Mercuric chloride inhalations
- Hydroconion, 13, 66, 106
- Hydrogen gas, inhalations of, 251
- Hydroquinone, inhalations of, 217
- Hyoscyamus inhalations, 132; in asthma, 325; in bronchial catarrh, 311, 343; in bronchitis, 133; in emphysema, 323; in pulmonary phthisis, 133, 343; in whooping cough, 133, 319
- Hyperæmia of the pulmonary circulation, pneumatic treatment in, 566
- Hyperæsthesia of the respiratory mucous membrane, conium inhalations in, 133
- INS
- Hypermanganate of potassium inhalations, 207; disinfection by means of, 207; in aphthous processes of the oral cavity, 207; in diphtheria, 207, 280; in fetid breath, 207; in laryngeal ulcers, 207; in pharyngeal ulcers, 207; in pulmonary gangrene, 207, 332; in putrid bronchitis, 207; in whooping cough, 207
- Hysteria, amyl nitrite inhalations in, 146; ether inhalations in, 226; nitrous oxide inhalations in, 144; respiratory disturbances in nerve-exciting inhalations in, 225
- I**CE, inhalations of, 88
- Ice-water inhalations, 116; in hæmorrhages of the oral cavity, 258; in hæmorrhages of the pharyngeal cavity, 258; in laryngitis, parenchymatous, 289; in pharyngeal catarrh, 267; in pharyngitis, 272
- Indian hemp, inhalations of, v. Cannabis indica inhalations
- Infectious diseases, respirator worn in, 92
- Infective diseases, benzoate of soda inhalations in, 211; cold air inhalations in, 114; rarefied air with regard to, 211
- Inhalations, of acetum aromaticum, 226; of acetum aromaticum, 88; and of other substances under their several headings
- Inhalatory apparatus, 43, 61; Bergson's, 44, 64, 78, 79, 105, 106, 117; Darwin's, 99; for gases, 93; for medicinal fluids, 61; for solid bodies, 98; for vapours, 82; Lewin's, 44, 63, 67, 85, 99, 105, 173; Mandl's, 84; Matthieu's, 44, 64, 78, 79, 117; Niemeyer's, 94; Oertel's, 72; Richardson's, 67, 294; Sales-Girons', 44, 61, 78, 80, 87, 105, 106; Schnitzler's, 63; Siegle's, 45, 68, 80, 106; Waldenburg's, 63, 84. Cf. Respirator Inhalatory mask, 88, 352, 355;
- Inselbad, nitrogen inhalations at, 248
- Insomnia, nitrous oxide inhalations in, 144
- Inspiration of compressed air, 372; after thoracocentesis, 563; arterial tension in, 476; blood pressure in, 461, 463, 467, 477; blood vessels of the respiratory mucous membrane in, 503; circulation in, 461, with expiration into rarefied air, 514; *counter-indica-*

## INS

tions, 523; exchange of gases in the lungs during, 447; expectoration in, 448; expiration in, 446, 467; heart in, 461, 479, with expiration into rarefied air, 514; in apex catarrh, 341, 560; in asphyxia, 526, 631; in asthma, 528, 547; in bronchial catarrh, 529, 553, 554; in cardiac affections, 565; in cavities in the lungs, 564; in chlorosis, 573; in constrictions, 631; in croup, 528; in desquamative pneumonia, 562; *indications for*, 521; in diphtheria, 528; in diseases of the circulatory organs, 565; in empyema, 554; in insufficiency of the aortic valves and stenosis, 570; in insufficiency of the mitral valve and stenosis, 567; in laryngeal stenosis, 527; in menstrual disturbances, 573; in meteorism, 631; in obesity, 631, 633; in obstruction of the air passages, 525; in paralytic thorax, 524; in peribronchitis, 561; in phthisical habit, 556; in pleuritis, 526, 552; in pulmonary cirrhosis, 529; in pulmonary hyperæmia through congestion, 573; in pulmonary infiltrations, inflammatory, 561; in respiratory insufficiency, 524; inspiration in, 442; in suppression of hæmorrhoidal flux, 573; in tracheal stenosis, 527; lungs in, 441, 465; pulmonary ventilation in, 447; pulse in, 463, 468, 477; respiration in, 441, with expiration into rarefied air, 511; secondary effect of, 474, 479; secretion of urine in, 555; thorax in, 443; veins in, 478; vital capacity in, 445, with expiration into rarefied air, 513; with addition of carbolic acid, 519, 532; with amyl nitrite, 519; with decoction of oak bark, 519; with decoction of pine bark, 519; with decoction of pine cones, 519; with expiration into rarefied air, 509-511; with oil of turpentine, 519; with sal ammoniac, 519, 532; with tar, 519; with thoracic compression, 611; with vapours of decoction of althæa, 519; Cf. Pneumatic treatment

Inspiration of medicinal substances, v. Inhalations; of air of different densities, v. Inspiration

Inspiration of rarefied air, 372, 451, 487; aortic system in, 488; arterial tension in, 488, 489, 492; blood pressure in, 489; circulation in, 488;

## IRO

exchange of gases in the lungs in, 452; heart in, 487; in anæmia of the pulmonary circulation, 472; in cardiac affections, 494, 574; inspiratory muscles in, 453; pulmonary ventilation in, 452; pulse in, 488, 491; secondary effect of, 494; vital capacity in, 453; with expiration into compressed air, 509

Inspiratory act, deep, 594, in circulatory disturbances in the right heart, 579; in bronchial catarrh, pulmonary anæmia, pulmonary phthisis, 579; forced, dilatation of the thorax by, 596; in condensed air, 647; in diminution of air pressure on the thoracic surface, 575; in inspiration of compressed air, 442; in rarefied air, 715

Inspiratory air, warming of, in the pneumatic method, 517

Inspiratory muscles in expiration into rarefied air, 459; in inspiration of rarefied air, 453

Insufficiency of the aortic valves, pneumatic treatment of, 570; of the mitral valve, v. Mitral valve insufficiency; of the tricuspid valve, pneumatic treatment of, 574

Insufficient fulness of the pulmonary circulation, pneumatic treatment in, 573. V. Lung, anæmia of

Intestinal gases, in compressed air, 643; in rarefied air, 716

Iodide of potassium inhalations, 228; in desquamative pneumonia, 345; in laryngeal catarrh, 287; in pharyngeal catarrh, 269; in pharyngeal syphilis, 284; in syphilis of the oral cavity, 284

Iodine cigars, 230, 545

Iodine inhalations, 93, 228; combined with carbolic acid inhalations, 215; in desquamative pneumonia, 345; in laryngeal catarrh, 287; in laryngeal phthisis, 229; in laryngitis, 229; in pharyngeal ulcers, 283; in pharyngitis, 229; in pulmonary phthisis, 215, 229, 305, 549; in syphilis of the respiratory organs, 229; in ulcers of the oral cavity, 283

Iodine, tincture of, inhalations, 228; in pharyngeal catarrh, 269

Iodoform, inhalations of, 93

Iron, chloride of, inhalations, 157; diarrhœa removed by, 157; in aphonia, hysterical, 157; in bronchial hæmorrhages, 261; in bronchial

## IRO

- catarrh, 311, 343; in bronchiectasis, 157, 196, 316; in bronchitis, 157; in broncho-pneumonic ulcerations, 358; in croup, 157; in diphtheria, 157; in hæmorrhages of the oral cavity, 258; in hæmorrhages of the pharyngeal cavity, 258; in hæmorrhages of the respiratory organs, 158, 358; in laryngeal catarrh, 157, 287; in laryngeal ulcers, 303; in pharyngeal catarrh, 157, 270; in pulmonary gangrene, 157; in pulmonary hæmorrhage, 157, 261, 358; in pulmonary phthisis, 157, threatening, 236, 343, 358; in whooping cough, 319
- Iron, oxide of, penetration of, into the lungs, 34
- Iron, protosulphate of, inhalations, 163
- Iron, tincture of malate of, inhalations of, 163, for averting pulmonary phthisis, 333, in bronchial catarrh, 343
- Ischl, inhalations of mineral water at, 237
- J**ABORANDI in diphtheria, 280
- Jaeger, 22
- Jakobson, 617, 661, 662, 665
- Jenner, 124
- Jor-hheim, 22
- Johnston, 35
- Josephson, 614, 617, 711, 713
- Jourdanet, 614, 617, 715, 716, 719, 721, 726
- Juiper oil inhalations, 93, 202; in bronchial catarrh, 343; in broncho-pneumonic ulceration, 354; in emphysema, 323; in pulmonary phthisis, 343, 354
- Junker, 328
- Junod, 13, 209, 612, 642, 654, 656, 710

- K**ALI arsenicosum, inhalations of, cf. Arsenic inhalations
- Kali nitricum, inhalations of, v. Nitre inhalations
- Kalium iodatum, inhalations of, v. Iodide of potassium inhalations
- Kalium sulfuratum, inhalations of, 180
- Katschenowsky, 673
- Kanlich, 587, 588
- Kelemen, 371, 533, 555
- Keller, 319
- Kemster, 214, 313
- Kissingen, inhalations of the mineral waters of, 237, (in emphysema) 323

## LAR

- Klebs, 211, 359, 361
- Kleschinsky, 230
- Klikowitsch, 144
- Knauer, 617
- Knauff, 22, 34
- Knauthe, 369, 440, 478, 643, 652, 680, 714
- Knight, 35
- Knoll, 371, 481, 484, 490, 491, 584
- Kochs, 375, 407
- Köhler, 203, 312
- Kohlschütter, 23, 250, 345, 346, 347, 348, 349, 350, 351, 352
- Kondratjew, 655
- Körner, 23
- Kowalewsky, 370
- Kretzschmar, 319
- Kriemer, 137
- Kronthal, carbonic acid inhalations there, 252
- Kryszka, 615
- Küchenmeister, 21, 183, 185
- Kühn, 19
- Küss, 370
- Kussmaul, 22, 35, 504
- Kuster, 252
- Kyphosis, walking and climbing in, 585

- L**ABADIE-LAGRAVE, 616
- Labassère, sulphuretted hydrogen inhalations there, 254
- Lactic acid inhalations, 185; in croup, 185, 317; in diphtheria, 185, 281, 290, 292, 294, 317; in laryngitis, 295; in tracheitis, 235
- Laennec, 11, 20, 228, 345
- Lambert, 370
- Landeck, sulphuretted hydrogen inhalations there, 254
- Lange, G., 17, 369, 370, 375, 614, 616, 617, 618, 622, 628, 638, 648, 669, 691, 705, 711, 715
- Lange, J., 614, 616, 650, 661, 674, 679, 680, 686, 691, 705
- Langenbeck, 88, 94, 110
- Langenbrücken, sulphuretted hydrogen inhalations there, 254
- Langenhagen, 369
- Langlebert, 231
- Laryngeal abscess, inhalations in, 290
- Laryngeal affections, inhalations in, 284; *painful*, cherry laurel inhalations in, 137
- Laryngeal cancer, inhalations in, 193
- Laryngeal catarrh, *acute*, inhalations in, 284, 299, 340; alkaline mineral water inhaled in, 300; alkaline sul-



## LAR

phides inhaled in, 180; almond oil inhalations in, 340; althæa infusion inhaled in, 340; alum inhalations in, 285; carbolic acid inhalations in, 299, 300; carbonate of soda inhalations in, 285, 286; chloride of iron inhalations in, 157, 287; cold air inhalations in, 113, 285, 299, 340; cold water inhalations in, 118, 285, 299; *chronic*, inhalations in, 81, 235, 299; disinfecting inhalations in, 299; emollient inhalations in, 121, 299, 340; Ems water inhalations in, 235, 285, 299, 340; glycerine inhalations in, 340; gum arabic inhalations in, 340; iodide of potassium inhalations in, 287; iodine inhalations in, 287; mucilaginous inhalations in, 285; narcotic inhalations in, 285; nitrogen inhalations in, 248; opium inhalations in, 132; pneumatic treatment of, 686; sal ammoniac inhalations in, 174, 285, 286, 287, 299, 300; salt, common, inhalations in, 171, 285, 286, 287, 299, 300, 340; salts of lead inhalations in, 161, 285, 287, 299; salts of zinc inhalations in, 162, 285, 287, 299; silver, nitrate of, inhalations in, 160, 286, 287; solvent inhalations in, 299; stimulating alterative inhalations in, 191; sulphuretted hydrogen inhalations in, 254; sulphur waters inhalations in, 285; tannin inhalations in, 154, 285, 286, 287, 299, 300; tepid water inhalations in, 285; turpentine, oil of, inhalations in, 201

Laryngeal croup, *v.* Croup

Laryngeal diphtheria, inhalations in, 290; papayotine inhalations in, 188, 295; *v.* also Diphtheria

Laryngeal exudations, solvent inhalations in, 168

Laryngeal hæmorrhages, inhalations in, 259

Laryngeal hyperæmia, cold air inhalations in, 113

Laryngeal hyperæsthesia, conium inhalations in, 133

Laryngeal irritation, inhalations of potassium and sodium sulphides in, 180

Laryngeal mucous membrane, anæsthesia of, by means of inhalations, 308; hyperæsthesia of, hemlock inhalations in, 133

Laryngeal muscles, paralysis of, nerve-exciting inhalations in, 226; stimu-

## LAR

lating alterative inhalations in, 194. *V.* also Paresis of vocal cords

Laryngeal neuroses, inhalations (of arsenic), 233, 308

Laryngeal œdema, inhalations in, 289, 304

Laryngeal perichondrium, inflammation of, *v.* Perichondritis laryngea

Laryngeal phthisis, alkaline mineral waters inhaled in, 300, 306; alum inhalations in, 300, 303; berzoate of soda inhalations in, 212, 301, 305, 306; boric acid inhalations in, 302, 305; carbolic acid inhalations in, 215, 299, 300, 302, 303, 305, 306; carbonate of soda inhalations in, 306; chloride of iron inhalations in, 303; cold air inhalations in, 299, 303, 306; cold water inhalations in, 299, 306; copaiva balsam inhalations in, 302; creosote inhalations in, 302; disinfecting inhalations in, 299, 306; emollient inhalations in, 303; Ems water inhalations in, 299; eucalyptol inhalations in, 302; hyoseyamus inhalations in, 133; iodine inhalations in, 296; morphine inhalations in, 132; narcotic inhalations in, 303; opium inhalations in, 132; Peruvian balsam inhalations in, 302; pine shoot infusion inhaled in, 306; respirator, medicinal, to be employed in, 306; sal ammoniac inhalations in, 299, 300, 306; salicylic acid inhalations in, 302; salt, common, inhalations in, 299, 306; salts of lead inhalations in, 299, 303; salts of zinc inhalations in, 299, 303; silver, nitrate of, inhalations in, 302, 303, 307; solvent inhalations in, 167, 299, 306; sulphur waters inhalations in, 288; tannin inhalations in, 299, 300, 303; tar inhalations in, 198, 306; thymol inhalations in, 302; Tolu balsam inhalations in, 302; turpentine, oil of, inhalations in, 306

Laryngeal stenosis, penetration of foreign bodies into the trachea detected by tracheotomy in, 40; pneumatic treatment in, 527; syphilitic, mercury inhalations in, 232

Laryngeal syphilis, chlorate of potassium inhalations in, 177; inhalations in, 307; iodine inhalations in, 229; mercury inhalations in, 232, 308; opium inhalations in, 132; sulphur waters inhalation in, 248

## LAR

Laryngeal tuberculosis, inhalations in, 305. Cf. Laryngeal phthisis

Laryngeal ulcers, alum inhalations in, 303; antiseptic inhalations in, 296, 302; astringent inhalations in, 303; balsamic inhalations in, 243, 302; benzoate of soda inhalations in, 301; boracic acid inhalations in, 207, 258, 302; carbolic acid inhalations in, 215, 287, 302, 303; chlorate of potassium inhalations in, 177; chloride of iron inhalations in, 303; cold air inhalations in, 303; copaiva balsam inhalations in, 203, 302; creosote inhalations in, 288, 302; disinfecting inhalations in, 194, 296, 302; emollient inhalations in, 303; eucalyptol inhalations in, 302; hypomanganate of potassium inhalations in, 207; inhalations in, 287, 300; narcotic inhalations in, 303; nitrate of lead inhalations in, 288, 303; opium inhalations in, 132; Peruvian balsam inhalations in, 203, 302; salicylic acid inhalations in, 222, 288, 302; salt, common, inhalations in, 288, 289; silver, nitrate of, inhalations in, 159, 288, 302, 303; tannin inhalations in, 289, 303; thymol inhalations in, 288, 302; Tolu balsam inhalations in, 203, 302; solvent inhalations in, 167; stimulating alterative inhalations in, 192; sulphate of copper inhalations in, 162; sulphate of zinc inhalations in, 288, 303

Laryngitis, alum inhalations in, 156, 290, 296; ammonium bases in, 295; antiseptic inhalations in, 296; astringent inhalations in, 151, 289, 296; boracic acid inhalations in, 207, 296; carbolic acid inhalations in, 296; carbonate of potassium inhalations in, 176, 295; carbonate of soda inhalations in, 176, 289; cold air inhalations in, 113, 115; *croupous*. inhalations in, 295; emollient inhalations in, 121; Ems water inhalations in, 235; *granulosa*, 238; ice-water inhalations in, 289; inhalations in, 81, 289, 295; iodine inhalations in, 229; lactic acid inhalations in, 295; lime water inhalations in, 183, 295; lithium inhalations in, 295; mercurial inhalations in, 232; morphine inhalations in, 132; neurine inhalations in, 295; papayotine inhalations in, 295; *parenchymatosa*, 289 salicylic

## LIM

acid inhalations in, 222; silver, nitrate of, inhalations in, 290, 296; solvent inhalations in, 166, 295; sulphate of copper inhalations in, 162; sulphate of zinc inhalations in, 296; sulphur water inhalations in, 238; *syphilitica*, v. Laryngeal syphilis; tannin inhalations in, 290, 296; *ulcerosa*, v. Laryngeal ulcers

Laryngoscope, foreign bodies thereby detected in the respiratory organs, 38

Laryngotracheitis, Ems water inhalations in, 236; solvent inhalations in, 166

Larynx in expiration from condensed into rarer air, 714; inhalations with regard to, 24, 26, 103

Lassègue, 12

Lavoisier, 239

Lazarus, 617, 658, 661, 662

Lead, nitrate of, inhalations in laryngeal ulcers, 288, 303; in laryngeal catarrh, 299. V. also Salts of lead inhalations

Lead, oxalate of, inhalations of, 161

Lead colic, amyl nitrite inhalations in, 146

Lebert, 195, 324

Leconte, 247

Legallois, 249, 715, 716

Lehmann, 370

Leiblinger, 125, 133, 136, 162, 206

Leigh, 230

Lemaire, 213

Lender, 242

Lens, 247

Letzerich, 320

Leukæmia, oxygen inhalations in, 244

Levasseur, 326

Levinstein, 614, 615, 674, 705

Levis, 139

Lewes, 367

Lewin, 15, 21, 34, 38, 39, 41, 44, 63, 67, 69, 71, 85, 99, 105, 106, 119, 125, 132, 133, 136, 155, 156, 157, 159, 162, 163, 171, 173, 174, 177, 232, 233, 257, 260, 265, 269, 270, 271, 310, 313

Leyden, 22, 195, 214, 324, 325, 332, 618, 682

Lichtheim, 220

Liebreich, 185

Lime blossoms, inhalations of infusion of, in coryza, 263

Lime-water inhalations, 183; in bronchial catarrh, 317; in bronchial croup, 317; in bronchial diphtheria, 315; in bronchitis, 184, 315; in

## LIN

- bronchorrhœa, 184, 315; in croup, 183; in diphtheria, 183, 280, 290, 292, 294, 315; in laryngitis, 184, 295; in pharyngitis, 184; in phthisis, 184; in tracheitis, 295
- Lingen, 21
- Lippert, 613, 705
- Lippspringe, oxygen inhalations there, 247
- Liquor, ammonii caustici, inhalations of, v. Ammoniacal inhalations; anodynus Hoffmanni, inhalations of, 226; arsenicalis Pearsonii, inhalations of, 233, cf. Arsenic inhalations; ferri sesquichlorati, inhalations of, v. Chloride of iron inhalations
- Lithium carbonate inhalations, 176; in croup, 176, of the bronchi, 317; in diphtheria, 176, 290, 317; in laryngitis, 295; in tracheitis, 295
- Litten, 249
- Little, 204, 229
- Liver in compressed air, 664
- Lobethal, 20, 21
- Lobular pneumonia, caseous, inhalations in, 330; pneumatic treatment of, 700
- Löchner, 319
- Lombard, 35
- Lorday, 719, 721
- Lorenz, 370
- Lorray, 142
- Lortet, 615
- Losses of blood, oxygen inhalations after, 245
- Louis, 205
- Lovén, 324
- Löwe, 20, 30, 230
- Löwitt, 371
- Ludwig, 186
- Lüer, 63
- Lung, anæmia of; coal dust in, 30; deep respirations in, 579; echinococcus of, eucalyptol inhalations in, 224; entrance of dust into, 30, 34; foreign bodies having penetrated into, 40; in compressed air, 642, with regard to the elasticity of the tissue, 679; in diminution of air pressure on the surface of the thorax, 594; in expiration into rarefied air, 455, 458, 495, from denser, 712; inhalations with regard to, 103; in inspiration of compressed air, 441, 466; in thoracic compression, 609; melanotic infiltration of, 31; protoxide of iron drawn into, 34; sandstone dust

## LUN

- having penetrated into, 30; solid bodies inhaled into, 52
- Lung cavities, antiputrid inhalations in, 196; carbolic acid inhalations in, 215; pneumatic treatment of, 564; solvent inhalations in, 167
- Lungs, bleenorrhœa of, tar inhalations in, 198
- Lungs, capacity of (vital capacity), respiration with regard to, 578; expiration into rarefied air with regard to, 459; in compressed air, 645, 650; inspiration of compressed air with regard to, 445, with expiration into rarefied air, 513; in inspiration of rarefied air, 453; in prolonged expiration, 580; in rarefied air, 716
- Lungs, circulation, deficiency of blood in, pneumatic treatment of, 593; hyperæmia of, pneumatic treatment of, 566
- Lungs, cirrhosis of, compressed air inhaled in, 329
- Lungs, consumption of, acetate of lead inhalations in, 161; acetone inhalations in, 226; alkaline inhalations in, 344; athæa decoction inhalations in, 340, 341; alum inhalations in, 156, 336, 342, 343, 344, 356; antipyretic inhalations in, 351; antiseptic inhalations in, 197, 351; aromatic inhalations in, 343, 354; arsenic inhalations in, 333; astringent inhalations in, 393, 394; belladonna inhalations in, 343; benzoate of soda inhalations in, 212, 352, 354, 355, 357, 360, 362; benzol inhalations in, 208; benzole dioxide inhalations in, 221; bitter almond water inhalations in, 342; boracic acid inhalations in, 207, as prophylactic, 339; camphor inhalations in, 227; cannabis indica inhalations in, 135; carbolic acid inhalations in, 86, 215, as prophylactic, 339, 354, 357, 350, in compressed air, 519; carbonate of soda inhalations in, 341, 342; cherry laurel water inhalations in, 342; chloride of iron inhalations in, 157, as prophylactic, 335, 343, 358; chlorine inhalations in, 204; chloroform inhalations in, 344; cod-liver oil inhalations in, 88; cold air inhalations in, 115, as prophylactic, 336, 340, 341; cold water inhalations in, 119; copaiva balsam inhalations in, 354; creosote inhalations in, 209, 352, 354,

## LUN

360; disinfecting inhalations in, 197, as prophylactic, 338, 352; emollient inhalations in, 340, 344; Ems water inhalations in, 236, as prophylactic, 336, 341, 344; ether inhalations in, 140; ethereal oils in, 344; eucalyptol inhalations in, 224; glycerine inhalations in, 340, 344; gum arabic inhalations in, 340; hemlock extract inhalations in, 343; hyoscyamus inhalations in, 133, 343; inhalations in, 333; in compressed air, 519; inspiration, deep, in, 579; iodine inhalations in, 215, 228, 345, 349; juniper oil inhalations in, 343, 354; lime water inhalations in, 184; morphine inhalations in, 132, 342; narcotic inhalations in, 130, 342, 344; nitrogen inhalations in, 248, 250, 345, 350, 351; nitrous oxide inhalations in, 144; opium inhalations in, 132, 342; Peruvian balsam inhalations in, 354; pine oil inhalations in, 341, 343, 354; pneumatic treatment of, and of the diseases standing in connection with, 556, 695, counter-indications, 702; prophylactic treatment of threatening, 334; rarefied air with regard to, 730; respirator, medicated, to be worn in, 88, 89, 339; sal ammoniac inhalations in, 175, 342; salicylic inhalations in, 222, 352, 354, 360; salt, common, inhalations in, 172, as prophylactic, 336, 340, 342, 344; salvia, oil of, inhalations in, 343, 354; silver, nitrate of, inhalations in, 160; solvent inhalations in, 167; sulphate of copper inhalations in, 162; sulphate of zinc inhalations in, 356; sulphur water inhalations in, 238; sulphuretted hydrogen inhalations in, 253; sweet almond oil inhalations in, 340; tannin inhalations in, 154, as prophylactic, 336, 342, 343, 344, 356; tar inhalations in, 198, 200, 343, 354; thymol inhalations in, 352, 354; tincture of malate of iron inhaled in, as prophylactic, 336, 343; Tolu balsam inhalations in, 354; turpentine, oil of, inhalations in, 200, 201, 343, 352

Lungs, diseases of, inhalations in, 327

Lungs, emphysema of, alum inhalations in, 323; arsenic inhalations in, 234, 323; balsamic inhalations in, 204; belladonna inhalations in, 323; cade oil inhalations in, 323; carbolic acid

## LUN

inhalations in, 323, 543; carbonate of soda inhalations in, 323; cold air inhalations in, 115; *complicated by asthma*, pneumatic treatment of, 546; *complicated with bronchial catarrh*, pneumatic treatment of, 543; creosote inhalations in, 323; expiration into rarefied air with regard to, 456, 460, 537, 611, from compressed air, 714; hyoscyamus inhalations in, 323; inhalations in, 81, 322; juniper oil inhalations in, 323; mineral water inhalations in, 323; nitrogen inhalations in, 248; oxygen inhalations in, 243; pine oil inhalations in, 323, 543; pneumatic treatment of, 535, in the pneumatic chamber, 691; sal ammoniac inhalations in, 175, 323, 543; salt, common, inhalations in, 323; solvent inhalations in, 167; stramonium inhalations in, 323; sulphur water inhalations in, 238; sulphuretted hydrogen inhalations in, 254; tannin inhalations in, 323; tar water inhalations in, 323; thorax, compression of, in, 610, 611; turpentine, oil of, inhalations in, 323, 543; vicarious, pneumatic treatment of, 544

Lungs, gangrene of, acetate of lead inhalations in, 161; antiseptic inhalations in, 193, 196, 300; benzoate of soda inhalations in, 332; benzoic acid inhalations in, 212; benzole dioxide inhalations in, 221; bromine inhalations in, 332; cade oil inhalations in, 332; carbolic acid inhalations in, 214, 332; chloride of iron inhalations in, 157; chlorine inhalations in, 206, 300; creosote inhalations in, 332; disinfecting inhalations in, 196, 300; hypermanganate of potassium inhalations in, 207, 332; inhalations in, 330; oxygen inhalations in, 332; pine oil inhalations in, 332; pine shoot infusion inhaled in, 332; respirator, medicated, used in, 333; salicylic acid inhalations in, 332; stimulating alterative inhalations in, 193, 196; sulphate of copper inhalations in, 162; tannin inhalations in, 155, 333; tar inhalations in, 200; thymol inhalations in, 332; turpentine, oil of, inhalations in, 201, 331

Lungs, hæmorrhage from, v. Hæmoptysis

Lungs, hyperæmia of, cold air inhala-

## LUN

- tions in, 113; pneumatic treatment of, 573
- Lungs, infiltration of, inflammatory, pneumatic treatment of, 561; inhalations in, 344; melanotic, 31; nitrogen inhalations in, 251
- Lungs, inflammation of, alkaline inhalations in, 344; alum inhalations in, 344; benzole dioxide inhalations in, 221; carbolic acid inhalations in, 215, 330; *caseous*, inhalations in, 330, pneumatic treatment of, 700; chloroform inhalations in, 140, 328, 344; cold air inhalations in, 113; *desquamative*, v. Desquamative pneumonia; diminution of air pressure on the thoracic surface in, 602; emollient inhalations in, 344; Ems water inhalations in, 344; ether inhalations in, 141; ethereal oils inhaled in, 344; glycerine inhalations in, 344; inhalations in, 327, 343; *interstitial*, 329; iodine inhalations in, 345; narcotic inhalations in, 129, 344; nitrogen inhalations in, 256, 344; pneumatic treatment of, 329, 698; salt, common, inhalations in, 344; solvent inhalations in, 167; tannin inhalations in, 344; tar inhalations in, 199; turpentine, oil of, inhalations in, 330
- Lungs, mycosis of, v. Pneumo-mycosis
- Lungs, tuberculosis of, respiratory treatment of, 361. Cf Consumption of lungs
- Lungs, ventilation of, in deep inspiration, 578; in expiration into rarefied air, 497; in inspiration of compressed air, 447; in inspiration of rarefied air, 452; in prolonged expiration, 580; respiration with regard to, 578
- Lymph, losses of, oxygen inhalations in, 245
- Lymphatics in compressed air, 666

## MACKENZIE, 21

- Maddock, 20, 87, 136, 140, 206
- Mader, 17, 367
- Magendie, 12
- Mal de montagne, rarefaction of air in connection with, 725
- Mallow decoction, inhalations of, 125, in angina phlegmonosa, 272
- Manassein, 213
- Mandl, 84, 86, 124
- Marc, 247, 616
- Marcellus Empiricus, 27
- Mareet, 617, 716

## MIN

- Marey, 656
- Mariotte, 8
- Marsh mallow root, v. Althæa root
- Mascagni, 9
- Masius, 616
- Masks of the pneumatic apparatus, 438. V. supra, Inhalatory masks
- Massei, 370
- Matthieu, 44, 64, 67, 73, 78, 79, 117, 258, 261
- Mauthner, 186
- Mayr, 329, 369, 373, 735, 417, 433, 436
- Medicinal 'Köcher' in Biedert's apparatus, 412
- Medicinal substances, addition of vapours of, to compressed air, 519, 532, 534; inhalations of, and their effects, 49, 109
- Meinberg, carbonic acid inhalations there, 252
- Meissner, 20
- Melancholia, nitrous oxide inhalations in, 145
- Melanotic infiltration of the lungs in miners, 31
- Menstrual discharge in compressed air, 664; pneumatic treatment of disturbances of, 573
- Mérat, 247
- Mercurial cigarettes, 231
- Mercury chloride, inhalation of, 231; in herpetic affections, 232; in laryngeal syphilis, 231, 232, 308; in oral ulcers, 283; in ozæna syphilit., 231; in parenchymatous laryngitis, 232; in parenchymatous pharyngitis, 232; in pharyngeal syphilis, 232, 284; in pharyngeal ulcers, 283; in syphilis of the oral cavity, 283
- Merkel, 20, 22, 134
- Mesoarytenoiditis, astringent inhalations in, 151
- Metadioxybenzol, inhalations of, 217
- Meteorism, air pressure in the pneumatic chamber with regard to, 631
- Methyl bichloride, inhalations of, in asthma, 326
- Metzeler, 72
- Meyer, 63, 137
- Michaelis, 616
- Michel, 21, 271
- Michelson, 213
- Milk, vapour of, inhalations, 124; in angina phlegmonosa, 272; in coryza, 263
- Milliet, 13, 613, 705, 708
- Milne-Edwards, 208
- Mineral water inhalations, 234; in

## MIN

angina tonsil., 238; in aphonia, 238; in asthma, 238; in bronchial catarrh, 235; in bronchitis, 235, 238; in bronchorrhœa, 236; in cardiac affections, 238; in laryngeal catarrh, 235, 300; in laryngeal phthisis, 238, 306; in laryngeal syphilis, 238 in laryngitis, 235, 238; in pharyngeal catarrh, 236, 271; in pharyngeal syphilis, 238; in pharyngitis granulosa, 236, 238; in pharyngitis sicca, 256; in pulmonary emphysema, 238, 323; in pulmonary phthisis, 236, 238; in spasmus glottidis, 238; in tracheal catarrh, 236; in tracheitis, 235. V. also Aix-la-Chapelle. Amélie-les-Bains, Baden (near Vienna), Bagnères de Luchon, Bilin, Causerets, Eaux-Bonnes, Eilsen, Ems, Euzettes-Bains, Fachingen, Franzenbad, Inselbad, Ischl, Kissingen, Kronthal, Labassère, Landeck, Langenbrücken, Lippspringe, Meinberg, Nenndorf, Neuenahr, Obersatzbrunn, Pierrefonds, Rehme, Reichenhall, Schinzach, Selters, Soden, Vervet, Vichy, Weilbach

Miners, pneumomelanosis in, 31  
Minqer, 134  
Miquet, 209  
Mists, v. Water mist  
Mists, penetration of, into the respiratory organs, 46  
Mistura oleosa-balsamica, inhalations of, 204  
Mitral orifice, stenosis of, pneumatic treatment in, 567; Valsalva's experiment in, 584  
Mitral valve, insufficiency of, pneumatic treatment in, 567; Valsalva's experiment in, 584  
Moist heat, inhalations of, 124. Cf. Warm water inhalations  
Moistness of compressed air, 636, 637  
Mordhorst, 371  
Moritz, 22  
Morphine inhalations, 132; in bronchial catarrh, 311, 342; in bronchitis, 132; in laryngeal phthisis, 132; in laryngitis, 132; in oral and pharyngeal ulcers, 283; in pulmonary phthisis, 342  
Morton, 140, 204  
Mosler, 22, 224  
Mosso, 371  
Moura Bonrouillou, 15, 20, 39, 42, 45  
Mouth, bad smell of, hypermanganate of potassium in, 207

## NEP

Mouth, diseases of, inhalations in, 102, 266  
Mouth, hæmorrhages of, inhalations in, 256  
Mouth, inflammation of, apthous, chlorate of potassium inhalations in, 177; cold air inhalations in, 115; cold water inhalations in, 117; emollient inhalations in, 121; inhalations in, 81  
Mouth, inhalations with regard to, 24, 26  
Mouth, syphilis of, inhalations in, 283; iodine inhalations in, 229; mercury chloride inhalations in, 232  
Mouth, ulcers of, respiratory treatment in, 282  
Mouth fluid in inhalations, 101  
Mouthpiece of pneumatic apparatus, 438  
Mucilaginous inhalations, in laryngeal catarrh, 285; in pharyngeal catarrh, 269; in whooping cough, 319  
Mudge, 85, 124, 312, 331  
Mühry, 134  
Müller, 583, 615  
Müller's experiment, 488, 489, 490, 491, 492, 493, 584  
Murray, 11, 229  
Muscular convulsions in thoracic compression, 610  
Muscular force in compressed air, 679; in rarefied air, 726  
Musk, inhalation of, 79  
Mycosis of the air passages, benzole dioxide inhalations in, 221, carbolic acid inhalations in, 215; of the lung, v. Pneumomycosis

**N**ARCOSIS, caustic ammonia inhalations in, 226. Cf. Anæsthesia  
Narcotic fumigations, 131  
Narcotic inhalations, 93, 125; anæsthesia by means of, 130; in asthma, 129; in convulsive cough, 129; in desquamative pneumonia, 344; in inflammation of the lungs, 129; in irritative cough, 129; in laryngeal catarrh, 285; in laryngeal ulcers, 303; in pleuritis, 129; in pulmonary phthisis, 130, 342, 344; in whooping cough, 129, 319  
Nasal catarrh, v. Coryza  
Natanson, 66  
Naunyn, 208  
Nega, 133  
Nephogène, 65

## NER

Nerve-exciting inhalations, 93, 225  
 Nervous exhaustion, nitrous oxide inhalations in, 144  
 Nervous system in compressed air, 642  
 Nervous weakness, nitrous oxide inhalations in, 144  
 Neuenahr, inhalations of the mineral waters there in emphysema, 323  
 Neukomm, 617, 619  
 Neumann, 19, 710  
 Neundorf, inhalations of the mineral waters there, 238, 254  
 Neurasthenia, nitrous oxide inhalations in, 144  
 Neurine inhalations, 185; in bronchial croup, 317; in diphtheria, 186, 317; in laryngeal diphtheria, 294; in laryngitis, croupous, 295; in tracheitis, 295  
 Nevin, 231  
 Newborn infants, crying of, 581  
 New formations, caustic inhalations in, 152  
 Niedermeyer, 63, 99  
 Niemeier, 12, 23, 94, 96, 97, 98, 159, 160, 316, 319, 371, 583  
 Nitre inhalations, 177; in asthma, 178, 325  
 Nitre paper, 135, 179, 325  
 Nitrogen excretion, v. Urea, excretion of  
 Nitrogen gas, development of, in the blood on the withdrawal of stronger air pressure, 682  
 Nitrogen, increase of, in compressed air, 518  
 Nitrogen inhalations, 247; at Inselbad, 248; at Lippspringe, 247; in asthma, 251; in bronchial catarrh, 248, 250; in broncho-pneumonia, 350; in broncho-pneumonic ulcerations, 351; in catarrh of the apex, 250; in catarrhs, 250; in desquamative pneumonia, 345; in emphysema, 248; in infiltration of the lungs, 251; in inflammation of the lungs, 251; in laryngeal catarrh, 248; in peribronchitis, 350; in pulmonary phthisis, 248, 251, 345, 350, 351  
 Nitrous oxide, anaesthesia by means of, 130, 143; inhalations of, 142, in angina pectoris, aortic aneurism, asthma, delirium tremens, headache, hysteria, insomnia, melancholia, nervous debility, nervous exhaustion, neurasthenia, pulmonary consumption, spinal irritation, 144; in-

## OPI

haled in combination with oxygen, 144  
 Noll, 319  
 Nostrils, diseases of, inhalations in, 263  
 Nostrils, hæmorrhages from, inhalations in, 256  
 Nothnagel, 242  
 Nunneley, 208  
 Nutrition, inhalations with regard to, 100  
 Nutrition in compressed air, 673; of the lungs, deep inspirations in, disturbances of, 578  
 Nysten, 247

**O**AK bark, decoction of, vapours of, added to compressed air, 486  
 Oak tan, infusion of, used for inhalations, 155  
 Obersalzbrunn, inhalations of mineral waters at, 323  
 Obesity, pneumatic treatment, 631, 633, 707  
 Occlusion of the respiratory organs, pneumatic treatment in, 526  
 Oertel, 22, 23, 72  
 Oil emulsions, inhalations of, 125; in chronic pharyngeal catarrh, 269; in oral and pharyngeal ulcers, 283  
 Oleire, 254  
 Oleum amygdalarum dulc., inhalations of, v. Sweet almond oil inhalations; animale æthereum, inhalations of, 227; cadinum, inhalations of, v. Cade oil inhalations; eucalypti, inhalations of, v. Eucalyptol inhalations; juniperi, inhalations of, v. Juniper oil inhalations; olivarum, v. Olive oil; papaveris, inhalations of, 125; pini pumilionis, inhalations of; pini silvestris, inhalations of, v. Pine oil inhalations; salviæ, v. Salvia oil; terebinthinæ, inhalations of, v. Turpentine, oil of, inhalations  
 Olive oil, inhalations of, 125  
 Olliver, 88  
 Opium inhalations, 131; combined with sulphate of zinc, 162; in asthma, 325; in bronchial catarrh, 132, 311, 342; in convulsive cough, 132; in irritative cough, 132; in laryngeal catarrh, 132; in pharyngeal catarrh, 267; in pharyngeal ulcers, 267; in pulmonary consumption, 132, 342; in syphilis of the respiratory mucous

- OST
- membrane, 132; in tuberculosis of the respiratory mucous membrane, 132; in ulcers of the oral cavity, 283; in ulcers of the respiratory mucous membrane, 132; in whooping cough, 319
- Ostium venosum dextrum, pneumatic treatment in stenosis of, 574; sinistrum, stenosis of, pneumatic treatment in, 570, Valsalva's experiment in, 585
- Otalgia, amyl nitrite inhalations in, 147
- Otilienquelle, v. Inselbad
- Oxidation in compressed air, 671
- Oxygen, absorption of, into the blood in respiration in compressed air, 245, (id.) 670, in rarefied air, 716, v. also Exchange of gases; combined with nitrous oxide inhalations, 144; increase of, in compressed air, 518; ozonised inhalations of, 241, 246
- Oxygen inhalations, 258; after losses of lymph, 245; in anaemia, 244; in apnoea, 244; in asphyxia, 243; in asthma, 244; in caries, 245; in catarrhs of the respiratory organs, 243; in chloroform poisoning, 244; in chlorosis, 244; in convalescent cases, 245; in croup, 243; in emphysema, 243; in gangrene, 245; in gas poisonings, 244; in gout, 244; in leukæmia, 244; in loss of blood, 245; in pulmonary gangrene, 332; in ulcers, 245; in uric acid diathesis, 244
- Ozæna, alum inhalations in, 156; carbolic acid inhalations in, 214; carbonate of soda inhalations in, 176; mercury inhalations in, 231
- Ozonised oxygen, inhalations of, 241, 246
- PADERBORN, v. Inselbad
- Pagenstecher, 12
- Pantheil, 252
- Pannu, 16, 614, 643, 648, 650, 654, 660, 661, 662, 666, 669
- 'Panzer,' pneumatic, 590, 591
- Papayotine inhalations, 187; in bronchial croup, 317; in bronchial, laryngeal, and tracheal diphtheria, 188, 295, 317; in laryngitis croupous, 295; in tracheitis, 295
- Paradioxybenzol, inhalations of, 217
- Parenchymatous inflammations, emollient inhalations in, 121
- Paresis of the vocal cords, v. Vocal cords, paresis of
- PHA
- Particles of stone in the respiratory organs, 30
- Pascal, 9
- Pastils employed in asthma, 326; with benzoic acid, 210; with iodine, 230; with mercury, 231
- Peacock, 35
- Pearson, 140
- Peribronchitis, nitrogen inhalations in, 350; pneumatic treatment of, 561, in the pneumatic chamber, 697; solvent inhalations in, 107
- Perichondritis laryngea, antiseptic inhalations in, 304; benzoate of soda inhalations in, 305; boracic acid inhalations in, 305; carbolic acid inhalations in, 304; disinfecting inhalations in, 304; inhalations in, 289, 304
- Perturbatory symptoms, 646, 682
- Peruvian balsam inhalations, 93, 203; in bronchorrhœa, 312; in bronchopneumonic ulcerations, 354; in laryngeal ulcers, 203, 302; in paresis of the vocal cords, 308; in pharyngeal catarrh, 88; in phthisis, 354; in tracheal catarrh, 88; in tracheal ulcers, 203
- Petrenz, 19, 31
- Petrequin, 654
- Pfeifer, 662
- Pflüger, 239, 241
- Pharyngeal and laryngeal diphtheria, treatment of, 291. V. also Diphtheria
- Pharyngeal catarrh, alkaline mineral waters inhaled in, 271; alum inhalations in, 267, 268, 269; astringent inhalations in, 151, 269; bitter almond water inhalations in, 270; carbonate of potassium inhalations in, 269; carbonate of soda inhalations in, 268, 271; chloride of iron inhalations in, 157, 270; cold air inhalations in, 266; cold water inhalations in, 117; copaiva balsam inhalations in, 88; dry, v. Pharyngitis sicca; emollient inhalations in, 267, 269; Ems water inhalations in, 236, 267, 269, 270; *follicular*, inhalations in, 271; glycerine inhalations in, 269; *granular*, inhalations in, 81, 267, 271; ice water inhalations in, 267; iodide of potassium inhalations in, 269; mucilaginous decoctions in, 269; oil emulsion inhalations in, 269; Peruvian balsam inhalations in, 88; respirator, medic., in, 89; sal ammoniac inhalations in, 174,



## PHA

- 268, 269, 271; salt, common, inhalations in, 171, 267, 268, 269, 270, 271; silver, nitrate of, inhalations in, 158, 267, 268, 269, 272; solvent inhalations in, 268, 269; stimulating alterative inhalations in, 191; sulphate of zinc inhalations in, 162; sulphur waters inhalations in, 271; sulphuretted hydrogen inhalations in, 254; tannin inhalations in, 154, 267, 268; tepid water inhalations in, 267; tincture of iodine inhalations in, 269
- Pharyngeal cavity, diseases of, 266
- Pharyngeal hæmorrhages, alum, cold water, ice water, tannin inhalations in, 258
- Pharyngeal mucous membrane, anæsthesia of, by inhalations, 308
- Pharyngeal syphilis, alum inhalations in, 284; carbonate of soda inhalations in, 284; chlorate of potassium inhalations in, 177; iodide of potassium inhalations in, 284; iodine inhalations in, 229; mercury inhalations in, 232, 284; sal ammoniac inhalations in, 284; salt, common, inhalations in, 284; silver, nitrate of, inhalations in, 284; sulphur waters inhalations in, 238; tannin inhalations in, 284
- Pharyngeal ulcers, antiseptic treatment in, 194; boracic acid inhalations in, 283; carbolic acid inhalations in, 283; chlorate of potassium inhalations in, 177; disinfecting inhalations in, 194, 283; glycerine inhalations in, 283; gum inhalations in, 283; hypermanganate of potassium in, 207; iodine inhalations in, 283; morphine inhalations in, 283; oil emulsion inhalations in, 283; opium inhalations in, 283; silver, nitrate of, inhalations in, 159, 283; sublimate inhalations in, 283
- Pharyngitis, alum inhalations in, 156; astringent inhalations in, 151; camomile infusion inhalations in, 272; carbolic acid inhalations in, 273; carbonate of potassium inhalations in, 175; carbonate of soda inhalations in, 175, 272; carbonic acid inhalations in, 252; *catarrhal*, v. Pharyngeal catarrh; cold air inhalations in, 81, 144; cold water inhalations in, 117; emollient inhalations in, 121; Ems water inhalations in, 235; *granulosa*, inhalations in, 81, 175, 229, 236, 238, 252; *hyp-*

## PLE

- plastica*, inhalations in, 272; ice water inhalations in, 272; iodine inhalations in, 229; lime water inhalations in, 184; marsh mallow (*althea*) decoction inhalations in, 272; mercury inhalations in, 232; milk, vapour of, inhalations in, 272; *phlegmonosa*, inhalations in, 272, 273; sal ammoniac inhalations in, 166, 273; salicylic acid inhalations in, 273; *salvia* decoction inhalations in, 272; *sambucus* decoction inhalations in, 272; salt, common, inhalations in, 166, 171, 272; *sicca*, inhalations in, 117, 166, 171, 175, 236, 269; silver, nitrate of, inhalations in, 159; solvent inhalations in, 166; sulphur waters inhalations in, 238; tannin inhalations in, 155; *varicosa*, inhalations in, 270; warm water inhalations in, 272
- Pharynx, inhalations with regard to, 24, 27
- Phenol, inhalations of, v. Carbolic acid inhalations
- Phlegmonous inflammations, emollient inhalations in, 121
- Phthical habit, pneumatic treatment in, 556, deep inspirations in, 579, in the pneumatic chamber, 696
- Phthisis laryngea, v. Laryngeal phthisis; pulmonum, v. Pulmonary phthisis
- Pick, 145
- Pierrefonds, inhalations of the mineral waters of, 238, 254
- Pietra Santa, 15, 20, 615
- Pilocarpin in diphtheria, 280
- Pine cone decoction, vapours of, added to compressed air, 519
- Pine oil inhalations, 93, 202; in apex catarrh, 341; in bronchial catarrh, 343, in compressed air, 532, (id.) 534, 543; in broncho-pneumonic ulcerations, 354; in emphysema, 323, 543; in paresis of the vocal cords, 308; in pulmonary gangrene, 332; in pulmonary phthisis, 343, 354
- Pine shoots, inhalations of infusion of, 202, in laryngeal tuberculosis, 306, in pulmonary gangrene, 332
- Piner, 23
- Piorry, 12, 229, 230
- Pireher, 617, 711, 713, 714
- Pix liquida, inhalations of, v. Tar inhalations
- Pleuritic exudation, compression of thorax in, 611; diminution of air pressure on the thoracic surface in,

## PLE

- 603; pneumatic treatment in the chamber employed in, 703  
 Pleuritis, narcotic inhalations in, 129; pneumatic treatment in, 526, 551  
 Pleuropneumonia, cold air inhalations in, 113; change of air pressure on the thoracic surface in, 602  
 Plinius, 8, 19, 200  
 Plugge, 313  
 Plumbum aceticum, nitricum, oxalicum, inhalations of, 160, 161. Cf. Acetate of lead inhalations, Lead, nitrate of, inhalations  
 Pneumatic apparatus, 375, 376; Biedert's, 410, 437; Cube's, 388; Finkler's, 407; Fränkel's, 416; Geigel's, 417, 433, 437, 439, 543, 545, 546, 549; Hauke's, 376, 589, 590; Kochs's, 407; Lange's, 618, 622; V. Liebig's, 624, 638; Mayr's, v. Geigel's pneumatic apparatus; Schnitzler, 394, 437; Simonoff's, 629; Störk's, 379; Tabarié's, 619; Tobold's, 392; Waldenburg's, 380, 437; Weil's, 393  
 Pneumatic chamber, 612, 618, 630, 709; air in, 635; expiration into rarer air from, 711; with rarefied air, 715. V. also Compressed air, Pneumatic treatment, Rarefied air  
 Pneumatic 'Panzer,' 584, 590  
 Pneumatic treatment, 367; compulsory, 587; counter-indications, 523, 683, 702, 729; excretion of urine in, 555; in affections of the circulatory organs, 565; in anæmia, 708; in anæmia of the pulmonary circulation, 573; in apex catarrh, 541, 560, 561, 697; in asphyxia, 526, 601, 631; in asthma, 327, 528, 546, 547, 694; in atelectasis, congenital, 601; in auditory affections, 633; in bronchial catarrh, 528, 529, 533, 534, 686, 688; in bronchiectasis, 610; in children, 588; in chlorosis, 573, 708; in constrictions, 631; in croup, 523, 605; in desquamative pneumonia, 543, 562, 698; indications for, 521, 522, 683, 727; in diphtheria, 528; in emphysema, 460, 535, 537, 611, 691, 714; in empyema, 551, 554; in fatty heart, 572; in hæmoptysis, 572, 701; in hyperæmia of the lungs caused by engorgement, 572; in hyperæmia of the pulmonary circulation, 566; in infiltration of the lungs, inflammatory, 561; in inflammation of the lungs, 327, 562, 602,

## PRA

- 698, 700; in inflammations of the respiratory mucous membrane, 685, 687; in insufficiency and stenosis of the aortic valve, 570; in insufficiency and stenosis of the mitral valve, 567; in insufficiency and stenosis of the tricuspidal valve, 574; in laryngeal catarrh, 686; in laryngeal stenosis, 527; in menstrual disturbances, 573; in meteorism, 631; in obesity, 631, 633, 707; in obstruction of the air passages, 526; in paralytic thorax, 524; in peribronchitis, 561, 697; in phthisical habit, 556, 558, 696; in pleuritis and pleuritic exudation, 526, 551, 552, 553, 603, 611, 703; in pleuro-pneumonia, 602; in pulmonary cavities, 564; in pulmonary consumption and the diseases in connection with it, 556, 695, 702; in respiratory insufficiency, 524; in rachitis, 696; in suppression of hæmorrhoidal flux, 573; in tracheal stenosis, 527; in ulcerative, broncho-pneumonia, 350, 562, 700; in whooping cough, 708; thoracocentesis and thoracic fistula with regard to, 553, 604. Cf. Compressed air, Expiration into compressed air, Expiration into rarefied air, Inspiration of compressed air, Inspiration of rarefied air, Pneumatic apparatus, Pneumatic chamber, Rarefied air  
 Pneumatic 'Wanne,' 588, 589, 590  
 Pneumomelanosis in miners, 31  
 Pneumomycosis, carbolic acid inhalations in, 215, 360; creosote, benzoate of soda, salicylic acid, tar inhalations in, 360; disinfecting inhalations in, 197  
 Pneumonia, v. Lungs, inflammation of; desquamative, v. Desquamative pneumonia  
 Poggiale, 15, 38, 79  
 Poiseuille, 656  
 Pol, 13, 613, 664, 665, 669, 680, 681, 683, 707  
 Polansky, 155, 156  
 Pollak, 135, 231  
 Poppy oil, inhalations of, 125  
 Position in deep inspiration, 578; in inhalations, 101; in pneumatic treatment, 440; in prolonged expiration, 582  
 Poyser, 613  
 Practical application of the pneumatic method, 436  
 Pramberger, 371

## PRA

- Pravaz, 13, 612, 613, 614, 617, 654, 662, 680, 687, 691, 701, 705, 708
- Pressure in aortic system, in expiration into compressed air, 481; in inspiration of rarefied air, 488; of the blood, v. Blood pressure
- Priestley, 10, 19, 238, 242
- Frussic acid inhalations, 136
- Pseudomembranous inflammations, emollient inhalations in, 122
- Pujade, 12
- Pulmonaria, inhalations of decoctions of, 125
- Pulse, in compressed air, 655; in expiration into compressed air, 481, 484; in expiration into rarefied air, 498, 571; in inspiration of compressed air, 463, 468, 477; in inspiration of rarefied air, 487, 491; in insufficiency and stenosis of the mitral valve in pneumatic treatment, 567; in Müller's experiment, 489; in rarefied air, 719; in Valsalva's experiment, 481
- Pulsuhr, 477, 488, 502
- Pulvérisateur des liquides médicamenteux, 61
- Pulvérisation des liquides médicamenteux, 15
- Pulverisation of medicinal fluids for purposes of inhalation, 61, 67, 71
- Pulverising apparatus, v. Inhalatory apparatus
- Pundschu, 615
- Pusch, 173
- Pyrocatechin, inhalation of, 217

## QUINCKE, 662

Quinine inhalations in whooping cough, 302

**R**ACHITIS, change of air pressure on the surface of the thorax in, 606

Ramazzin, i, 19, 30, 35

Rarefied air, 710, 729; arterial tension in, 720; blood pressure in, 720; body temperature in, 721; body weight in, 725; brain in, 725; carbonic acid excretion in, 716; circulation in, 718; counter-indications against the therapeutic use of, 729; exchange of gases in the lungs in, 715; excretion of urea in, 722; expiration into, v. Expiration into rarefied air; expiration in, 715; general health in, 725; indications for therapeutic use of, 727; infective

## RES

- diseases with regard to, 731; inspiration in, 714; inspiration of, v. Inspiration of rarefied air; intestinal gases in, 716; in the pneumatic chamber, 715; muscular force in, 726; nitrogen excretion in, 722; oxygen absorption in, 716; pulmonary phthisis with regard to, 731; pulse in, 719; respiration in, 715; serofulosis with regard to, 731; spinal cord in, 725; therapeutic use of, v. Expiration into rarefied air, Inspiration of rarefied air, Pneumatic treatment; tissue exchange in, 722; vital capacity in, 716
- Raspail, 227
- Rayer, 182
- Rayl, 204
- Reading aloud as respiratory exercise, 583
- Regnal, 208
- Regnault, 239
- Rehme, inhalations of mineral waters of, 237
- Reichenhall, inhalations of the mineral water of, 237, in emphysema, 323, pneumatic chamber at, 624
- Reiset, 239
- Reissacher, 721
- Resorcin, inhalations of, 217
- Respiration, in climbing, 585; in compressed air, 647; in inhalations, 108; in inspiration of compressed air, 441, with expiration into rarefied air, 511; in inspiration of rarefied air, 451; in rarefied air, 717; in walking, 585. V. also Expiration, Inspiration
- Respirator, benzol inhalations with, 209; carbolic acid inhalations with, 88, 217; cold air inhalations by means of, 95, 115; creosote inhalations by means of, 210; Curschmann's, 88; Feldbausch's, 91; Hausmann's, 90; in bronchial catarrh, 88; in bronchiectasis, 316; in bronchitis putrida, 88, 313; in bronchorrhœa, 88, 313; in convulsive cough, 88; in febris nervosa stupida, 88; in hæmoptysis, 88; in laryngeal tuberculosis, 306; in pharyngeal catarrh, 88; in pulmonary gangrene, 332; in pulmonary phthisis, 87, 88, 339; in tracheal catarrh, 88; in whooping cough, 88; Langenbeck's, 88; medicated, for permanent inhalation, 87; Olliver's, 88; pyrocatechin inhaled with, 221; Sales-Girons', 87; Sigg's, 88; tar inhala-

## RES

tions by means of, 199; thymol inhalations by means of, 223; to be worn in infective diseases, 92; turpentine, oil of, inhalations by means of, 202

Respiratory insufficiency, cold air inhalations in, 115; pneumatic treatment of, 524

Respiratory movements in compressed air, 647

Respiratory organs, absorption of inhaled bodies in, 52, 55, 104; accustoming of, to irritations, 28; acetate of lead inhalations in, 160; alum inhalations in, 156; ammoniated inhalations in, 181; aqueous vapours in inhalations with regard to, 57; aqueous vapours penetrating into, 47; astrincent inhalations in, 147; benzoic acid inhalations in, 210; *blemnorrhœa* of, stimulant alterative inhalations in, 191; blood-vessels of, in astrincent inhalations, 149, in cold air inhalations, 110, in inspiration of compressed, with expiration into rarefied air, 503; carbonate of potassium inhalations in, 175; carbonate of soda inhalations in, 175; carbonic acid inhalations in, 252; caustic inhalations in, 147; coal dust in, 30; cold air inhalations in, 109; cold of inhaled fluids with regard to, 58; cold water inhalations in, 116; corrosive ulcers of, inhalations in, 356; dust penetrating into, 30; emollient inhalations in, 119; ether and ethereal oils, their penetration into, 47; fluid bodies, their penetration into, 25; foreign bodies, their penetration into, 29; gases, their penetration into, 25, 29, 46; hyperæmia of, cold air inhalations in, 113; hyperæsthesia of the mucous membrane of, hemlock inhalations in, 133; in compressed air, 642; inflammations of, cold air inhalations in, 113, pneumatic treatment of, 685, (id.) 687; mists, their penetration into, 46; nerve-exciting inhalations in, 225; nitrate of potassium inhalations in, 177; nitrate of soda inhalations in, 177; nitrogen inhalations in, 249; occlusion of, pneumatic treatment in, 526; oxygen inhalations in, 242; painful affections of, inhalations of cherry laurel water in, 137; pulverised fluids penetrating into, 25, 29, 35, 79; sal ammoniac inhalations in, 174; salicylic acid

## RHA

inhalations in, 221; salt, common, inhalations in, 171; sandstone dust in, 30; sensitiveness of, towards penetrating bodies, 25, 28; silver, nitrate of, inhalations in, 158; solid bodies, their penetration into, 25, 29; solvent inhalations in, 163; stimulating alterative inhalations in, 188; styptic inhalations in, 147; sulphate of copper inhalations in, 162; sulphate of zinc inhalations in, 161; sulphide of potassium inhalations in, 180; sulphide of sodium inhalations in, 180; sulphuretted hydrogen inhalations in, 253; tannin inhalations in, 153; tar inhalations in, 198; temperature of inhaled fluids with regard to, 57; turpentine, oil of, inhalations in, 202; vapours, their penetration into, 25, 29, 46; warmth of inhaled fluids with regard to, 58

Respiratory organs, catarrhs of, ammoniated inhalations in, 182; anised oil inhalations in, 88; astrincent inhalations in, 150; bromide of potassium inhalations in, 138; camomile flowers infusion inhaled in, 88; carbonate of potassium inhalations in, 176; carbonate of soda inhalations in, 176; cold air inhalations in, 113; cold water inhalations in, 117; elder blossoms infusion inhaled in, 88; emollient inhalations in, 121; inhalations in, 82; nitrogen inhalations in, 250; oxygen inhalations in, 243; respirator, medicated, in, 88; stimulating alterative inhalations in, 191; sulphides of potassium and sodium inhalations in, 180; sulphuretted hydrogen inhalations in, 254; tannic acid inhalations in, 154. V. also Bronchial catarrh, Coryza, Laryngeal catarrh, Tracheal catarrh

Respiratory organs, hæmorrhages of, acetate of lead inhalations in, 161; alum inhalations in, 156, 358; chloride of iron inhalations in, 157, 358; cold air inhalations in, 111, 116; cold water inhalations in, 119; inhalations in, 81, 255, 357; styptic inhalations in, 151; sulphate of iron inhalations in, 163; sulphate of zinc inhalations in, 162; tannic acid inhalations in, 155

Respiratory regimen, 87

Rhatany, preparations of, used for inhalations, 155

Rhazes, 8, 233

## RHI

Rhinitis catarrhalis, v. Coryza  
 Rhufuss, 248  
 Richardson, 67, 294  
 Richter, 159  
 Riegel, 17, 195, 364, 469, 470, 473, 476,  
 478, 481, 486, 489, 492, 498, 504  
 Rohden, 17, 367  
 Rohn, 319  
 Rokitansky, 22, 211, 301, 355, 357, 362,  
 363, 364  
 Rosenbach, 213  
 Rosenfeld, 370  
 Rosenthal, 21, 34  
 Rossbach, 147, 161, 186, 187, 188, 295,  
 371, 581, 618  
 Rothe, 22, 213, 214  
 Roumier, 210  
 Roy, 20  
 Runge, 615  
 Ruppert, 22, 34, 53, 55  
 Ruscum oil, inhalation of, 93  
 Rush, 198

## SAKOWSKY, 213

Sal ammoniac inhalations, 172; in  
 angina phlegmonosa, 273; in asthma,  
 175, 519; in bronchial catarrh, 174,  
 310, 342, 519, 552, 534, 544; in  
 bronchitis in compressed air, 519;  
 in catarrhs, acute, 174; in coryza,  
 264, 265; in emphysema, 175, 323,  
 544; in laryngeal catarrh, 174, 285,  
 286, 287, 299, 300; in laryngeal  
 tuberculosis, 306; in oral syphilis,  
 284; in pharyngeal catarrh, 174,  
 268, 269, 271; in pharyngeal  
 syphilis, 284; in pharyngitis sicca,  
 166; in pulmonary phthisis, 175,  
 342; in tracheal catarrh, 174; in  
 whooping cough, 319  
 Sal ammoniac vapours, penetration of,  
 into the respiratory organs, 48  
 Sales-Girons, 14, 15, 20, 44, 45, 61,  
 63, 69, 77, 80, 87, 99, 105, 106, 107,  
 153, 238, 255, 261, 315  
 Salicylic acid inhalations, 231; in  
 angina phlegmonosa, 273; in bron-  
 chiectasis, 222, 316; in bronchitis  
 putrida, 222; in broncho-pneumonic  
 ulcerations, 352, 354; in bronchor-  
 rhœa, 314; in diphtheria, 222, 278,  
 280; in laryngeal ulcers, 222, 288,  
 302; in pulmonary gangrene, 332;  
 in pulmonary phthisis, 222, 352, 354,  
 360  
 Salter, 134, 136, 178, 179  
 Saltonstall, 247

## SEC

Salts of lead inhalations in laryngeal  
 catarrh, 285, 287. V. also Acetate of  
 lead inhalations, Lead, nitrate of, in-  
 halations, Lead, oxalate of  
 Salvia decoction inhalations in angina  
 phlegmonosa, 272  
 Salvia oil inhalations, 93; in bronchial  
 catarrh, 343; in broncho-pneumonic  
 ulcerations, 354; in pulmonary  
 phthisis, 343, 354  
 Salzbrunn, v. Obersalzbrunn  
 Sambucus decoction inhalations in  
 angina phlegmonosa, 272; in coryza,  
 263  
 Sand in the respiratory organs, 31  
 Sandahl, 12, 613, 614, 648, 654, 655,  
 664, 669, 673, 674, 691, 705  
 Sannes, 368  
 Saussure, 718, 726  
 Scheele, 10  
 Scheiding, 23  
 Schinznach, inhalations of the mineral  
 water of, 238  
 Schivardi, 369  
 Schlagintweit, 615, 718, 726  
 Schlesinger, 156  
 Schmid, 22  
 Schmidt, 20, 22, 203, 210, 231, 275,  
 297, 304  
 Schneider, 14  
 Schnitzler, 17, 21, 22, 39, 42, 45, 63,  
 94, 96, 232, 368, 437, 439, 444, 477,  
 480, 516, 518, 526, 531, 554, 560,  
 574, 575  
 Schnyder, 370  
 Schöller, 132  
 Schönbein, 242  
 Schönecker, 63  
 Schreber, 440  
 Schreiber, 370, 475, 476, 481, 486, 492,  
 501, 584  
 Schreiner, 324, 327  
 Schuchardt, 21  
 Schüller, 22, 209, 211, 361  
 Schultze, 618, 682  
 Schulz, 42  
 Schutz, 613  
 Schyrmunski, 617, 673, 720  
 Scoliosis, walking and climbing in, 585  
 Scrofulosis, rarefied air with regard to,  
 731  
 Seudamore, 12, 229  
 Sea air, inhalations of, 170  
 Secretions in compressed air, 667; in  
 astringent inhalations, 148, in  
 balsamic and oil of turpentine inha-  
 lations, 202, in benzoic acid inha-  
 lations, 210, in cold water inhalations,

## SEI

- 117, in exciting alterative inhalations, 189, in solvent inhalations, 163, of the air passages, effect of cold air inhalations upon them, 111
- Seitz, 117, 132
- Selters, inhalations of the mineral waters of, in emphysema, 323
- Seltmann, 21, 34
- Sense, organs of, in compressed air, 640
- Sensitiveness of the respiratory organs towards penetrating substances, 25, 28
- Setschenow, 661
- Sieffermann, 369, 617
- Siegen, 175, 223
- Siegle, 16, 21, 44, 45, 68, 69, 70, 71, 73, 76, 80, 81, 106, 107, 137, 159, 160, 162, 264, 311, 319
- Sigg, 88
- Silver, nitrate of, inhalations, 158; in bronchial catarrh, 310, 343; in diphtheria, 159; in laryngeal catarrh, 160, 286, 287; in laryngeal tuberculosis, 307; in laryngeal ulcers, 159, 288, 303, 304; in laryngitis, 290, 296; in oral syphilis, 284; in oral ulcers, 283; in pharyngeal catarrh, 160, 267, 268, 269, 271; in pharyngeal syphilis, 284; in pharyngeal ulcers, 159, 283; in pharyngitis, 159; in pulmonary tuberculosis, 160; in whooping cough, 319
- Simonoff, 16, 367, 617, 618, 627, 642, 644, 646, 647, 648, 649, 650, 651, 653, 655, 656, 657, 658, 662, 664, 665, 666, 673, 674, 675, 679, 680, 687, 690, 693, 694, 700, 701, 703, 704, 705, 707
- Sims, 139
- Simson, 208
- Singing as respiratory exercise, 582
- Sivel, 343, 721, 726
- Skoda, 12, 124, 195, 201, 202, 312, 316, 331
- Slavjansky, 22
- Smee, 178, 181
- Smell, sense of, in compressed air, 642
- Smoler, 614
- Snow, 87, 201, 208, 227
- Soden, inhalations of the mineral waters of, 237, (in emphysema) 323
- Sodium arsenicosum, inhalations of, 233. Cf. Arsenic inhalations
- Sodium nitricum, inhalations of, 177
- Sodium sulphide, inhalations of, 180
- Solid bodies, inhalations of, action of, 51, apparatus for, 98, lung in, 52; penetration of, into the respiratory organs, 25, 29

## STE

- Solomka, 617
- Solon, 20, 203
- Solutio Fowleri, inhalations of, 233. Cf. Arsenic inhalations
- Solvent inhalations, 162; cavities in the lungs cleared by, 167; fibrinous exudations removed by, 168; in bronchial ulcers, 167; in bronchiectasis, 167; in bronchitis, 166; in cardiac affections, 167; in emphysema, 167; in inflammation of the lungs, 167; in irritative cough, 166; in laryngeal catarrh, 299; in laryngeal diphtheria, 274; in laryngeal phthisis, 167; in laryngeal tuberculosis, 306; in laryngeal ulcers, 167; in laryngitis, 166, 295; in laryngotracheitis, 166; in peribronchitis, 167; in pharyngeal catarrh, 268, 269; in pharyngitis, hyperplastica, 272, sicca, 166; in pulmonary tuberculosis, 167; in tracheal ulcers, 167; in tracheitis, 295; secretions in, 164
- Sommerbrodt, 17, 368, 471, 472, 473, 475, 476, 481, 482, 485, 500, 501, 503, 504, 531, 573
- Spasmus glottidis, v. Glottis, spasm of
- Speaking as respiratory exercise, 583
- Speck, 240, 241, 245, 249, 445, 447, 450, 452, 457, 505, 506, 507, 509, 510, 512, 513
- Spencer-Wells, 140
- Spengler, 252
- Spinal cord in rarefied air, 725
- Spinal irritation, oxygen inhalations in, 144
- Spiritus æthereus, inhalations of, 226; ætheris sulfur., ætheris sulph. camphorati, inhalations of, 88; terebinthinæ, inhalations of, 88
- Spirometer, Biedert's apparatus employed as, 414; Waldenburg's apparatus employed as, 387
- Spleen in compressed air, 664
- Sputa, inhaled substances in, 42. V. also Expectoration
- Sackfleth, 95
- Steam, penetration of, into the respiratory organs, 25, 29, 46; pulverisation of fluids by means of, 68, 71, 79, 81
- Steffen, 319
- Steinbrück, 22, 349
- Stembo, 617, 671, 672
- Stenosis, of the aortic valves, pneumatic treatment of, 570: of the ostium venosum dextrum, pneumatic treatment in, 574; of the ost. ven. sinis-

## STE

- trum, pneumatic treatment in, 567,  
Valsalva's experiment in, 583
- Stephan, 155
- Stimulating alterative inhalations, 188,  
198; in bronchial catarrhs, 191; in  
bronchitis putrida, 192; in bron-  
chorrhœa, 191; in laryngeal cancer,  
193; in laryngeal catarrh, 191; in  
laryngeal ulcers, 195; in paralysis  
of the laryngeal muscles, 194; in  
pharyngeal catarrh, 191; in pul-  
monary gangrene, 193, 196; in respi-  
ratory catarrhs, 191; in tracheal  
blennorrhœa, 192; in tracheal car-  
cinoma, 193; in tracheal ulcers, 192
- Stimulating inhalations, 93
- Stokes, 12, 20, 201, 205, 231, 330
- Stoll, 10
- Stomacacœæ, chlorate of potassium in-  
halations in, 177
- Stomatitis, v. Mouth, inflammation of
- Storch, 614, 701, 705
- Störk, 17, 39, 41, 324, 368, 369, 375,  
379, 504, 527, 531, 713
- Stramonium inhalations, 133; in  
asthma, 133, 325; in emphysema,  
323
- Stramonium paper saturated with  
nitrous solution, 179
- Strecker, 185
- Styptic inhalations, 147; in hæmop-  
tysis, 255; in næorrhages, 151
- Sublimable bodies, inhalations of, 48
- Sublimate, inhalations of, v. Mercury,  
chloride of, inhalations
- Succus caricæ papayæ, v. Carica papaya
- Suchorsky, 654
- Suffitus, 9
- Sulphate of copper, inhalations of, 162;  
in laryngitis, 162, ulcerosa, 162; in  
phthisis, 162; in pulmonary gan-  
grene, 162
- Sulphides of potassium and sodium,  
inhalations of, 180, (in catarrhs, la-  
ryngeal irritation, convulsive cough)  
180
- Sulphur water inhalations, 237; in  
laryngeal catarrh, 285; in pharyn-  
geal catarrh, 271; in pulmonary  
phthisis, 238
- Sulphuretted hydrogen inhalations,  
253, in asthma, blennorrhœas, bron-  
chial catarrh, catarrhs, emphysema,  
frontal catarrh, laryngeal catarrh,  
nasal catarrh, pharyngeal catarrh,  
phthisis pituitosa and tuberculosa  
tracheal catarrh, whooping cough,  
254

## TAP

- Sulphuric ether, inhalations of, 223.  
V. also Ether inhalations
- Sweet almond oil inhalations, 125; in  
catarrh of the respiratory organs,  
340; in pulmonary phthisis, 340
- Syncope, caustic ammonia inhalations  
in, 226; ether inhalations in, 226;  
nerve-exciting inhalations in, 225
- Syphilis of the larynx, v. Laryngeal  
syphilis; of the oral cavity, v.  
Mouth, syphilis of; of the pharynx,  
v. Pharyngeal syphilis; of the respi-  
ratory organs, iodine inhalations in,  
229, mercury inhalations in, 231,  
opium inhalations in, 132
- Szohner, 370

TABARIÉ, 13, 612, 618, 619, 631,  
656, 710

- Tan used for inhalations, 88
- Tannic acid glycerine used for inhala-  
tions, 155
- Tannic acid, inhalations of, v. Tannin  
inhalations
- Tannin inhalations, 153; anæsthesia of  
the pharyngeal and laryngeal mucous  
membrane by means of, 309; com-  
bined with common salt inhalations,  
154; in apex catarrh, 342; in bron-  
chial catarrh, 154, 310, 392, 343; in  
bronchial hæmorrhage, 260; in bron-  
chiectasis, 154, 316; in bronchitis  
putrida, 314; in bronchopneumonic  
ulcerations, 356; in bronchorrhœa,  
154, 314; in catarrhs, 154; in croup,  
155; in desquamative pneumonia,  
344; in diphtheria, 155; in emphy-  
sema, 323; in hæmorrhages of the  
oral cavity, 258; in hæmorrhages  
of the respiratory organs, 155; in  
laryngeal abscess, 290; in laryngeal  
catarrh, 154, 285, 286, 287, 299, 300;  
in laryngeal ulcers, 289, 303; in  
laryngitis, 290, 296; in œdema of  
the glottis, 155; in paresis of the  
vocal cords, 309; in pharyngeal ca-  
tarrh, 154, 267, 268; in pharyngeal  
hæmorrhages, 258; in pharyngeal  
syphilis, 284; in pulmonary gan-  
grene, 155, 333; in pulmonary hæ-  
morrhage, 155, 261; in pulmonary  
phthisis, 154, threatening, 336, 342,  
343, 344, 356; in syphilis of the  
oral cavity, 284; in ulcerations,  
catarrhal, 154; in whooping cough,  
155, 319
- Tappeiner, 215, 337

## TAR

- Tar fumigations, 199. V. also Tar inhalations
- Tar inhalations, 93, 198; combined with chloride of iron inhalations, 157; in bronchial catarrh, 315, 343; in bronchiectasis, 200, 316, 330; in bronchitis putrida, 196, 198, 200, 315; in bronchopneumonic ulcerations, 354; in bronchorrhœa, 200, 312, 315; in emphysema, 323; in inflammation of the lungs, 198, 330; in laryngeal phthisis, 198, 306; in pneumomycosis, 360; in pulmonary blennorrhœa, 198; in pulmonary gangrene, 200; in pulmonary phthisis, 198, 200, 343, 354, 360
- Tar respirator, 87
- Tar vapour added to compressed air in inhalations, 519
- Tar water, inhalations of, v. Tar inhalations
- Taste, sense of, in compressed air, 642
- Tavernier, 16, 38, 42
- Tea, infusion of, inhalations in coryza, 263
- Temperature, of inhaled fluids with regard to the respiratory organs, 46, 57; of the body, v. Body temperature; of pulverised fluids, 78, 79, 80
- Tepid water inhalations in bronchial catarrh, 309, 311; in coryza, 265; in laryngeal catarrh, 285; in pharyngeal catarrh, 267; in whooping cough, 329
- Tervillon, 138, 139
- Tetanus, amyl nitrite inhalations in, 146; chloroform inhalations in, 140
- Tetraethyl-ammonium-hydroxide, inhalations of, 156. in bronchial diphtheria and bronchial croup, 317, in laryngeal diphtheria, 294
- Thaon, 370
- Theile, 141
- Thiéry, 134
- Thoracentesis, inspiration of compressed air after, 553. V. Thoracic fistula
- Thoracic fistula, pneumatic treatment with regard to, 604. Cf. Thoracentesis
- Thorax, compression of, manual, 608; diminution of air pressure on the surface of, 589; in compressed air, 650; in expiration into rarefied air, 455, 458; in inspiration of compressed air, 443; in inspiration of rarefied air, 452; inspiratory dilatation of, 575. (forced) 596; in prolonged expiration, 580; paralytic, pneumatic treatment of, 524

## TRA

- Thorner, 22, 216, 320, 321
- Thrush, chlorate of potassium inhalations in, 177
- Thymol inhalations, 93, 222; in bronchitis putrida, 313, 314; in bronchopneumonic ulcerations, 352, 355; in bronchorrhœa, 313; in diphtheria, 223; in laryngeal ulcers, 288; in pulmonary gangrene, 332; in pulmonary phthisis, 352, 354; in whooping cough, 322
- Tiermann, 65
- Tincturi ferri pomati, inhalations of, for averting consumption, 336, in bronchial catarrh, 343
- Tinnitus aurium, amyl nitrite inhalations in, 130, 147
- Tissandier, 726, 727
- Tissue change, in compressed air, 673; in rarefied air, 722
- Tobacco inhalations, 136; in asthma, 326
- Tobacco, leaves of, saturated with solution of nitre and used for smoking, 179
- Tobold, 17, 21, 38, 156, 368, 375, 394, 517
- Tolu balsam inhalations, 93, 203; in bronchopneumonic ulcerations, 354; in bronchorrhœa, 312; in laryngeal ulcers, 203, 302; in paresis of the vocal cords, 308; in pulmonary phthisis, 354; in tracheal ulcers, 203
- Tonsillitis, v. Angina tonsillaris
- Toricelli, 9
- Touch, sense of, in compressed air, 642
- Toulmouche, 12, 204
- Trachea, inhalations with regard to, 102
- Tracheal cancer, inhalations in, 193
- Tracheal catarrh, althæa infusion inhaled in, 340; astringent inhalations in, 151; carbonate of potassium inhalations in, 179; carbonate of soda inhalations in, 176; cold air inhalations in, 113, 340; cold water inhalations in, 118; copaiva balsam inhalations in, 88; emollient inhalations in, 121, 340; Ems water inhalations in, 236, 249; glycerine inhalations in, 340; gum arabic inhalations in, 340; Peruvian balsam inhalations in, 88; respirator, medicated, in, 88; sal ammoniac inhalations in, 174; salt, common, inhalations in, 171, 340; sulphate of zinc inhalations in, 162; sulphur water inhalations in, 254; sweet almond oil inhalations in,



## TRA

- 340; turpentine, oil of, inhalations in, 201  
 Tracheal croup, v. Croup  
 Tracheal diphtheria, inhalations in, 290; cold water inhalations in, 191. V. also Diphtheria  
 Tracheal exudations, solvent inhalations in, 168  
 Tracheal fistula, foreign bodies detected in the respiratory organs by means of, cf. Tracheotomy  
 Tracheal hæmorrhage, inhalations in, 259  
 Tracheal hyperæsthesia, conium inhalations in, 133  
 Tracheal stenosis, pneumatic treatment of, 527  
 Tracheal ulcers, balsamic inhalations in, 203; copaiva balsam inhalations in, 203; exciting alterative inhalations in, 192; Peruvian balsam inhalations in, 203; solvent inhalations in, 167; Tolu balsam inhalations in, 203  
 Tracheitis, antiseptic inhalations in, 296; astringent inhalations in, 296; boracic acid inhalations in, 296; carbolic acid inhalations in, 296; carbonate of potassium inhalations in, 295; cold air inhalations in, 113, 115; Ems water inhalations in, 236; inhalations in, 295; lactic acid inhalations in, 295; lime water inhalations in, 295; lithium inhalations in, 295; neurine inhalations in, 295; papayotine inhalations in, 295; solvent inhalations in, 166, 295  
 Tracheotomy, detection of foreign bodies in the trachea by means of, 40; inhalation through the tracheal orifice after, 292, 295  
 Transudations in cold air inhalations, 111  
 Traube, 22, 33, 214, 315, 504  
 Treutler, 22, 249, 250, 345, 347, 349, 350, 368, 375  
 Tricuspidal valve, insufficiency of, pneumatic treatment in, 514  
 Trier, 614  
 Triger, 613  
 Trimethyl-vinyl-ammonium hydroxide, v. Neurine  
 Trousseau, 13, 16, 20, 134, 154, 155, 162, 182, 233, 333  
 Tuberculosis of the larynx, v. Laryngeal tuberculosis; of the lungs, v. Lungs, tuberculosis of  
 Tubuli antasthmatici, 134, 326

## VER

- Türk, 162, 259  
 Tuller, 214, 313  
 Turnbull, 138, 139  
 Turpentine, oil of, addition of, to compressed air, 519, 532, 534  
 Turpentine, oil of, inhalations, 93, 200; in aphonia, paralytic, 201; in bronchial catarrh, 88, 343, 532, 534, 543; in bronchiectasis, 316, 330; in bronchitis, 196, 201, 313, 314; in bronchopneumonic ulcerations, 352, 354; in bronchorrhœa, 88, 312, 313; in emphysema, 323, 543; in laryngeal catarrh, 201; in laryngeal tuberculosis, 306; in laryngitis, 330; in paresis of the vocal cords, 308; in pulmonary gangrene, 201, 331; in pulmonary phthisis, 200, 201, 343, 352, 354, combined with inhalations of compressed air, 519; in tracheal catarrh, 201; secretions in, 202  
 Tutschek, 614, 649
- U**L CERATION, broncho-pneumonic, v. Broncho-pneumonic ulcerations; catarrhal, tannic acid inhalations in, 154 Cf Ulcers  
 Ulcers, emollient inhalations in, 122; of the oral cavity, v. Mouth ulcers; of the pharynx, v. Pharyngeal ulcers; of the respiratory mucous membrane, opium inhalations in, 132; oxygen inhalations in, 246  
 Urea, excretion of, in compressed air, 676; in rarefied air, 722  
 Uric acid diathesis, oxygen inhalations in, 244  
 Urine, inhaled substances in, 42; after use of carbolic acid, 213  
 Urine, secretion of, after inspiration of compressed air, 555; in the pneumatic chamber, 663
- V**ALERIAN oil, inhalations of, 93  
 Valsalva's experiment, 468, 469, 480, 481, 482, 486, 487, 488, 580, 583, 584  
 Vapourised inhalations. action of, 60  
 Varrentrapp, 20, 141, 142  
 Vascular excitement, inhalations with regard to, 100  
 Veins in compressed air, 654, 666; in expiration into rarefied air, 495; in inspiration of compressed air, 478  
 Verbascum flowers, inhalations of infusion of, 125

## VER .

- Vertebral canal in compressed air, 665  
 Vertebral column, curvatures of, walking and climbing in, 585  
 Vervet, sulphuretted hydrogen inhalations at, 254  
 Vessels, v. Blood vessels, Lymph vessels  
 Vichy, carbonic acid inhalations at, 252; mineral water inhalations at, 236  
 Villaret, 21, 34  
 Virchow, 235  
 Vix, 22, 210  
 Vocal cords, catarrh of, inhalations in, 285  
 Vocal cords, inhalations with regard to, 24  
 Vocal cords, paresis of, inhalations in, of asafoetida, 227, of alum, oleum pini silv., oleum pini pumil., Peruvian balsam, tannin, oil of turpentine, Tolu balsam, 308. V. also Aphonia, Paresis of the laryngeal muscles  
 Vogel, 227  
 Vogler, 21, 162, 234, 252  
 Voice in compressed air, 641  
 Von Elsässer, 614  
 Von Humboldt, 711, 626  
 Von Ins, 23, 34, 53  
 Von Liebig, 16, 21, 615, 616, 617, 618, 623, 624, 627, 638, 648, 662, 670, 686, 692  
 Von Mosengeil, 587  
 Von Pettenkofer, 623, 628  
 Von Pfeufer, 141  
 Von Rotteck, 20  
 Von Vivenot, 16, 613, 614, 622, 623, 628, 633, 637, 638, 644, 648, 649, 650, 651, 654, 655, 656, 657, 658, 659, 660, 661, 662, 664, 665, 669, 671, 672, 675, 692, 705, 708, 715, 719, 725  
 Von Wänker, 20  
 Von Ziemssen, 356, 358

**W**ALDENBURG, 7, 16, 17, 21, 22, 45, 63, 69, 79, 84, 94, 133, 134, 138, 155, 156, 157, 159, 160, 172, 175, 180, 182, 184, 200, 206, 229, 232, 233, 236, 242, 246, 256, 261, 284, 312, 316, 323, 368, 369, 370, 371, 373, 375, 380, 387, 388, 392, 393, 394, 410, 437, 439, 443, 444, 446, 447, 449, 453, 456, 458, 459, 469, 470, 473, 476, 477, 478, 479, 480, 481, 486, 487, 488, 493, 494,

## WHO

- 495, 496, 498, 502, 514, 516, 517, 520, 526, 527, 528, 532, 545, 548, 549, 553, 559, 562, 563, 566, 568, 570, 572, 574, 575, 584, 585, 589, 611, 616, 618, 658, 660, 663, 713, 715, 719  
 Walking, respiration in, 585  
 Walz, 14  
 'Wanne,' pneumatic, 588, 590, 591  
 Warm water inhalations, 124; in angina phlegmonosa, 272; in bronchial diphtheria, 318; in bronchorrhœa, 313  
 Warmth, of inhaled fluids, its action on the respiratory organs, 58; of the body, v. Body temperature  
 Watelle, 613  
 Water bellows, apparatus for respiratory treatment on the principle of, 417  
 Water fennel in the Espic cigarettes, 525  
 Water mist, inhalations of, 47, 60, 83, 124  
 Watt, 19  
 Weber, 20, 185, 324, 468, 583, 615, 642, 726  
 Wedemann, 21, 160, 175, 319  
 Weil, 17, 368, 375, 393, 516  
 Weilbach, mineral water of, used for inhalations, 238, 254  
 Wenz, 21  
 Wenzel, 23  
 Werner, 20  
 Whistling as respiratory exercise, 583  
 Whooping cough, alum inhalations in, 319; benzoate of soda inhalations in, 322; benzoic acid inhalations in, 322; benzole dioxide inhalations in, 221; benzole inhalations in, 208; bromide of potassium inhalations in, 138, 319; carbolic acid inhalations in, 216, 319, 320; carbonate of potassium inhalations in, 319; carbonate of soda inhalations in, 319; cherry laurel water inhalations in, 136; chloride of iron inhalations in, 319; chloroform inhalations in, 88, 140; coal gas inhalations in, 319; ether inhalations in, 88; hyoscyamus inhalations in, 133, 319; hypermanganate of potassium in, 207; inhalations in, 318; mucilaginous inhalations in, 319; narcotic inhalations in, 129, 319; olive oil inhalations in, 125; opium inhalations in, 319; pneumatic treatment of, 719; prussic acid inhalations in, 136; quinine in-

## WIE

- halations in, 320; respirator, medicated, in, 89; sal ammoniac inhalations in, 319; salt, common, inhalations in, 319; silver, nitrate of, inhalations in, 319; sulphuretted hydrogen inhalations in, 254; tannic inhalations in, 155, 319; tepid water inhalations in, 319; thymol inhalations in, 322
- Wietfeld, 21, 319
- Will, 140
- Willis, 9, 124
- Wine, spirits of, inhalations combined with ammoniated inhalations, 182; in coryza, 264
- Wintrich, 67, 174, 324
- Wistinghausen, 21, 233, 234, 323
- Woillez, 588
- Wood, 145
- Wounds in the air passages, emollient inhalations in, 123

## ZUN

Wucherer, 20, 141

YOUNG, 35

ZDEKAUER, 16, 20, 41

Zenker, 21, 34

Ziegler, 13, 214, 227

Zinc, sulphate of, inhalations, 161; in aphonia, 162; in bronchial catarrh, 162; in broncho-pneumonic ulcerations, 356; in bronchorrhœa, 162; in hæmorrhages of the air passages, 162; in laryngeal catarrh, 161, 285, 287, 299; in laryngeal ulcers, 288, 303; in laryngitis, 296; in pharyngeal catarrh, 162; in pulmonary phthisis, 162, 356; in tracheal catarrh, 162

Zuntz, 370, 466, 467, 496, 497, 501

END OF THE THIRD VOLUME.

LONDON: PRINTED BY  
SPOTTISWOODE AND CO., NEW-STREET SQUARE  
AND PARLIAMENT STREET



# SMITH, ELDER, & CO.'S PUBLICATIONS.

---

- A GUIDE to THERAPEUTICS.** By ROBERT FARQUHARSON, M.P., M.D. Edin., F.R.C.P. Lond., late Lecturer on Materia Medica at St. Mary's Hospital Medical School, &c. Third Edition. Crown 8vo. 7s. 6d.
- COMMENTARY on the BRITISH PHARMACOPEIA.** By WALTER GEORGE SMITH, M.D., Fellow and Censor of King and Queen's College of Physicians in Ireland; Examiner in Materia Medica, Q.U.I.; Assistant Physician to the Adelaide Hospital. Crown 8vo. 12s. 6d.
- OCULAR THERAPEUTICS.** By L. DE WECKER, Professor of Clinical Ophthalmology, Paris. Translated and Edited by LITTON FORBES, M.A., M.D., F.R.G.S., late Clinical Assistant, Royal London Ophthalmic Hospital. With Illustrations. Demy 8vo. 16s.
- A TREATISE on THERAPEUTICS.** Comprising Materia Medica and Toxicology, with Especial Reference to the Application of the Physiological Action of Drugs to Clinical Medicine. By H. C. WOOD, jun., M.D. New Edition. Enlarged. 8vo. 14s.
- A SYSTEM of OBSTETRIC MEDICINE and SURGERY.** Theoretical and Clinical, for the Student and Practitioner. By ROBERT BARNES, M.D., Obstetric Physician to St. George's Hospital; Consulting Physician to the Chelsea Hospital for Women, &c.; and FANCOURT BARNES, M.D., Physician to the Royal Maternity Charity, and to the British Lying-in Hospital; Assistant Obstetric Physician to the Great Northern Hospital; Physician to the Chelsea Hospital for Women. The Section on Embryology contributed by Professor MILNES MARSHALL. Vol. I., 8vo. profusely Illustrated, price 15s.
- A TREATISE on the SCIENCE and PRACTICE of MIDWIFERY.** By W. S. PLAYFAIR, M.D., F.R.C.P., Physician-Accoucheur to H.L. and R.H. the Duchess of Edinburgh; Professor of Obstetric Medicine in King's College; Physician for the Diseases of Women and Children to King's College Hospital; Consulting Physician to the General Lying-in Hospital, and to the Evelina Hospital for Children; late President of the Obstetrical Society of London; Examiner in Midwifery to the University of London, and to the Royal College of Physicians. Fourth Edition. 2 vols. demy 8vo. With 166 Illustrations. 25s.
- A MANUAL of MIDWIFERY for MIDWIVES.** By FANCOURT BARNES, M.D. Aber., M.R.C.P. Lond., Physician to the Royal Maternity Charity; Physician to the British Lying-in Hospital; Obstetric Physician to the Great Northern Hospital; Physician to the Chelsea Hospital for Women. Second Edition. Crown 8vo. with numerous Illustrations, 6s.
- DISEASES of WOMEN; including their Pathology, Causation, Symptoms, Diagnosis and Treatment.** A Manual for Students and Practitioners. By ARTHUR W. EDM. M.D. Lond., F.R.C.P. Second Edition, thoroughly revised. With numerous Illustrations. Demy 8vo. 12s. 6d.
- A SYNOPTICAL GUIDE to the STUDY of OBSTETRICS.** Being an Aid to the Student in the Class-room, in Private Study, and in Preparing for Examinations. By ROBERT BARNES, M.D., Obstetric Physician to St. George's Hospital, Consulting Physician to the Chelsea Hospital for Women, &c. Crown 8vo. 5s.
- CLINICAL and PATHOLOGICAL OBSERVATIONS on TUMOURS of the Ovary, Fallopian Tube, and Broad Ligament.** By ALBAN H. G. DORAN, F.R.C.S., Assistant Surgeon to the Samaritan Free Hospital, formerly Anatomical and Pathological Assistant to the Museum of the Royal College of Surgeons of England. With 32 Illustrations. 8vo. 10s. 6d.
- THE QUESTION of REST for WOMEN DURING MENSTRUATION.** By MARY PUTNAM JACOBI, M.D., Professor of Materia Medica in the Women's Medical College, New York. With Illustrations. Demy 8vo. 12s.
- GENERAL and DIFFERENTIAL DIAGNOSIS of OVARIAN TUMOURS,** with Special Reference to the Operation of Ovariotomy, and Occasional Pathological and Therapeutical Considerations. By WASHINGTON L. ATLEE, M.D. With 39 Illustrations. 8vo. 20s.
- A PRACTICAL TREATISE on the DISEASES of the HEART and GREAT VESSELS,** including the Principles of their Physical Diagnosis. By WALTER HAYLE WALSH, M.D. Fourth Edition, thoroughly revised and greatly enlarged. Demy 8vo. 16s.
- A PRACTICAL TREATISE on DISEASES of the LUNGS,** including the Principles of Physical Diagnosis and Notes on Climate. By WALTER HAYLE WALSH, M.D. Fourth Edition, revised and much enlarged. Demy 8vo. 16s.

---

London: SMITH, ELDER, & CO., 15 Waterloo Place.

# SMITH, ELDER, & CO.'S PUBLICATIONS.

---

- A TREATISE on the THEORY and PRACTICE of MEDICINE.** By JOHN SYER BRISTOWE, M.D. Lond., Fellow and formerly Censor of the Royal College of Physicians; Senior Physician to, and Joint Lecturer on Medicine at, St. Thomas's Hospital; President of the Society of Medical Officers of Health; Examiner in Medicine to the Royal College of Surgeons; formerly Examiner in Medicine to the University of London, and Lecturer on General Pathology and on Physiology at St. Thomas's Hospital. Fifth Edition, 8vo. price 21s.
- A PRACTICAL TREATISE on URINARY and RENAL DISEASES,** including Urinary Deposits. Illustrated by numerous cases and Engravings. Fourth Edition, Revised and Enlarged. By WILLIAM ROBERTS, M.D., F.R.S., Fellow of the Royal College of Physicians, London; Professor of Medicine at the Victoria University; Consulting Physician to the Manchester Royal Infirmary. Assisted by ROBERT MAGUIRE, M.D., Lond., Member of the Royal College of Physicians, London; Physician to Out-patients, St. Mary's Hospital, London; late Pathologist to the Manchester Royal Infirmary. Small 8vo. 12s. 6d.
- On FUNCTIONAL DERANGEMENTS of the LIVER.** By C. MURCHISON, M.D., LL.D., F.R.S., Physician and Lecturer on Medicine, St. Thomas's Hospital, and formerly on the Medical Staff of H.M.'s Bengal Army. Second Edition. Crown 8vo. 5s.
- AUSCULTATION and PERCUSSION,** together with the other Methods of Physical Examination of the Chest. By SAMUEL GEE, M.D. With Illustrations. Third Edition. Fcp. 8vo. 6s.
- A TEXT-BOOK of ELECTRICITY in MEDICINE and SURGERY,** for the Use of Students and Practitioners. By GEORGE VIVIAN POORE, M.D. Lond., M.R.C.P., &c.; Assistant-Physician to University College Hospital; Senior Physician to the Royal Infirmary for Children and Women. Crown 8vo. 8s. 6d.
- SKIN DISEASES;** including their Definitions, Symptoms, Diagnosis, Prognosis, Morbid Anatomy, and Treatment. A Manual for Students and Practitioners. By MALCOLM MORRIS, Surgeon to the Skin Department, St. Mary's Hospital, and Lecturer on Dermatology in the Medical School. With Illustrations. Crown 8vo. 7s. 6d.
- DISEASES of the NERVOUS SYSTEM,** their Prevalence and Pathology. By JULIUS ALTHAUS, M.D., M.R.C.P. Lond., Senior Physician to the Hospital for Epilepsy and Paralysis, Regent's Park; Fellow of the Royal Medical and Chirurgical Society, Statistical Society, and the Medical Society of London; Member of the Clinical Society; Corresponding Member of the Société d'Hydrologie Médicale de Paris; of the Electro-Therapeutical Society of New York; &c. &c. Demy 8vo. 7s. 6d.
- The LOCALISATION of CEREBRAL DISEASE.** By DAVID FERRIER, M.D., F.R.S., Assistant Physician to King's College Hospital, Professor of Forensic Medicine, King's College. With numerous Illustrations. 8vo. 7s. 6d.
- HOUSEHOLD MEDICINE:** containing a Familiar Description of Diseases, their Nature, Causes and Symptoms, the most approved Methods of Treatment, the Properties and Uses of Remedies, &c., and Rules for the Management of the Sick Room. Expressly adapted for Family Use. By JOHN GARDINER, M.D. Eleventh Edition, with numerous Illustrations. Demy 8vo. 12s. 6d.
- The ELEMENTS of PHYSIOLOGICAL and PATHOLOGICAL CHEMISTRY.** A Handbook for Medical Students and Practitioners. Containing a General Account of Nutrition, Foods, and Digestion, and the Chemistry of the Tissues, Organs, Secretions and Excretions of the Body in Health and in Disease. Together with the Methods for Preparing or Separating their Chief Constituents, as also for their Examination in Detail, and an Outline Syllabus of a Practical Course of Instruction for Students. By T. CRANSTON CHARLES, M.D., F.C.S., &c., Master of Surgery, Lecturer on Practical Physiology, St. Thomas's Hospital, London; late Medical Registrar, St. Thomas's Hospital; and formerly Assistant-Professor and Demonstrator of Chemistry and Chemical Physics, Queen's College, Belfast, &c. &c. With 38 Woodcut Illustrations and 1 Chromo-lithograph. Demy 8vo. 21s.
- ELEMENTS of HUMAN PHYSIOLOGY.** By Dr. L. HERMANN, Professor of Physiology in the University of Zürich. Second Edition. Entirely recast from the Sixth German Edition, with very copious additions, and many additional Woodcuts, by ARTHUR GAMGEE, M.D., F.R.S., Brackenbury Professor of Physiology in Owen's College, Manchester, and Examiner in Physiology in the University of Edinburgh. Demy 8vo. 16s.

---

London: SMITH, ELDER, & CO., 15 Waterloo Place.

